

User Manual



AWG710 & AWG710B 4 GS/s / 4.2 GS/s Arbitrary Waveform Generator

071-1413-01

This document supports firmware version 4.00 and above.

www.tektronix.com

Copyright © Tektronix Japan, Ltd. All rights reserved.
Copyright © Tektronix, Inc. All rights reserved.

Tektronix products are covered by U.S. and foreign patents, issued and pending. Information in this publication supercedes that in all previously published material. Specifications and price change privileges reserved.

Tektronix, Inc., P.O. Box 500, Beaverton, OR 97077

TEKTRONIX and TEK are registered trademarks of Tektronix, Inc.

WARRANTY

Tektronix warrants that the products that it manufactures and sells will be free from defects in materials and workmanship for a period of one (1) year from the date of shipment. If a product proves defective during this warranty period, Tektronix, at its option, either will repair the defective product without charge for parts and labor, or will provide a replacement in exchange for the defective product.

In order to obtain service under this warranty, Customer must notify Tektronix of the defect before the expiration of the warranty period and make suitable arrangements for the performance of service. Customer shall be responsible for packaging and shipping the defective product to the service center designated by Tektronix, with shipping charges prepaid. Tektronix shall pay for the return of the product to Customer if the shipment is to a location within the country in which the Tektronix service center is located. Customer shall be responsible for paying all shipping charges, duties, taxes, and any other charges for products returned to any other locations.

This warranty shall not apply to any defect, failure or damage caused by improper use or improper or inadequate maintenance and care. Tektronix shall not be obligated to furnish service under this warranty a) to repair damage resulting from attempts by personnel other than Tektronix representatives to install, repair or service the product; b) to repair damage resulting from improper use or connection to incompatible equipment; c) to repair any damage or malfunction caused by the use of non-Tektronix supplies; or d) to service a product that has been modified or integrated with other products when the effect of such modification or integration increases the time or difficulty of servicing the product.

THIS WARRANTY IS GIVEN BY TEKTRONIX IN LIEU OF ANY OTHER WARRANTIES, EXPRESS OR IMPLIED. TEKTRONIX AND ITS VENDORS DISCLAIM ANY IMPLIED WARRANTIES OF MERCHANTABILITY OR FITNESS FOR A PARTICULAR PURPOSE. TEKTRONIX' RESPONSIBILITY TO REPAIR OR REPLACE DEFECTIVE PRODUCTS IS THE SOLE AND EXCLUSIVE REMEDY PROVIDED TO THE CUSTOMER FOR BREACH OF THIS WARRANTY. TEKTRONIX AND ITS VENDORS WILL NOT BE LIABLE FOR ANY INDIRECT, SPECIAL, INCIDENTAL, OR CONSEQUENTIAL DAMAGES IRRESPECTIVE OF WHETHER TEKTRONIX OR THE VENDOR HAS ADVANCE NOTICE OF THE POSSIBILITY OF SUCH DAMAGES.

Table of Contents

Table of Contents	i
General Safety Summary	xvii
Preface	xix
Manual Structure	xix
Conventions	xx
Related Manuals	xxi
Contacting Tektronix	xxi

Getting Started

Getting Started	1-1
Product Description	1-1
Incoming Inspection	1-4
Power Cord Options	1-5
Language Options	1-5
Accessories	1-6
Options	1-8
Installation	1-10
Repackaging for Shipment	1-16

Operating Basics

Operating Basics	2-1
Controls and Connectors	2-1
Menu Operations	2-8
Numeric Input	2-12
Text Input	2-14
Shortcut Controls	2-15
File Management	2-17
Quick View	2-24
Editor Overview	2-26
Setup Overview	2-34
Theory of Operation	2-41
Signal Edit Process	2-46
Tutorials	2-49
Tutorial 1: Instrument Setup	2-51
Tutorial 2: Loading and Outputting a Sample Waveform	2-53
Tutorial 3: Creating and Editing Standard Function Waveforms	2-56
Tutorial 4: Editing a Waveform Using Quick Editor	2-63
Tutorial 5: Using the Equation Editor	2-67
Tutorial 6: Creating and Running Waveform Sequences	2-70

Reference

Reference	3-1
Overview	3-1
Menu Structures	3-3

Setup Menu Hierarchy	3-4
EDIT Menu Hierarchy	3-13
APPL Menu Hierarchy	3-26
Utility Menu Hierarchy	3-30
The Setup Menu Screen	3-33
Setup Menu Screen Elements	3-33
The Waveform/Sequence Menu	3-36
The Vertical Menu	3-38
The Horizontal Menu	3-40
The Run Mode Menu	3-44
The Trigger Menu	3-46
The Save/Restore Menu	3-48
The Extended Operation Menu	3-50
Waveform, Pattern and Sequence Waveform Output	3-51
The Graphical Waveform Editor	3-55
Editor Screen Elements	3-55
The File Menu	3-58
The Operation Menu	3-59
The Tools Menu	3-72
The Zoom/Pan Menu	3-81
The Window Menu	3-82
The Settings Menu	3-82
The Pattern Editor	3-85
About Waveform and Pattern Files	3-85
Starting the Pattern Editor	3-86
The File Menu	3-87
The Operation Menu	3-87
The Tools Menu	3-87
The Zoom/Pan Menu	3-91
The Window Menu	3-91
The Settings Menu	3-91
The Undo! Command	3-91
Selecting Data Bits to Edit	3-92
Defining Edit Area	3-93
Creating a Pattern	3-94
Creating Standard Patterns	3-95
Inserting Data From Files	3-96
Set Pattern...	3-96
Quick Editing	3-99
Screen Display	3-99
Quick Edit Mode	3-100
Quick Edit Mechanism	3-100
About Smoothing	3-101
Quick Controls	3-101
Starting Quick Edit	3-102
Exiting Quick Edit	3-103
Setting Parameters	3-103
Moving the Cursor	3-104
Renewing Edit Buffer	3-104
About Undo	3-104

The Table Editor	3-105
Opening The Table Editor	3-105
Editing The Table Data	3-106
The Equation Editor	3-109
Starting the Equation Editor	3-110
Using the Equation Editor	3-111
Entering Keywords and Functions	3-114
Compiling Equations	3-115
The Sequence Editor	3-117
Starting the Sequence Editor	3-117
Sequence Table Editing	3-120
Sequence Table Fields	3-122
The APPL Menu	3-131
Disk Application	3-131
Network Application	3-140
Jitter Composer Application	3-147
The UTILITY Window	3-155
External Keyboards	3-155
Setting General Purpose Knob Direction	3-156
Formatting a Floppy Disk	3-157
Displaying Disk Usage	3-157
Screen Display Enable/Disable	3-158
Focused Color	3-158
Displaying Instrument Status	3-158
Internal Clock (Date and Time)	3-159
Resetting the Instrument	3-159
Connecting to a GPIB Network	3-160
Ethernet Networking	3-162
Hardcopy	3-170
Calibration and Diagnostics	3-172
Upgrading the System Software	3-179
Capturing Waveforms	3-181
Possible Instruments	3-181
Basic Concept on Communication for Capturing	3-181
Procedures for Capturing Waveforms	3-182
About Transferred Files	3-184
Waveform Programming Language	3-185
Command Syntax	3-185
User-Defined Variables	3-186
Waveform Files	3-187
Command Descriptions	3-189
Bpf()	3-189
Brf()	3-190
Code()	3-191
Conv()	3-191
Copy()	3-192
Corr()	3-192
Data()	3-193
Delete()	3-194
Diff()	3-194

Expand()	3-195
Extract()	3-195
For (Control Statement)	3-196
Hpf()	3-197
If (Control Statement)	3-198
Integ()	3-198
Join()	3-199
Lpf()	3-199
Math Functions	3-200
Math Operators	3-202
Norm()	3-203
Pn()	3-203
Rename()	3-204
Variables (predefined)	3-205
Write()	3-206
Programming Examples	3-207
File Conversion	3-219
Import	3-219
Export	3-221
Convert between Waveform and Pattern	3-221
Executing File Conversion	3-222
File Management	3-225
Command Summary	3-225
Path Name	3-225
File Operations	3-226
File Operation in Double Windows	3-230
FG Mode	3-233
Change the generator mode	3-234
Parameters	3-236
Waveform Mixing Mode	3-241
Change the generator mode	3-242
File... menu	3-243
Waveform Mixing parameters	3-245
Update	3-246
Save/Restore Setup	3-247
Operation Flow	3-247
Synchronous Operation Mode (AWG710B only)	3-249
restrictions	3-250
Connecting the cables	3-250
Change the generator mode	3-252
Setup screen	3-253
Setting a Slave IP address	3-254
Testing the Network Connection	3-254
Connection with Slave	3-255
Error messages on connection	3-255
Trigger Timing Calibration	3-256
Save/Restore Setup	3-257
Operation Flow	3-257

Appendices

Specifications (AWG710B)	A-1
Electrical Specification	A-2
Certification and Compliances	A-25
Specifications (AWG710)	A-27
Electrical Specification	A-28
Certification and Compliances	A-40
Performance Verification (AWG710B)	B-1
Conventions	B-1
Self Tests	B-2
Performance Tests	B-6
Operating Mode Tests	B-13
Amplitude and Offset Accuracy Tests (Normal Out), (except option 02)	B-19
Amplitude, Offset Accuracy and Rise Time Tests (Direct DA Out), (except option 02)	B-23
Amplitude, Offset Accuracy and Rise Time Tests (for option 02)	B-27
Pulse Response Tests (Normal Out), (except option 02)	B-31
Trigger Input Tests	B-33
Event Input and Enhanced Mode Tests	B-37
External Clock Input and VCO Out Output Tests	B-46
VCO OUT Output Frequency and 10 MHz Reference Input Tests	B-48
Marker Output Tests	B-50
Synchronous Operation Tests	B-52
Performance Verification (AWG710)	B-55
Conventions	B-55
Self Tests	B-56
Performance Tests	B-60
Operating Mode Tests	B-66
Amplitude and Offset Accuracy Tests (Normal Out), (except option 02)	B-72
Amplitude, Offset Accuracy and Rise Time Tests (Direct DA Out), (except option 02)	B-77
Amplitude, Offset Accuracy and Rise Time Tests (for option 02)	B-81
Pulse Response Tests (Normal Out), (except option 02)	B-85
Trigger Input Tests	B-87
Event Input and Enhanced Mode Tests	B-91
1/4 Clock Frequency and 10 MHz Reference Input Tests	B-98
Marker Output Tests	B-100
Inspection and Cleaning	C-1
Sample Waveforms	D-1
Waveform File Descriptions	D-2
File Transfer Interface Outline	E-1
Miscellaneous	F-1
Sampling Theorem	F-1
Differentiation	F-1
Integration	F-3
Convolution	F-4
Correlation	F-5
Code Conversion	F-7
Examples	F-8

Sequence File Text Format	G-1
Header	G-1
Line Descriptions	G-1
Jump Settings	G-3
Examples	G-4

Index

Index	Index-1
--------------------	----------------

List of Figures

Figure 1-1: Rear panel power switch, fuse holder, and power connector	1-13
Figure 1-2: Location of the ON/STBY switch	1-14
Figure 2-1: Front panel controls (AWG710)	2-2
Figure 2-2: Front panel controls (AWG710B)	2-3
Figure 2-3: Front panel keypad area	2-4
Figure 2-4: Front panel trigger and output controls	2-5
Figure 2-5: Rear panel signal and power connectors (AWG710)	2-6
Figure 2-6: Rear panel signal and power connectors (AWG710B)	2-7
Figure 2-7: Menu buttons, bezel menu buttons, and the CLEAR MENU button	2-8
Figure 2-8: Bottom and side menus	2-9
Figure 2-9: Pop-up menu example	2-10
Figure 2-10: Dialog box example	2-11
Figure 2-11: Knob icon displayed in Status Display area	2-12
Figure 2-12: Keypad buttons	2-13
Figure 2-13: Three type of Input text dialog boxes	2-14
Figure 2-14: Shortcut controls	2-15
Figure 2-15: Files and directories with read only attribute	2-21
Figure 2-16: Input Filename dialog box	2-21
Figure 2-17: File list window examples in which Quick View is available	2-24
Figure 2-18: Viewing a file by Quick View function	2-25
Figure 2-19: Main Edit screen	2-27
Figure 2-20: Edit top level menu screen with Edit side menu	2-28
Figure 2-21: Editor screen elements	2-29
Figure 2-22: Cursors and edit area	2-30
Figure 2-23: Multiple editor windows	2-31
Figure 2-24: Main Setup screen (except option02)	2-34
Figure 2-25: Select File dialog on the Load menu	2-36
Figure 2-26: Viewing a file in the Setup screen	2-37
Figure 2-27: AWG710 block diagram	2-43
Figure 2-28: AWG710B block diagram	2-44
Figure 2-29: Relationship between memory address control and waveform memory	2-45
Figure 2-30: Cable connection between AWG710&AWG710B Arbitrary Waveform Generator and digital storage oscilloscope	2-50
Figure 2-31: Initial screen (Right Figure: option02)	2-50
Figure 2-32: System utility screen	2-51
Figure 2-33: The Select File list	2-54
Figure 2-34: Viewing a waveform loaded into memory	2-55
Figure 2-35: Waveform editor initial screen	2-57
Figure 2-36: The Standard Function dialog box	2-58
Figure 2-37: Standard sine wave function created in the Waveform Editor	2-59
Figure 2-38: Waveform created with the multiply operation	2-60
Figure 2-39: File Name Input dialog box	2-61
Figure 2-40: Waveform in the waveform editor	2-64
Figure 2-41: Waveform edit in quick editor	2-65
Figure 2-42: Viewer displaying compiled waveform	2-69

Figure 2-43: Waveforms created at the same time in three windows	2-72
Figure 2-44: Initial sequence table	2-73
Figure 2-45: Example of sequence (SUBSEQ.seq)	2-75
Figure 2-46: Screen for setting jump mode	2-77
Figure 2-47: Screen for setting event jump	2-78
Figure 2-48: Setup of Goto <N>	2-79
Figure 2-49: Example of sequence (MAINSEQ.seq)	2-80
Figure 3-1: Overview of AWG710&AWG710B Arbitrary Waveform Generator process flow	3-1
Figure 3-2: Setup main screen (except option 02)	3-33
Figure 3-3: 1/4 CLOCK OUT output format	3-41
Figure 3-4: 1/4 CLOCK OUT connection examples	3-42
Figure 3-5: Run mode and current status	3-44
Figure 3-6: Trigger slope and trigger level	3-47
Figure 3-7: Waveform output sequence example	3-51
Figure 3-8: Waveform editor initial screen	3-55
Figure 3-9: Standard Function Waveform dialog box	3-60
Figure 3-10: Register value and tap setting example	3-66
Figure 3-11: Shift Register Generator dialog box	3-67
Figure 3-12: Set Pattern dialog box	3-68
Figure 3-13: Waveform compare operation example	3-75
Figure 3-14: Digital Filter dialog box	3-78
Figure 3-15: XY View dialog box	3-80
Figure 3-16: Settings dialog box	3-83
Figure 3-17: Pattern editor initial screen	3-86
Figure 3-18: Code Convert dialog box and side menu	3-88
Figure 3-19: Code conversion table	3-89
Figure 3-20: Operating data bits (scope)	3-92
Figure 3-21: Area cursors	3-94
Figure 3-22: Counter dialog box	3-95
Figure 3-23: Set Pattern dialog box	3-96
Figure 3-24: A waveform example under quick editing	3-100
Figure 3-25: Controls for quick editing	3-101
Figure 3-26: Table Editor window	3-106
Figure 3-27: Equation editor window	3-110
Figure 3-28: Text selection (example)	3-113
Figure 3-29: File list listing two waveforms created	3-116
Figure 3-30: Sequence editor initial screen	3-117
Figure 3-31: EVENT IN connector	3-124
Figure 3-32: Event signal timing and strobe	3-127
Figure 3-33: Compiling and storing sequences and subsequences	3-129
Figure 3-34: Outline flow for producing HDD reading test signal	3-131
Figure 3-35: Disk application initial screen	3-132
Figure 3-36: Writer Data menu	3-132
Figure 3-37: Isolated Pulse menu	3-133
Figure 3-38: Execution of superpose	3-133
Figure 3-39: Outline flow for producing network test read signal	3-140
Figure 3-40: Network application initial screen	3-140
Figure 3-41: Side menu will change after selecting a standard	3-141
Figure 3-42: Side menu for selecting the Isolated pulse	3-142
Figure 3-43: Execution of superposing	3-143

Figure 3-44: Outline flow for Jitter waveform creation	3-147
Figure 3-45: Jitter composer application initial screen	3-148
Figure 3-46: Input Data menu	3-148
Figure 3-47: A pre-defined pattern was selected as an input data	3-149
Figure 3-48: Jitter profile menu	3-149
Figure 3-49: Execution of jitter composer	3-150
Figure 3-50: Jitter parameters and jitter waveform	3-153
Figure 3-51: GPIB setup screen menu	3-161
Figure 3-52: Network setup screen menu	3-163
Figure 3-53: Message box to indicate the establishment of communication ..	3-165
Figure 3-54: Network Status screen	3-165
Figure 3-55: UTILITY screen mounting remote file system	3-166
Figure 3-56: Drive selections in EDIT menu	3-168
Figure 3-57: Hardcopy setup screen	3-171
Figure 3-58: Hardcopy complete message box	3-172
Figure 3-59: Calibration and diagnostic screen	3-173
Figure 3-60: Status message box (except option02)	3-174
Figure 3-61: Source instrument selection dialog box	3-182
Figure 3-62: Source instrument selection under Others... ..	3-183
Figure 3-63: Waveforms generated from the Example 1 equation	3-208
Figure 3-64: Waveform generated by the Example 2 equation	3-209
Figure 3-65: Waveforms generated by the Example 3 equation	3-210
Figure 3-66: Sequence generated by the Example 3 equation	3-211
Figure 3-67: Source waveform and those generated by the Example 4 equation	3-212
Figure 3-68: Noise waveforms after filtering	3-213
Figure 3-69: Noise waveforms before (upper) and after (lower) 7-point smoothing	3-215
Figure 3-70: Gaussian noise and ramp waveforms	3-217
Figure 3-71: Screen and side menu buttons for importing and exporting ...	3-222
Figure 3-72: Select the conversion type dialog box	3-222
Figure 3-73: Double Windows	3-230
Figure 3-74: Overwrite confirmation	3-232
Figure 3-75: Outline flow for producing Function Generator signal	3-233
Figure 3-76: FG mode screen (except option 02)	3-233
Figure 3-77: Change the generator mode (except option 02)	3-234
Figure 3-78: Waveform type	3-235
Figure 3-79: Output parameters (except option 02)	3-236
Figure 3-80: Marker pattern	3-238
Figure 3-81: Pulse sub-side menu (except option 02)	3-240
Figure 3-82: Outline flow for producing Mixed signal	3-241
Figure 3-83: Waveform Mixing mode screen	3-241
Figure 3-84: Change the generator mode	3-242
Figure 3-85: Outline flow for producing Synchronous operation	3-249
Figure 3-86: Synchronous Operation cable connection	3-251
Figure 3-87: Change the generator mode	3-252
Figure 3-88: Synchronous Operation mode screen	3-253
Figure A-1: Signal Timing	A-9
Figure A-2: Gated Mode	A-10
Figure A-3: Enhanced mode	A-11
Figure A-4: Sequence 2	A-12

Figure A-5: Sequence 3	A-13
Figure A-6: 3-1. Sequence 4	A-14
Figure A-7: The cable connection between units in Synchronous operation ..	A-15
Figure A-8: Output Voltage Window (into 50W to GND) of MARKER	A-16
Figure A-9: Output part equivalent circuit of MARKE	A-17
Figure A-10: Dimensions	A-24
Figure A-11: Signal Timing	A-34
Figure A-12: Dimensions	A-39
Figure B-1: Diagnostic menu	B-3
Figure B-2: Calibration result message box (except option 02)	B-5
Figure B-3: EVENT IN connector pins and signals and ground closure connector	B-9
Figure B-4: Loading file; selecting storage drive	B-9
Figure B-5: Cont mode initial test hookup	B-13
Figure B-6: Triggered mode initial test hookup	B-15
Figure B-7: Relationship between trigger signal and waveform output	B-16
Figure B-8: Relationship between gate signal and waveform output	B-18
Figure B-9: Amplitude accuracy initial test hookup	B-19
Figure B-10: Direct DA output amplitude accuracy initial test hookup	B-23
Figure B-11: Direct DA output pulse rise time initial test hookup	B-25
Figure B-12: Option02 output amplitude accuracy initial test hookup	B-27
Figure B-13: Optipn02 output pulse rise time initial test hookup	B-29
Figure B-14: Pulse response initial test hookup	B-31
Figure B-15: Trigger input initial test hookup	B-33
Figure B-16: Trigger signal and waveform output (+5 V check 1)	B-35
Figure B-17: Trigger signal and waveform output (+5 V check 2)	B-35
Figure B-18: Trigger signal and waveform output (-5 V check 1)	B-36
Figure B-19: Trigger signal and waveform output (-5 V check 2)	B-36
Figure B-20: Event input and enhanced mode initial test hookup	B-37
Figure B-21: Waveform while all ground disclosure switches are open	B-39
Figure B-22: Waveform output when the SW1 is closed	B-39
Figure B-23: Waveform output when SW2 is closed	B-40
Figure B-24: Waveform output when the SW3 is closed	B-40
Figure B-25: Waveform output when SW4 is closed	B-41
Figure B-26: Waveform output when SW6 is closed	B-42
Figure B-27: Waveform output when SW7 is closed	B-42
Figure B-28: Waveform output when SW8 is closed	B-43
Figure B-29: Initial waveform output	B-44
Figure B-30: DC waveform output when the SW5 is closed	B-44
Figure B-31: Trigger input initial test hookup	B-46
Figure B-32: VCO OUT outputfrequency and 10 MHz reference input initial test hookup	B-48
Figure B-33: Marker output initial test hookup	B-50
Figure B-34: Synchronous operation test hookup	B-52
Figure B-35: Diagnostic menu	B-57
Figure B-36: Calibration result message box (except option 02)	B-59
Figure B-37: EVENT IN connector pins and signals and ground closure connector	B-62
Figure B-38: Loading file; selecting storage drive	B-63
Figure B-39: Cont mode initial test hookup	B-66
Figure B-40: Triggered mode initial test hookup	B-68

Figure B-41: Relationship between trigger signal and waveform output	B-69
Figure B-42: Relationship between gate signal and waveform output	B-71
Figure B-43: Amplitude accuracy initial test hookup	B-73
Figure B-44: Direct DA output amplitude accuracy initial test hookup	B-77
Figure B-45: Direct DA output pulse rise time initial test hookup	B-79
Figure B-46: Option02 output amplitude accuracy initial test hookup	B-81
Figure B-47: Optipn02 output pulse rise time initial test hookup	B-83
Figure B-48: Pulse response initial test hookup	B-85
Figure B-49: Trigger input initial test hookup	B-87
Figure B-50: Trigger signal and waveform output (+5 V check 1)	B-89
Figure B-51: Trigger signal and waveform output (+5 V check 2)	B-89
Figure B-52: Trigger signal and waveform output (-5 V check 1)	B-90
Figure B-53: Trigger signal and waveform output (-5 V check 2)	B-90
Figure B-54: Event input and enhanced mode initial test hookup	B-91
Figure B-55: Waveform while all ground disclosure switches are open	B-93
Figure B-56: Waveform output when the SW1 is closed	B-93
Figure B-57: Waveform output when SW2 is closed	B-94
Figure B-58: Waveform output when the SW3 is closed	B-95
Figure B-59: Waveform output when SW4 is closed	B-95
Figure B-60: Initial waveform output	B-96
Figure B-61: DC waveform output when the SW5 is closed	B-97
Figure B-62: 1/4 Clock frequency and 10 MHz reference input initial test hookup	B-98
Figure B-63: Marker output initial test hookup	B-100
Figure E-1: File transfer interface outline	E-1
Figure F-1: Equation differentiation	F-2
Figure F-2: Equation integration	F-3
Figure F-3: Conversion image example	F-7

List of Tables

Table 1-1: AWG710&AWG710B waveform editors	1-2
Table 1-2: Power cord options	1-5
Table 1-3: Language options	1-5
Table 1-4: Standard accessories	1-6
Table 1-5: Optional accessories	1-6
Table 1-6: Fuse and fuse cap part numbers	1-11
Table 1-7: Power cord identification	1-12
Table 2-1: Side menu elements	2-10
Table 2-2: Text input button functions	2-15
Table 2-3: Shortcut controls	2-16
Table 2-4: AWG710&AWG710B Arbitrary Waveform Generator file types ..	2-17
Table 2-5: Drive and Directory menus	2-18
Table 2-6: Waveform record length adjustment messages	2-22
Table 2-7: Editors	2-26
Table 2-8: Edit screen bottom menu buttons	2-27
Table 2-9: Edit side menu buttons	2-29
Table 2-10: Setup screen parameter icons	2-35
Table 2-11: Setup bottom menu buttons	2-35
Table 2-12: Setup output parameter operations	2-38
Table 2-13: Run modes	2-41
Table 2-14: Extended operation	2-42
Table 2-15: Editors	2-47
Table 2-16: Waveforms to be used in sample sequences	2-71
Table 2-17: Sequence table contents in SUBSEQ.seq	2-74
Table 2-18: Sequence table contents in MAINSEQ.seq	2-76
Table 3-1: AWG710&AWG710B Arbitrary Waveform Generator main menus	3-2
Table 3-2: Waveform parameter icons	3-34
Table 3-3: Setup bottom menu buttons	3-34
Table 3-4: Status area	3-35
Table 3-5: Clock signal output timing	3-41
Table 3-6: External trigger signal requirements	3-46
Table 3-7: Instrument run state and state messages	3-53
Table 3-8: Waveform editor screen elements	3-56
Table 3-9: Waveform editor bottom menu	3-57
Table 3-10: Standard Function Waveform dialog box parameters	3-60
Table 3-11: Shift Register Generator dialog box setting parameters	3-67
Table 3-12: Set Pattern dialog box parameters	3-69
Table 3-13: Mathematical function commands	3-72
Table 3-14: Compare dialog box parameters	3-75
Table 3-15: Convolution dialog box parameters	3-76
Table 3-16: Correlation dialog box parameters	3-77
Table 3-17: Digital filter dialog box parameters	3-78
Table 3-18: Re-sampling dialog box parameters	3-79
Table 3-19: XY View dialog box parameters	3-80
Table 3-20: Zoom/Pan side menu buttons	3-81
Table 3-21: Setup window parameters	3-83

Table 3-22: Setup general parameters	3-84
Table 3-23: Pattern editor screen elements	3-86
Table 3-24: Pattern editor bottom menu	3-87
Table 3-25: Code conversion commands	3-89
Table 3-26: Code conversion parameters	3-89
Table 3-27: Patterns to be selected in Counter dialog box	3-95
Table 3-28: Set Pattern dialog box parameters	3-97
Table 3-29: Equation editor screen elements	3-110
Table 3-30: Equation editor bottom menu	3-111
Table 3-31: Front-panel Equation editor controls	3-112
Table 3-32: Control keys from the external keyboard	3-114
Table 3-33: Sequence table columns	3-118
Table 3-34: Sequence editor bottom menu	3-119
Table 3-35: Pre-defined patterns	3-134
Table 3-36: Code Conversion	3-134
Table 3-37: Superpose parameters	3-138
Table 3-38: Pre-defined patterns	3-144
Table 3-39: Code conversion	3-144
Table 3-40: Network parameters	3-145
Table 3-41: Pre-defined patterns	3-151
Table 3-42: Jitter composer parameters	3-152
Table 3-43: External keyboard edit operations	3-156
Table 3-44: Available FTP commands	3-169
Table 3-45: Diagnostic categories and error codes	3-176
Table 3-46: BNF symbols and meanings	3-185
Table 3-47: Programming language math functions	3-200
Table 3-48: Math operators	3-202
Table 3-49: Predefined variables	3-205
Table 3-50: File utility commands	3-225
Table 3-51: Special symbols used for expressing file path	3-226
Table 3-52: File operation in double windows	3-231
Table 3-53: Confirmation selection for copy-all and move-all operations ...	3-232
Table 3-54: Output frequency and filter cut-off frequency (except option02)	3-237
Table 3-55: Predefined Marker signal	3-238
Table 3-56: Output Frequency and Waveform Length	3-239
Table 3-57: Combination of the file type	3-243
Table 3-58: Difference between AWG mode and synchronous operation mode	3-254
Table 3-59: Error/Warning messages	3-255
Table A-1: Operation modes	A-2
Table A-2: Extended Operation	A-2
Table A-3: Arbitrary waveforms	A-2
Table A-4: Clock generator	A-3
Table A-5: Internal trigger generator	A-3
Table A-6: Main output	A-3
Table A-7: Filter (except option 02)	A-5
Table A-8: Auxiliary outputs	A-5
Table A-9: Marker output Period Jitter	A-7
Table A-10: Marker output Cycle to Cycle Jitter	A-7
Table A-11: VCO output Period Jitter	A-7
Table A-12: VCO output Cycle to Cycle Jitter	A-7

Table A-13: Auxiliary inputs	A-8
Table A-14: Event Input	A-18
Table A-15: 10 MHz reference clock input	A-18
Table A-16: External clock input	A-18
Table A-17: C input	A-19
Table A-18: T input	A-19
Table A-19: Function Generator (FG)	A-20
Table A-20: Display	A-21
Table A-21: AC line power	A-21
Table A-22: Timer	A-21
Table A-23: Interface connectors	A-21
Table A-24: Installation requirement	A-22
Table A-25: Maintenance requirement	A-22
Table A-26: Environmental	A-22
Table A-27: Mechanical	A-23
Table A-28: Certifications and compliances	A-25
Table A-29: Installation category and Pollution degree Descriptions	A-26
Table A-30: Operation modes	A-28
Table A-31: Arbitrary waveforms	A-28
Table A-32: Clock generator	A-29
Table A-33: Internal trigger generator	A-29
Table A-34: Main output	A-29
Table A-35: Filter (except option 02)	A-31
Table A-36: Auxiliary outputs	A-31
Table A-37: Period Jitter	A-32
Table A-38: Cycle to Cycle Jitter	A-32
Table A-39: Auxiliary inputs	A-33
Table A-40: Event Input	A-35
Table A-41: 10 MHz reference clock input	A-35
Table A-42: Function Generator (FG)	A-36
Table A-43: Display	A-37
Table A-44: AC line power	A-37
Table A-45: Timer	A-37
Table A-46: Interface connectors	A-37
Table A-47: Installation requirement	A-38
Table A-48: Environmental	A-38
Table A-49: Mechanical	A-39
Table A-50: Certifications and compliances	A-40
Table A-51: Installation category and Pollution degree Descriptions	A-41
Table B-1: Performance test items	B-6
Table B-2: Test equipment	B-7
Table B-3: Waveforms and sequences in performance check disk	B-11
Table B-4: Performance test items	B-60
Table B-5: Test equipment	B-61
Table B-6: Waveforms and sequences in performance check disk	B-64
Table C-1: External inspection check list	C-1
Table D-1: Waveform and equation files in the sample disk	D-1
Table D-2: Gaussian pulse	D-2
Table D-3: Lorentz pulse	D-3
Table D-4: Sampling function SIN(X)/X pulse	D-3
Table D-5: Squared sine pulse	D-4

Table D-6: Double exponential pulse	D-4
Table D-7: Nyquist pulse	D-5
Table D-8: Linear frequency sweep	D-6
Table D-9: Log frequency sweep	D-6
Table D-10: Amplitude modulation	D-7
Table D-11: Frequency modulation	D-7
Table D-12: Pulse width modulation	D-8
Table D-13: Pseudo-random pulse	D-8
Table D-14: Waveform for magnetic disk signal	D-8
Table D-15: Isolated pulse for disk application	D-9
Table D-16: Isolated pulse for disk application	D-9
Table D-17: Isolated pulse for disk application	D-10
Table D-18: Isolated pulse for network application	D-10
Table D-19: Isolated pulse for network application	D-11
Table D-20: Isolated pulse for network application	D-11
Table D-21: Isolated pulse for network application	D-11
Table D-22: Isolated pulse for network application	D-12
Table D-23: Isolated pulse for network application	D-12

General Safety Summary

Review the following safety precautions to avoid injury and prevent damage to this product or any products connected to it. To avoid potential hazards, use this product only as specified.

Only qualified personnel should perform service procedures.

To Avoid Fire or Personal Injury

Use Proper Power Cord. Use only the power cord specified for this product and certified for the country of use.

Ground the Product. This product is grounded through the grounding conductor of the power cord. To avoid electric shock, the grounding conductor must be connected to earth ground. Before making connections to the input or output terminals of the product, ensure that the product is properly grounded.

Observe All Terminal Ratings. To avoid fire or shock hazard, observe all ratings and markings on the product. Consult the product manual for further ratings information before making connections to the product.

The common terminal is at ground potential. Do not connect the common terminal to elevated voltages.

Do not apply a potential to any terminal, including the common terminal, that exceeds the maximum rating of that terminal.

Do Not Operate Without Covers. Do not operate this product with covers or panels removed.

Use Proper Fuse. Use only the fuse type and rating specified for this product.

Avoid Exposed Circuitry. Do not touch exposed connections and components when power is present.

Do Not Operate With Suspected Failures. If you suspect there is damage to this product, have it inspected by qualified service personnel.

Do Not Operate in Wet/Damp Conditions.

Do Not Operate in an Explosive Atmosphere.

Keep Product Surfaces Clean and Dry.

Provide Proper Ventilation. Refer to the manual's installation instructions for details on installing the product so it has proper ventilation.

Symbols and Terms **Terms in this Manual.** These terms may appear in this manual:



WARNING. *Warning statements identify conditions or practices that could result in injury or loss of life.*



CAUTION. *Caution statements identify conditions or practices that could result in damage to this product or other property.*

Terms on the Product. These terms may appear on the product:

DANGER indicates an injury hazard immediately accessible as you read the marking.

WARNING indicates an injury hazard not immediately accessible as you read the marking.

CAUTION indicates a hazard to property including the product.

Symbols on the Product. The following symbols may appear on the product:



WARNING
High Voltage



Protective Ground
(Earth) Terminal



CAUTION
Refer to Manual



Double
Insulated

Preface

This manual provides user information for the AWG710&AWG710B Arbitrary Waveform Generator.

Manual Structure

The AWG710&AWG710B Arbitrary Waveform Generator User Manual contains the following sections:

The *Getting Started* section covers initial instrument inspection, available options and accessories, instrument installation procedures, and power on and off procedures. In particular, the installation section covers the procedures required prior to turning on the unit and areas of the instrument that require special care or caution.

The *Operating Basics* section describes instrument controls and menus, introduces instrument-specific terminology, provides an overview of the instrument internal structure, operating principles, basic operating procedures, and numeric input methods. This section also provides basic signal editing examples.

The *Reference* section describes the functions and menu operations.

The *Appendices* provide product specifications, performance verification procedures, sample waveforms, file transfer, outline sequence file text format, inspection and cleaning instructions.

Conventions

This manual uses the following conventions:

- Front-panel button and control labels are printed in the manual in upper case text. For example, **SETUP**, **SHIFT**, **APPL**. If it is part of a procedure, the button or control label is printed in boldface. For example, Select **SETUP**.
- Menu and on-screen form titles are printed in the manual in the same case (initial capitals or all uppercase) as they appear on the instrument screen (for example, **Offset Vertical**). If it is part of a procedure, the menu title is shown in boldface (for example, 'Select the **Vertical** menu').
- A list of buttons, controls, and/or menu items separated by an arrow symbol (→) indicates the order in which to perform the listed tasks. For example:

Select **SETUP** (front)→**Vertical** (bottom)→**Offset** (side)→**10MHz** (knob).

The text in parenthesis indicates the type of button, knob, menu, or form item to select or modify, as described in the following table.

Type	Description
front	Push the indicated front-panel button
bottom	Push the indicated bottom-menu button
side	Push the indicated side-menu button
knob	Turn the indicated front-panel control knob (usually the general purpose knob)
pop-up	Make selections or change values in the indicated pop-up menu
dialog	Make selections or change values in the indicated dialog box
screen	Make selections or change values on the indicated instrument screen

Related Manuals

Following are additional manuals that are available for the AWG710&AWG710B Arbitrary Waveform Generator:

- The *AWG710&AWG710B Arbitrary Waveform Generator Programmer Manual* provides complete information on programming and remote control of the instrument through the GPIB/Ethernet interfaces. This manual is a standard accessory.
- The *AWG710&AWG710B Arbitrary Waveform Generator Service Manual* describes how to maintain and service the AWG710&AWG710B Arbitrary Waveform Generator and provides a complete module-level description of the instrument operation. This manual is an optional accessory.

Contacting Tektronix

Phone	1-800-833-9200*
Address	Tektronix, Inc. Department or name (if known) 14200 SW Karl Braun Drive P.O. Box 500 Beaverton, OR 97077-0001 USA
Web site	www.tektronix.com
Sales support	1-800-833-9200, select option 1*
Service support	1-800-833-9200, select option 2*
Technical support	Email: support@tektronix.com 1-800-833-9200, select option 3* 1-503-627-2400 6:00 a.m. - 5:00 p.m. Pacific time

* **This phone number is toll free in North America. After office hours, please leave a voice mail message.**

Outside North America, contact a Tektronix sales office or distributor; see the Tektronix web site for a list of offices.



Getting Started

Getting Started

This section provides the following information:

- Description and features of the AWG710&AWG710B Arbitrary Waveform Generator
- Initial inspection procedure
- Standard and optional accessories listings
- Installation procedures
- Power on and off procedures
- Repackaging procedure for shipment

Product Description

The AWG710&AWG710B Arbitrary Waveform Generator is a waveform generator that can generate simple and arbitrary waveforms and generates one-channel differential output arbitrary waveforms and function generator waveforms.

The AWG710&AWG710B Arbitrary Waveform Generator allows you to create sine, triangle, square, ramp, and complex waves, as well as direct current and noises signals. It allows you to set waveform attributes, such as frequency, amplitude, and offset.

This instrument contains a hard disk drive, a 3.5-inch floppy disk drive, and Ethernet interface for storing and recalling waveform data and instrument settings.

You can remotely control the instrument by sending commands through both the GPIB and 100/10BASE-T interfaces, as well as transfer waveform data directly from a digital storage oscilloscope to the AWG710&AWG710B Arbitrary Waveform Generator using the GPIB interface. This enables you to use the instrument in combination with other measurement equipment and a computer.

Main Features

The AWG710&AWG710B Arbitrary Waveform Generator contains the following main features:

- 4.2 GS/s Sampling Rate: AWG710B
4.0 GS/s Sampling Rate: AWG710
- 8-bit DA converter

- 32.4 M-word waveform memory (62.8 M optional):AWG710B
16.2 M-word waveform memory (32.4 M optional): AWG710
- Two arbitrary marker outputs
- Five waveform editors (see Table 1-1)

Table 1-1: AWG710&AWG710B waveform editors

Editor	Description
Waveform	Creates analog waveform data in graphic or tabular form.
Pattern	Creates analog waveform data in timing and table form.
Sequence	Creates sequences of waveforms by combining the waveform files created with the Waveform and/or Pattern Editors.
Text	Edits plain ASCII-format waveform files. For example, you can use the Text editor to edit ASCII-format waveform files that are read from an external device.
Equation	Creates files with equations and compiles them into waveform files.

- FG mode to generate a standard functional waveform easily
- Waveform Mixing mode to generate a mixing two-signals digitally.
- Synchronous operation mode to generate 2 channel signals by two AWG710Bs. (AWG710B only)

Additional Features

The AWG710&AWG710B Arbitrary Waveform Generator provides the following additional features:

- An Ethernet port for using the NFS (Network File System) and/or FTP link. Refer to *Ethernet Networking* on page 3-162 for information.
- A GPIB interface that can be used for remotely controlling the AWG710&AWG710B Arbitrary Waveform Generator and for transferring the waveform data from the external oscilloscopes.

Refer to *Connecting to a GPIB Network* on page 3-160 for information on setting the GPIB parameters.

Refer to the *AAWG710&AWG710B Arbitrary Waveform Generator Programmer Manual* for information on the remote control commands.

Refer to *Capturing Waveforms* on page 3-181 for information about transferring waveforms from the external oscilloscopes to the AWG710&AWG710B Arbitrary Waveform Generator.

- A port on the rear panel for connecting a 101- or 106- type keyboard to the AWG710&AWG710B Arbitrary Waveform Generator. You can input values or text with the keyboard instead of using the numeric keypad on the front-panel. Refer to *External Keyboards* on page 3-155 for information.

- An adjustment of focused color. Refer to *Focused Color* on page 3-158 for information. This setup procedure is also described in *Tutorial 1: Instrument Setup* on page 2-51.

Incoming Inspection

Inspect the AWG710&AWG710B Arbitrary Waveform Generator carton for external damage. If the carton is damaged, notify the carrier.

Remove the AWG710&AWG710B Arbitrary Waveform Generator from its carton and check that the instrument has not been damaged in transit. Verify that the carton contains the basic instruments and its standard accessories. Refer to *Standard Accessories* on page 1-6.

This instrument was thoroughly inspected for mechanical and electrical defects before shipment. It should be free of dents or scratches. To confirm this, inspect the instrument for physical damage that occurred in transit, and test the instrument functionality by following the *Tutorials* beginning on page 2-49. You can also verify the performance of the instrument by following the procedures in *Appendix Appendix B: Performance Verification* beginning on page B-55. If a discrepancy is found, contact your local Tektronix Field Office or representative.

NOTE. *Save the shipping carton and packaging materials for repackaging in case shipment becomes necessary.*

Power Cord Options

Table 1-2 lists the power cords available with the AWG710&AWG710B Arbitrary Waveform Generator.

Table 1-2: Power cord options

Option	Description	Tektronix part number
Standard	US Power Cord, 115 V	161-0104-00
A1	Europe, 220 V	161-0104-06
A2	United Kingdom, 240 V	161-0104-07
A3	Australia, 240 V	161-0104-05
A5	Switzerland, 220 V	161-0167-00
A6	Japan, 100 V	161-A005-00
A10	China, 240 V	161-0306-00
A99	No power cord	-----

Language Options

The following two language options are provided for the AWG710&AWG710B Arbitrary Waveform Generator.

Table 1-3: Language options

Option	Description	Part number
L0	English manuals	
	User manual	071-1413-xx
	Programmer manual	071-1414-xx
	Registration card	001-1121-01
L5	Japanese manuals	
	User manual	071-1415-xx
	Programmer manual	071-1416-xx
	Registration card	000-A058-00

Accessories

Standard Accessories The AWG710&AWG710B Arbitrary Waveform Generator includes the standard accessories listed in Table 1-4:

Table 1-4: Standard accessories

Accessory	Part number
User Manual	See Table 1-3 for part number
Programmer Manual	
Sample waveform floppy disk, 3.5 inch for AWG710B for AWG710	063-3740-xx 062-A271-xx
Sample program floppy disk, 3.5 inch	062-A258-xx
Performance check/adjustment floppy disk, 3.5 inch for AWG710B for AWG710	063-3721-xx 062-A273-xx
Arb-Link Software (AWG710)	062-A270-xx
ArbExpress Software (AWG710B)	063-3763-xx
ArbExpress Instructions (AWG710B)	061-4288-xx
SMA 50 Ω terminator, Male (2 installed on the instrument)	015-1022-01
Power Cord (except A99)	(see Table 1-2)

Optional Accessories The following optional accessories, listed in Table 1-5, are recommended for use with the instrument:

Table 1-5: Optional accessories

Accessory	Part number
Service Manual	071-1417-xx
Front cover	200-3696-01
Rack Mount Kit (for field conversion)	020-2556-00
GPIB cable	012-0991-00
BNC cable, 50 Ω , 0.6 m (2 ft)	012-1342-00
BNC cable, 50 Ω , 2.5 m (8.2 ft), double-shield	012-1256-00
BNC terminator, 50 Ω	011-0049-02
BNC power divider, 50 Ω , DC to 300 MHz, VSWR: 1.2 max.	015-0660-00
SMA cable, 50 Ω , 0.5 m, (1.64 ft), Male-Male	174-1427-00
SMA cable, 50 Ω , 1.0 m, (3.28 ft), Male-Male	174-1341-00
SMA cable, 50 Ω , 1.5 m, (4.92 ft), Male-Male	174-1428-00
SMA precision delay cable, 1 ns, Male-Male	015-0562-00
SMA precision delay cable, 2 ns, Male-Male	015-0560-00

Table 1-5: Optional accessories (cont.)

Accessory	Part number
SMA precision delay cable, 5 ns, Male–Male	015–0561–00
SMA T–connector, Male–Female & Female	015–1016–00
SMA 50 Ω divider, Male	015–1014–00
SMA–BNC adapter, Male–Female	015–0554–00
SMA–BNC adapter, Female–Male	015–0572–00
SMA adapter kit	020–1693–00
BNC low pass filter, 400 MHz	015–0659–00
BNC low pass filter, 200 MHz	015–0658–00
BNC low pass filter, 100 MHz	015–0657–00
SMA delay cable, 1 ns, Male–Male	015–0562–00
AC Current Probe CT-1	CT1
AC Current Probe CT-2	CT2
AC Current Probe CT-3	CT6
Cart	K475

Options

This subsection describes the following options available with the AWG710&AWG710B Arbitrary Waveform Generator:

- Option 01 (64.8 M Words memory:AWG710B)
Option 01 (32.4 M Words memory:AWG710)
- Option 02 (High Bandwidth output)
- Option 1R (Rack mounting)
- Option 10 (Flash disk, 256 MB)
- Option 11 (Removable Hard Disk: AWG710B)
- Option D1 (Test result report, English)
- Option TDAT (Test result report, Japanese)

Each of these options is discussed in detail in the following paragraphs.

Option 01 (64.8 MB Words Memory)

Increase memory length up to 64.8 M word (64,800,000 points)(AWG710B).
Increase memory length up to 32.4 M word (32,400,000 points)(AWG710).

Option 02 (High Bandwidth Output)

Expand output bandwidth
The product which has option 02 doesn't have offset and lowpass filter function, also, main output amplitude of 20mVp-p to 2Vp-p is changed to 500mVp-p to 1Vp-p into a 50 Ohm load.

Option 1R (Rack Mounting)

AWG710&AWG710B Arbitrary Waveform Generator comes configured for installation in a 19-inch wide instrument rack. For later field conversions, order Rack Mount Kit (020-2556-00) or contact your local Tektronix sales office or representative.

Option D1 (Test Result Report)

A calibration data test result report will be provided with the AWG710&AWG710B Arbitrary Waveform Generator when this option is specified.

Option 10 (Flash Disk)

256 MB Flash disk addition. The hard disk is deleted when this option is ordered. This option allows 24 hour continuous operation. The number of points used in the Waveform Editor is restricted because of the reduced disk space.

The AWG710&AWG710B Arbitrary Waveform Generator retains the state of the front panel ON/STB switch. The ON/STB switch must be left in the on position to be able to power on and power off the instrument using the principal power switch.

NOTE. *If the ON/STB switch is left in the off position, you will not be able to power on/off the instrument using the principal power switch or an external power switch unit*

**Option 11 (Removable
Hard disk)**

This option transposes an internal hard disk to the removable hard disk attached outside. The security and handling of data are improved by using a removable hard disk.

**Option D1,TDAT (Test
Result Report)**

A calibration data test result report will be provided with the AWG710&AWG710B Arbitrary Waveform Generator when this option is specified. D1 is English and TDAT is Japanese.

Installation

Before installation, refer to the *Safety Summary* section at the front of this manual for power source, grounding, and other safety information.

Environment Verify that you have the correct operating environment.



CAUTION. *To prevent damage to the instrument, do not power on the instrument at temperatures outside the specified temperature range.*

The AWG710&AWG710B Arbitrary Waveform Generator operates correctly in ambient temperatures from +10° C to +40° C and relative humidity from 20% to 80%. If the instrument is stored long time at temperatures outside this range, wait for a while and then power on the instrument. For more operating environment information, refer to *Appendix A: Specifications* on page A-1.

NOTE. *If you are installing the instrument in a rack, refer to the instruction sheet that comes with the rack-mounting kit for proper installation procedures.*

Verify that there is nothing blocking the flow of air at the fan and air intake holes. The instrument exhausts air with the fan on its left side. Leave space at the sides of the instrument so that the instrument does not overheat. The following are the minimum space requirements for air flow around the instrument:

Rear	7.5 cm (3 in)
Right and Left	15.0 cm (6 in)
Top and Bottom	2 cm (0.8 in)

(The feet on the bottom of the instrument provide the required clearance when set on a flat surface.)

NOTE. *If the air flow is restricted and the internal temperature of the AWG710&AWG710B Arbitrary Waveform Generator exceeds the proper operating range, the instrument displays a message “Out of temperature limit” and temporarily shuts down to protect the internal modules from overheating. To prevent temporary shutdown of the AWG710&AWG710B Arbitrary Waveform Generator, do not restrict air flow through the chassis.*

If the AWG710&AWG710B Arbitrary Waveform Generator shuts down unexpectedly, improve ventilation around the AWG710&AWG710B Arbitrary Waveform Generator, and wait a few minutes to allow it to cool down; then switch the power on again.

You cannot power on the instrument when the ambient temperature exceeds the operation range. Wait until the instrument cools down, or the ambient temperature decreases to valid operating temperatures, before turning on the instrument again.

Check Fuse Check the fuse that it is the proper type and rating.

Remove the fuse from the fuse holder on the rear panel and check the fuse. To remove the fuse, turn it counterclockwise with a screwdriver while pushing it in. There are two types of fuses provided. Table 1-6 lists the fuse types and ratings.



WARNING. To avoid electrical shock, make sure that the power cord is disconnected from the socket before checking the line fuse.

Table 1-6: Fuse and fuse cap part numbers

Fuse	Fuse part number	Fuse cap part number
0.25 inch × 1.25 inch (UL 198G, 3AG) : 10A FAST, 250 V	159-0407-XX	200-2264-XX
5 mm × 20 mm (IEC 127) : 5A (T), 250 V	159-0210-XX	200-2265-XX

NOTE. The second fuse listed in the table above is approved under the IEC standards. This fuse is used in equipment sold in the European market.

Check Voltage Settings

Check that you have the proper electrical connections. The AWG710&AWG710B Arbitrary Waveform Generator operates within the following power supply voltage and frequency ranges:

Line voltage range	100 - 240 V AC
Line frequency	48 - 63 Hz (100 - 240 V AC)
Maximum power	240 VA (220 VA:AWG710)

Connect Power Cord

Connect the proper power cord from the rear panel power connector to the power system.

Table 1-7: Power cord identification

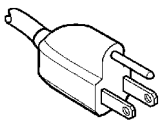
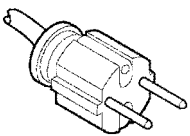
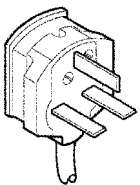
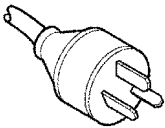
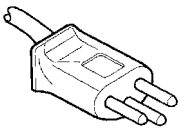
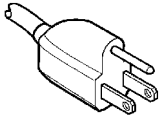
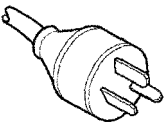
Plug configuration	Normal usage	Option number
	North America	A0
	Europe	A1
	United Kingdom	A2
	Australia	A3
	Switzerland	A5
	Japan	A6
	China	A10

Standby Power

Push the **PRINCIPAL POWER SWITCH** (shown in Figure 1-1) on the rear panel of the instrument. Power is now applied to the instrument standby circuitry. Once the instrument is installed, leave the **PRINCIPAL POWER SWITCH** on and use the **ON/STBY** switch, located on the front-panel, to turn the instrument on and off.

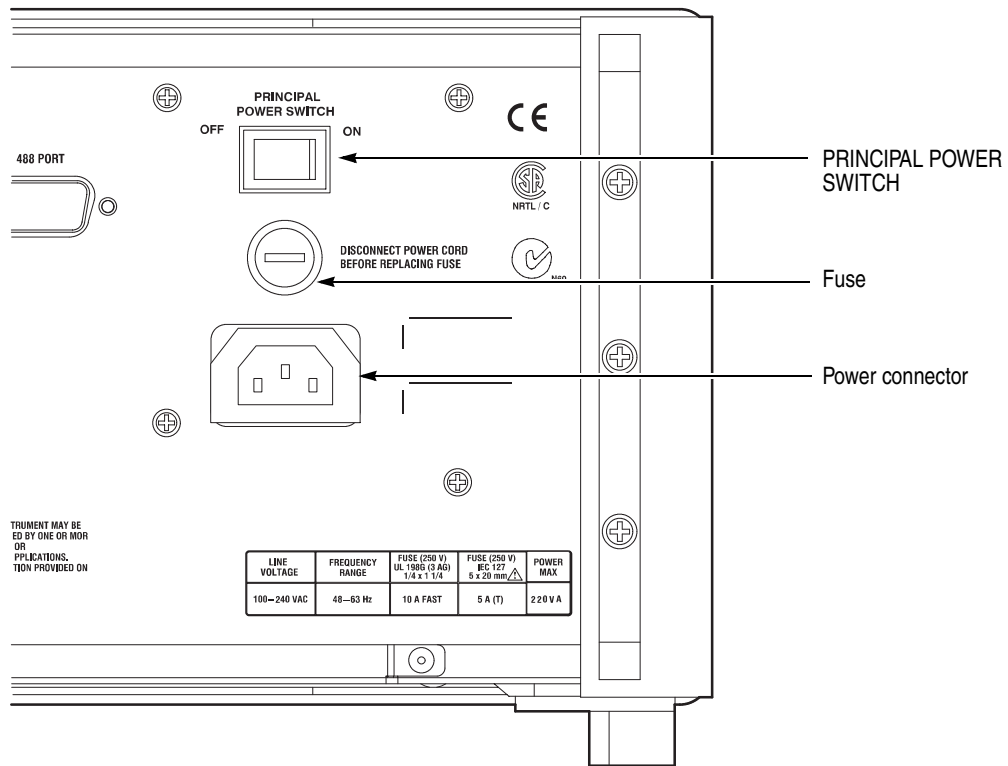

Figure 1-1: Rear panel power switch, fuse holder, and power connector

Power On Push the **ON/STBY** switch (shown in Figure 1-2) on the lower left side of the front panel to power on the instrument. Check that the fan is blowing air out of the instrument.

NOTE. *The instrument needs to be warmed up for at least 20 minutes and the clock calibrated to operate at its optimum accuracy.*

It will take 1 - several minutes to start up after pushing the ON/STBY switch. The starting time depends on the data length of the waveform file loaded when power Off was executed last time.

In addition, AWG cannot start up when floppy disk other than a system disk is inserted in the floppy disk drive. Please power on after ejecting a disk.

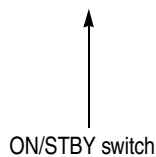

Figure 1-2: Location of the ON/STBY switch

Power-On Diagnostics

The instrument automatically runs power-on self tests to check that the instrument is operating normally.

Check the results of the power-on self tests. If all the diagnostic tests are completed without error, the instrument displays *Pass* and then displays the SETUP menu screen.

If the system detects an error, the instrument displays *Fail* and the error code number on the screen. You can still operate the instrument if you exit this state, but the waveform output accuracy is not guaranteed until the error is corrected. To exit the diagnosis mode, push any button. The system goes to the SETUP menu screen.

NOTE. Contact your local Tektronix Field Office or representative if the instrument displays an error message. Be sure to record the error code number.

Power Off

To power off the AWG710&AWG710B Arbitrary Waveform Generator, push the **ON/STBY** switch on the front panel.



WARNING. To prevent electrical shock, remove all power from the instrument, turn the **PRINCIPAL POWER SWITCH** on the back panel to **OFF**, and disconnect the power cord from the instrument. Some components in the AWG710&AWG710B Arbitrary Waveform Generator are still connected to line voltage after turning off the instrument from the front-panel **ON/STBY** button.



CAUTION. To prevent loss of data and/or damage to the hard drive, before the power off, be sure to confirm the LED of hard drive at the lower right of the front panel does not light or blink.

Repackaging for Shipment

If this instrument is shipped by commercial transportation, use the original packaging material. If the original packaging is unfit for use or is not available, repackage the instrument as follows:

1. Obtain a corrugated cardboard shipping carton having inside dimensions at least 3 inches greater than the instrument dimensions and having a carton test strength of at least 125 kg (275 lb.).
2. If the instrument is being shipped to a Tektronix Service Center for repair or calibration, attach a tag to the instrument showing the following information:
 - The owner of the instrument (with address).
 - The name of a person at your firm who may be contacted if additional information is needed.
 - The complete instrument type and serial number.
 - A description of the service required.
3. Wrap the instrument with polyethylene sheeting or equivalent to protect the outside finish and prevent entry of packing materials into the instrument.
4. Cushion the instrument on all sides by tightly packing dunnage or urethane foam between the carton and the instrument, allowing for 7.62 cm (3 in) of padding on each side (including top and bottom).
5. Seal the carton with shipping tape or with an industrial stapler.
6. Mark the address of the Tektronix Service Center and your return address on the carton in one or more prominent locations.

NOTE. *Do not ship the instrument with a diskette inside the floppy disk drive. When a diskette is inside the drive, the disk release button sticks out. This makes the button susceptible to damage.*



Operating Basics

Operating Basics

This section provides the following information:

- The *Controls and Connectors* subsection describes the instrument buttons, controls, connectors, and typical screen displays.
- The *Menu Operations* subsection describes how to operate menus and enter numeric and text values.
- The *File Management* subsection describes the overview of the instrument commands and operations for file management tasks.
- The *Editor Overview* subsection introduces the waveform editor functions and operations.
- The *Setup Overview* subsection describes the SETUP screen, and simple operations.
- The *Theory of Operation* subsection describes the electrical operation of the AWG710&AWG710B Arbitrary Waveform Generator

Controls and Connectors

Front Panel Figures 2-1, 2-3, and 2-4 show the locations of the front-panel controls and connectors.



CAUTION. *To prevent data corruption, do not push the eject button while the LED is on. Doing so can cause data corruption on the floppy disk and cause the instrument to hang up. If this happens, turn power off then back on again.*

To prevent damage to the instrument, do not apply any external voltage to the output connector or marker connector.

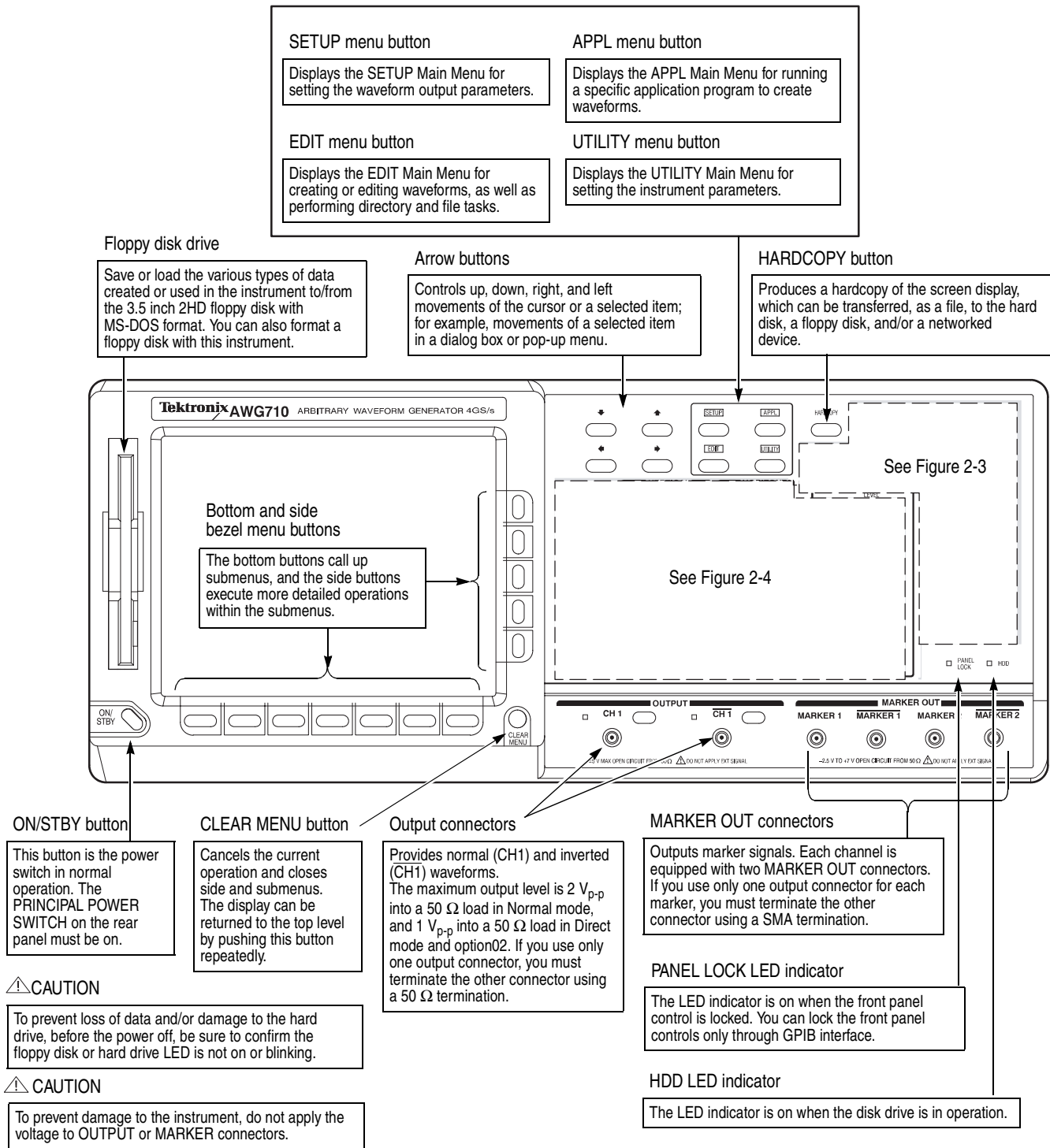

Figure 2-1: Front panel controls (AWG710)

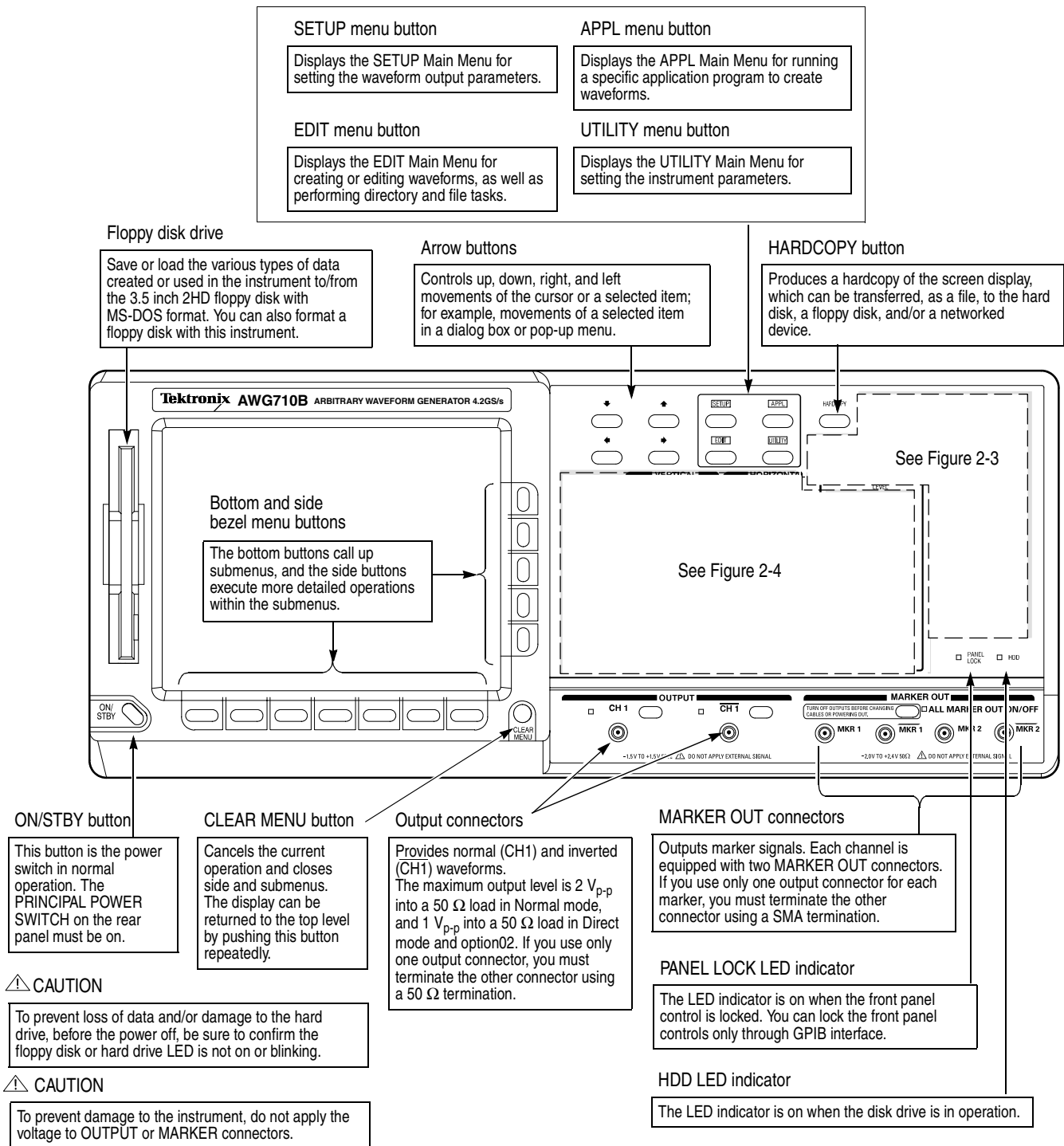

Figure 2-2: Front panel controls (AWG710B)

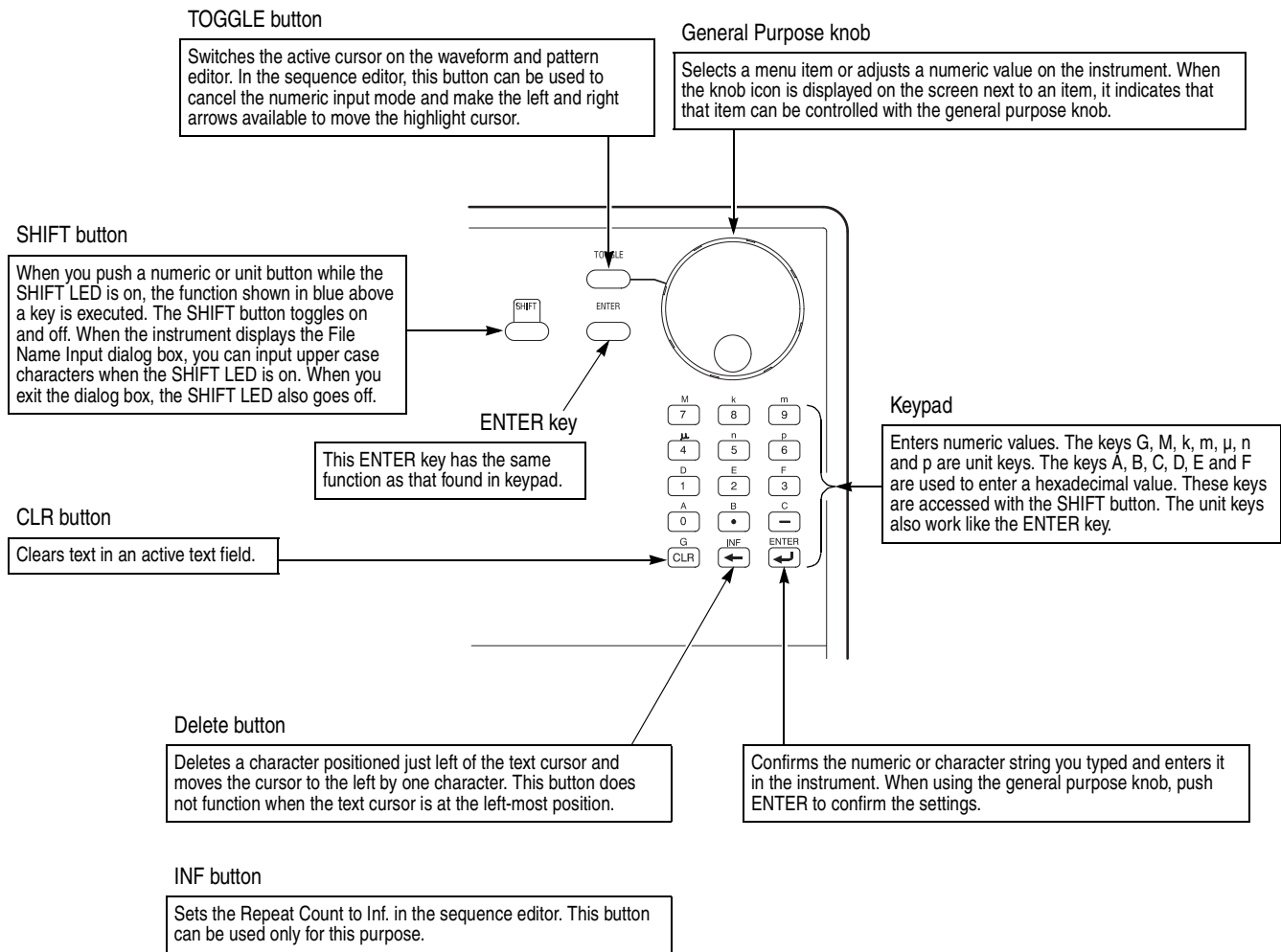

Figure 2-3: Front panel keypad area

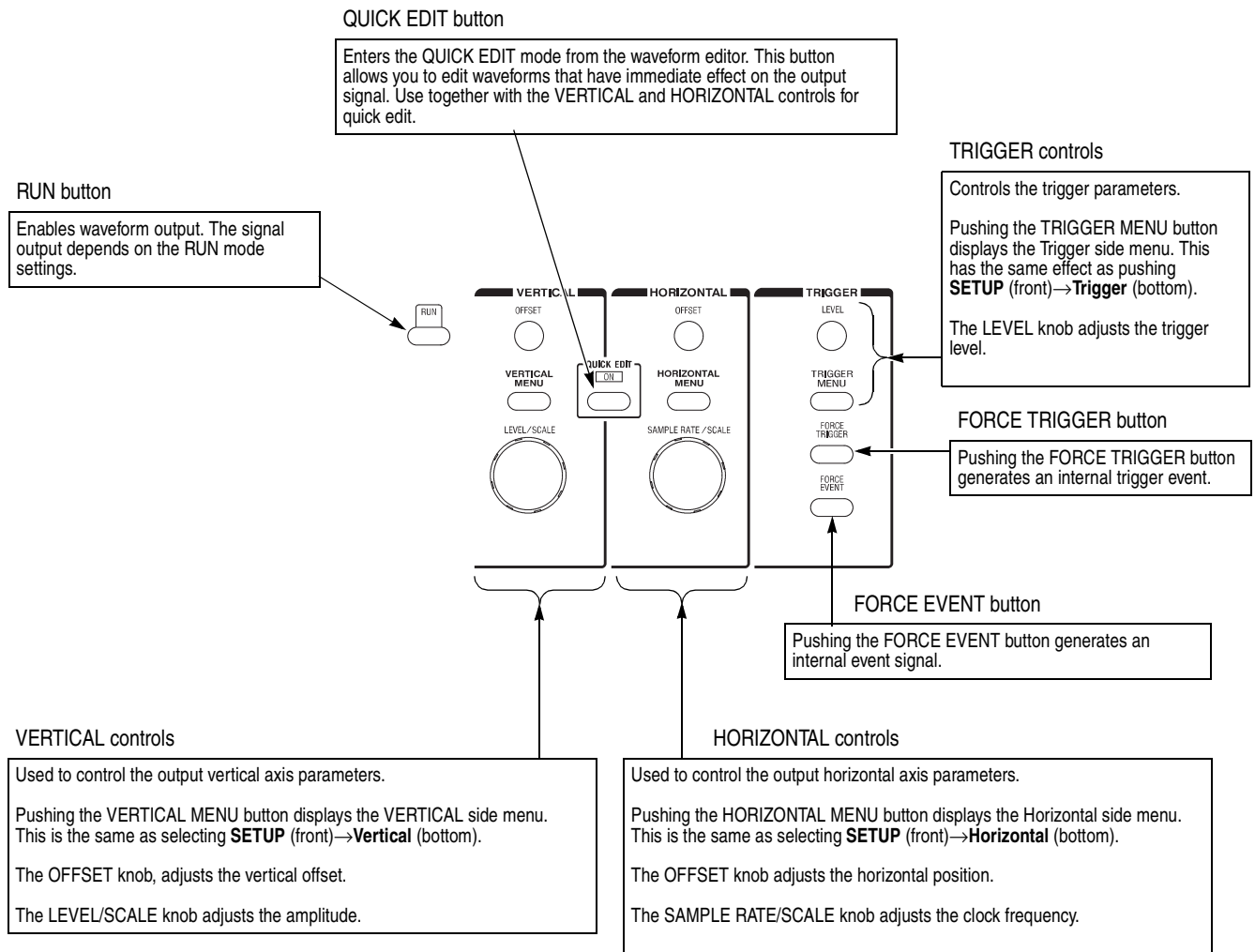

Figure 2-4: Front panel trigger and output controls

Rear Panel Figure 2-5 and 2-6 show the rear panel signal and power connectors.



CAUTION. To prevent damage to the instrument, only apply signals within the stipulated range to the **INPUT** connector.

Do not apply any external voltage to the **OUTPUT** connector.

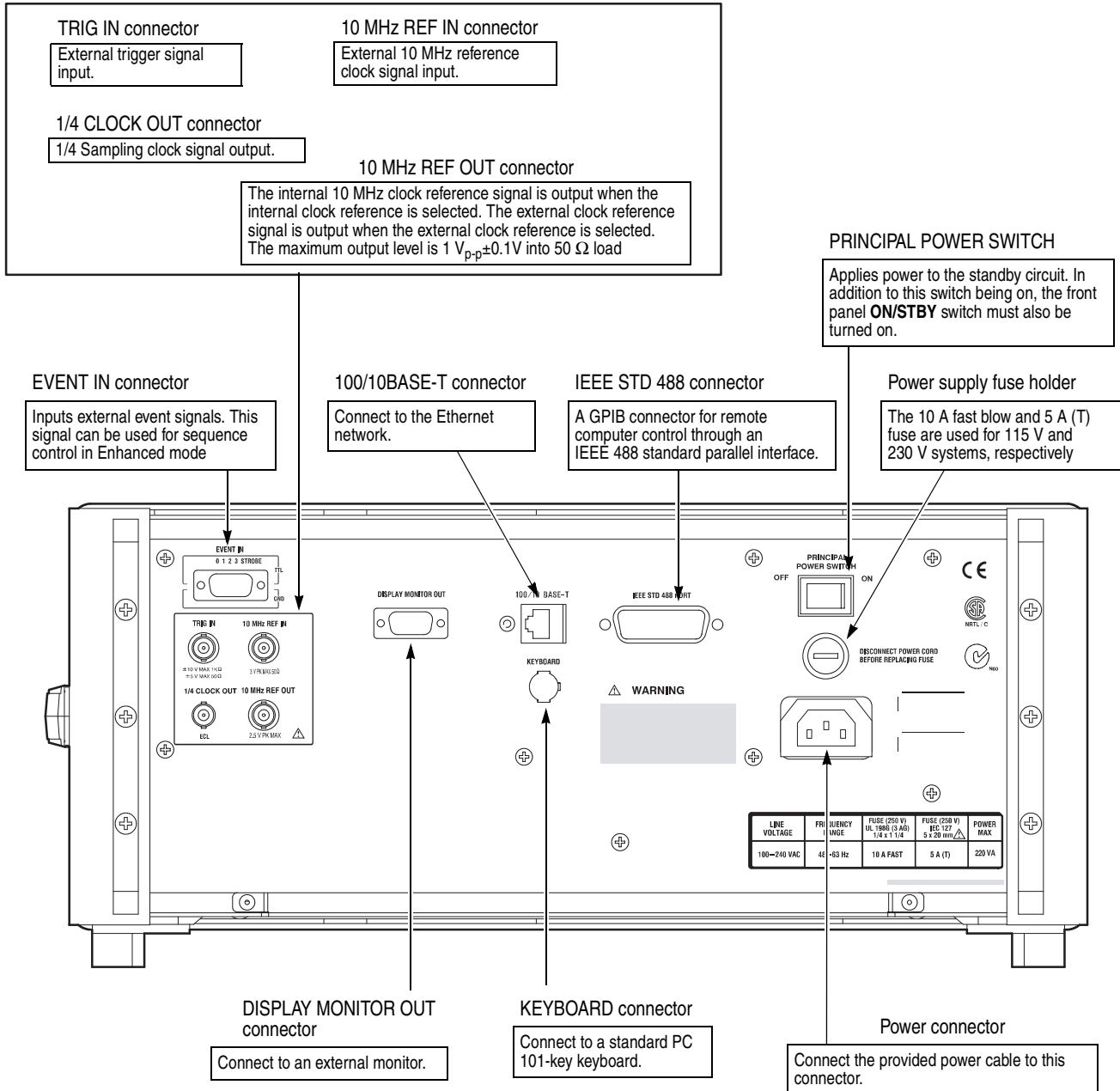

Figure 2-5: Rear panel signal and power connectors (AWG710)

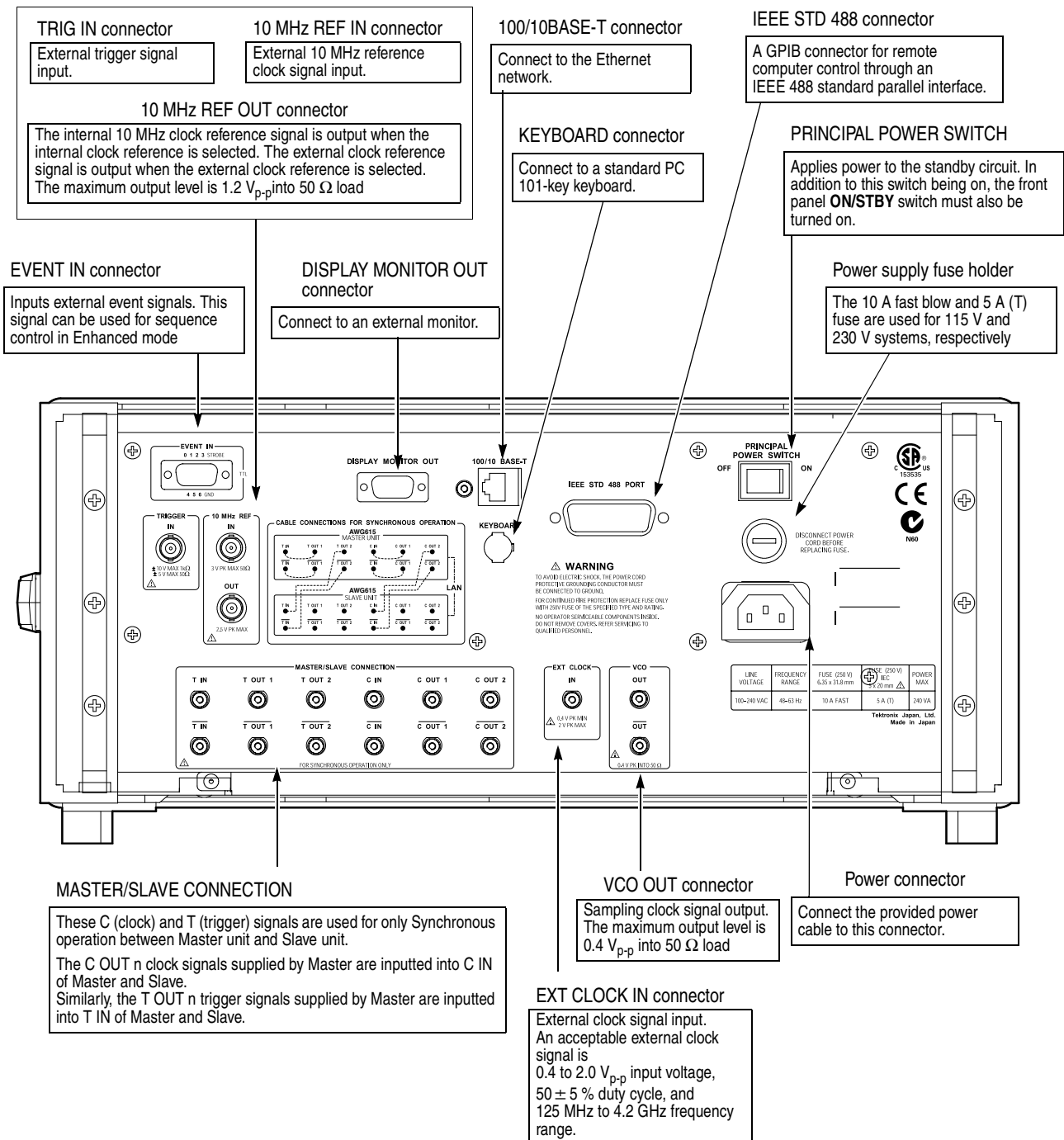

Figure 2-6: Rear panel signal and power connectors (AWG710B)

Menu Operations

This section describes the AWG710&AWG710B Arbitrary Waveform Generator menu system and numeric and text input methods.

Menu System

The AWG710&AWG710B Arbitrary Waveform Generator uses menus to make selections. There are four menu buttons, labeled EDIT, SETUP, APPL, and UTILITY, as shown in Figure 2-7. Pushing a menu button displays the corresponding screen and menu buttons. These menus let you edit waveforms, initialize instrument settings, define instrument operation, and specify waveform output parameters.

You select items within the displayed menu by pushing the bottom or side bezel button nearest to the menu item. These buttons consist of seven bottom buttons and five side buttons, as shown in Figure 2-7. These menu bezel buttons are referred to as bottom menu buttons (or bottom buttons) and side menu buttons (or side buttons).

The **CLEAR MENU** button cancels the current menu operation, clears the current menus from the screen, and exits to the previous instrument state.

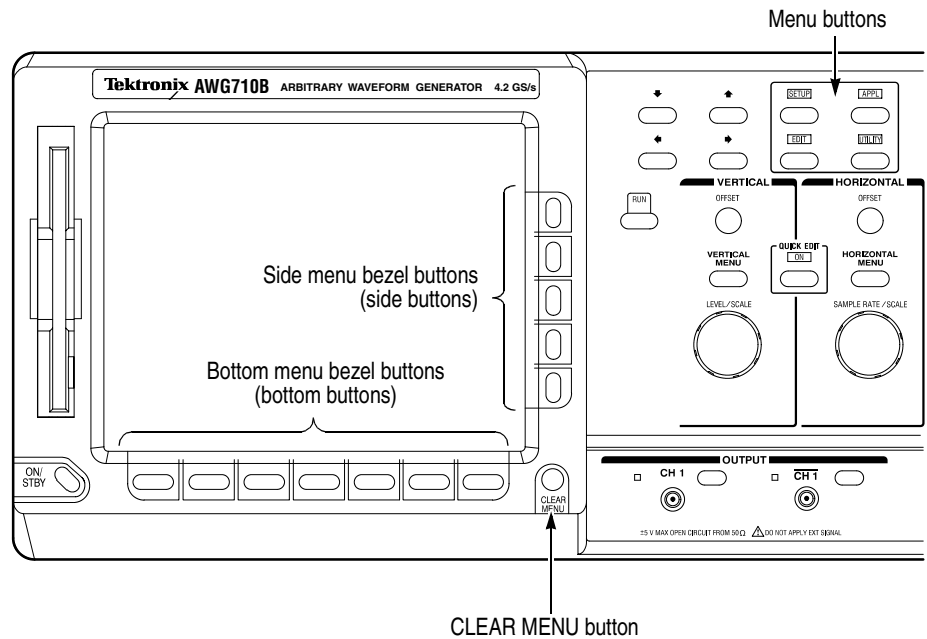

Figure 2-7: Menu buttons, bezel menu buttons, and the CLEAR MENU button

Menu Elements

Pushing a front-panel menu button displays the screen and bottom menu items associated with the button. You select a bottom menu item by pushing the button directly below that menu item.

Pushing a bottom button displays a side menu, pop-up menu, list, or dialog box. Figures 2-8 through 2-10 show examples of the side menu, pop-up menu and dialog box, respectively.

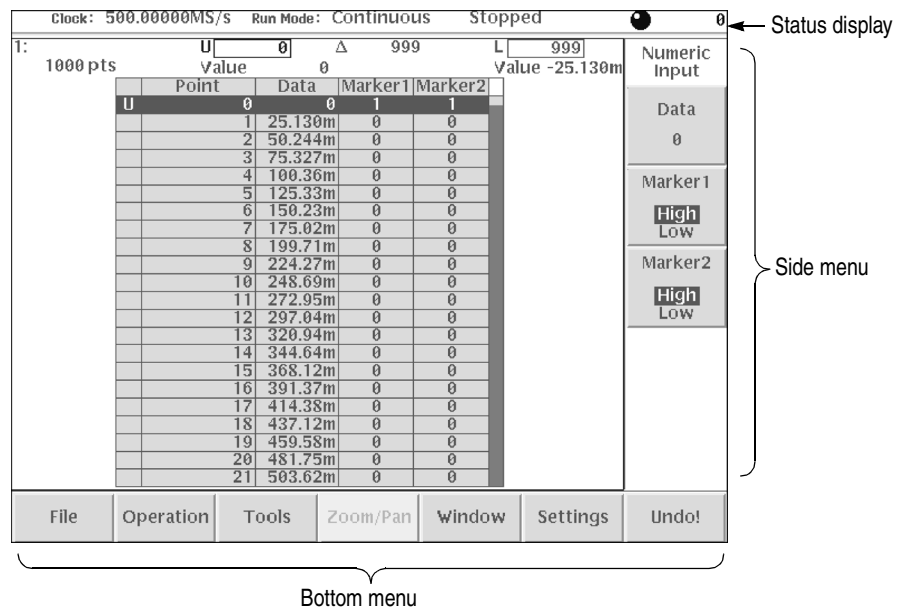

Figure 2-8: Bottom and side menus

You use a side menu button to display a side submenu, set a parameter, perform a task, or cancel an operation. Table 2-1 describes the side menu button types.

Table 2-1: Side menu elements

Menu items	Description	Menu items	Description
External	Executes the displayed function immediately.	Up Level	Cannot be used in the current instrument state (menu item is grayed out).
Output Normal Direct	Switches between two parameters each time the side button is pushed.	Filter 20 MHz	Allows making selections by using the general purpose knob.
Amplitude 1.000Vpp	Allows entering numeric values using the numeric buttons or the general purpose knob.	Marker...	Displays submenus. Note that the label on the item is followed by an ellipsis (...).

The pop-up menu example, shown in Figure 2-9, displays a list of choices from which you make a selection. Use the general purpose knob or the front-panel arrow buttons to move up or down in the list. Push the **OK** side button or the **ENTER** front-panel button to confirm the selected item.

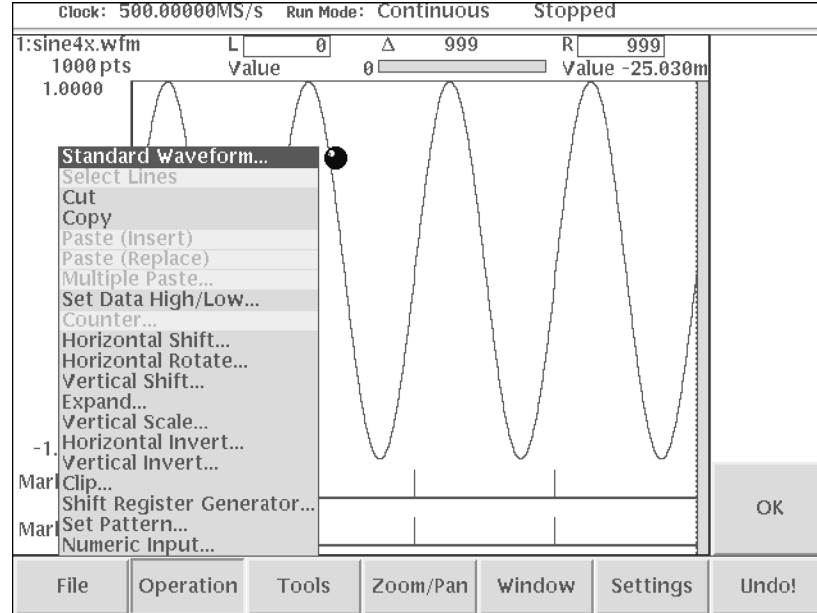

Figure 2-9: Pop-up menu example

The dialog box example, shown in Figure 2-10, displays a form in which you make selections or enter values. Use the front-panel arrow buttons to select items or fields. A selected field or item is highlighted. Use the keypad buttons or the general purpose knob to change values in selected text/numeric fields or change 1-of-N fields. A 1-of-N field contains two or more choices of which only one can be selected at a time.

Push the **OK** side button to confirm the dialog box. Push the **Cancel** side button or the **CLEAR MENU** button to exit the dialog box without making any changes.

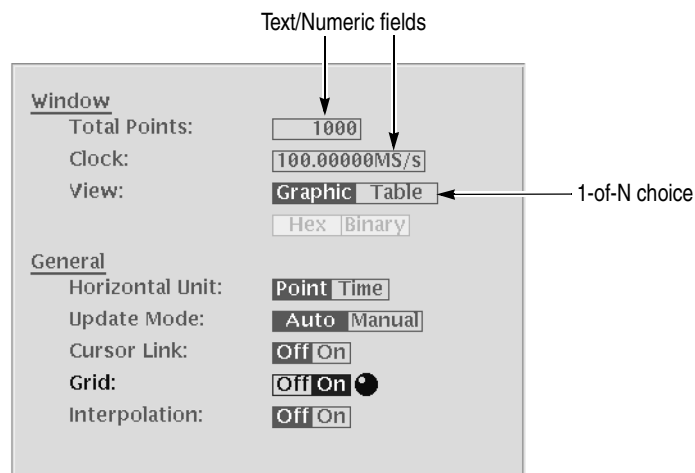

Figure 2-10: Dialog box example

Refer to *Numeric Input* on page 2-12 and *Text Input* on page 2-14 for more information on selecting and entering values in menus and dialog boxes.

Refer to *Menu Structures* on page 3-3 for information on the menu system.

Numeric Input

You can enter numeric values by using either the numeric keypad or the general purpose knob. If the side menu item displays a value, you can alter this value using the general purpose knob or numeric buttons.

Pushing the type of side menu button or selecting a parameter in a pop-up menu causes the current setting to appear on the right end of the Status Display area as shown in Figure 2-11.

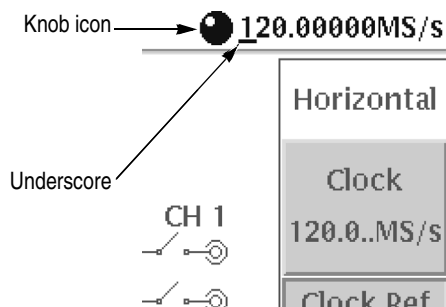

Figure 2-11: Knob icon displayed in Status Display area

The General Purpose Knob

A knob icon with a numeric value that includes an underscore character indicates that you can change the value at the underscore location by using the general purpose knob or keypad buttons. By default, the underscore character is positioned under the digit specified depending on the parameters. You can only change the value represented by the digits at and to the left of the underscore. Use the ◀ and ▶ arrow buttons to move the underscore to the desired position, and then turn the general purpose knob to change the value.

If the numeric value has the knob icon, but does not have the underscore, then turning the general purpose knob cycles through a predefined set of values.

When using the general purpose knob, values you change in side menus and menu screens take effect immediately. Values in pop-up menus are not effective until you push the **OK** side button or the **ENTER** front-panel button.

The Numeric Keypad

Figure 2-12 shows the numeric keypad, with descriptions of the button operations.

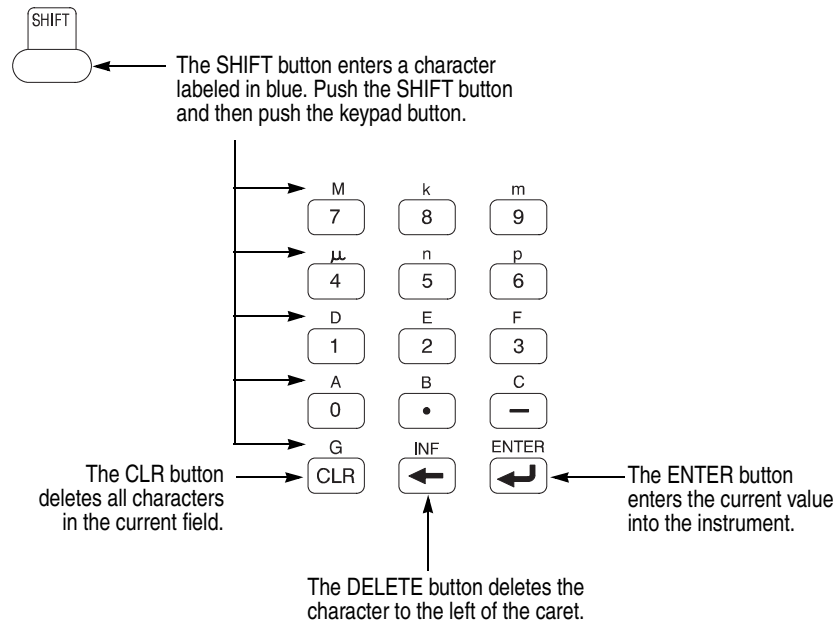

Figure 2-12: Keypad buttons

The G, M, k, m, μ , n, and p are unit buttons. The A, B, C, D, E, and F buttons are used for entering hexadecimal values.

To use the numeric keypad to enter a value, position the caret to where you want to change a value, and then push a keypad button. If you want to enter a unit value labeled in blue just above each numeric button, push or hold down the **SHIFT** button, and then push the corresponding numeric button.

To enter or change more than one character, move the caret to the next position to change. When you are done entering values, push the **ENTER** button to confirm the changes and enter them into the instrument. For example, to enter 200.5 μ s, push **2**, **0**, **0**, **.**, **5**, **SHIFT** and **4** (μ) buttons in this order.

When you enter a value larger than the maximum value in the range for the parameter, the parameter will be set to the maximum value. When you enter a value smaller than the minimum value, the minimum value will be set in the parameter. To set to the maximum or minimum value, enter a larger value or smaller value. This is useful when you do not know the range that can be set.

Note that the current unit is always kept when you just use the **ENTER** after entering digits. For example, suppose that the Clock is currently set to 100.0 MS/s. When you press the **5**, **0** and **ENTER** buttons in this order, the Clock will be set to 50.0 MS/s. To set the Clock to 500 kS/s, press **0**, **.**, **5** and **ENTER** buttons, or **5**, **0**, **0**, **SHIFT**, and **8** (**k**) buttons in this order.

Text Input

When you need to assign a name to a waveform file or equation, or a IP address to the instrument, the instrument displays a text dialog box. See Figure 2-13. The text field is where you enter or change an existing character string. The character palette is where you select alphanumeric characters to insert into the text field. You can also select equation or file names from the name list to insert into the text field.

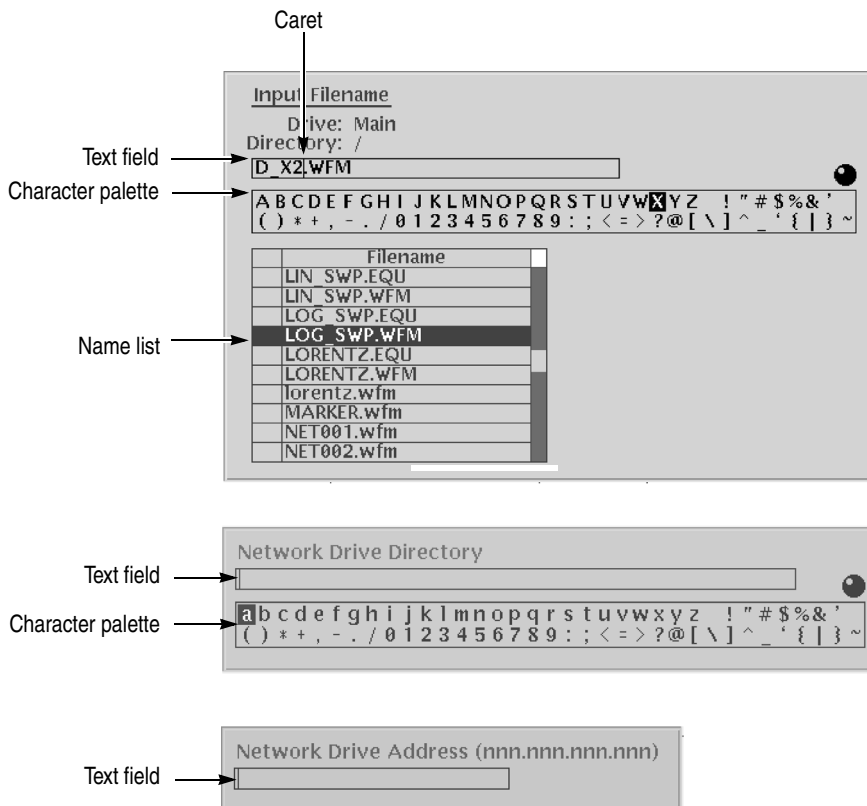

Figure 2-13: Three type of Input text dialog boxes

To select a character from the character palette, use the general purpose knob to highlight a character, and then push the **ENTER** to insert the character into the text field. Repeat this step until you have entered all characters in the text field. By default, the character palette is selected. To select text from a file name list, use the ▲ and ▼ arrow buttons to move the knob icon to the file name list. Table 2-2 describes all the controls you can use for entering and editing text.

Table 2-2: Text input button functions

Control	Description
General purpose knob	Selects the character to insert into the text field.
◀ and ▶ arrow buttons	Moves the character insertion caret left or right in the text field.
ENTER button	Inserts the selected character or character string into the text field.
← button	Deletes one character to the left of the caret.
CLR button	Clears the entire text field.
Numeric buttons	Enters numeric characters into the text field.
SHIFT button	Enters a selected character in upper case. When you push the SHIFT button, the SHIFT LED lights. When the dialog box disappears, the SHIFT LED also goes off.

Shortcut Controls

Figure 2-14 shows the shortcut buttons and knobs that control specific instrument setup parameters. Using the shortcut controls lets you adjust the output setup parameters even while you are displaying another menu. Table 2-3 describes the shortcut controls.

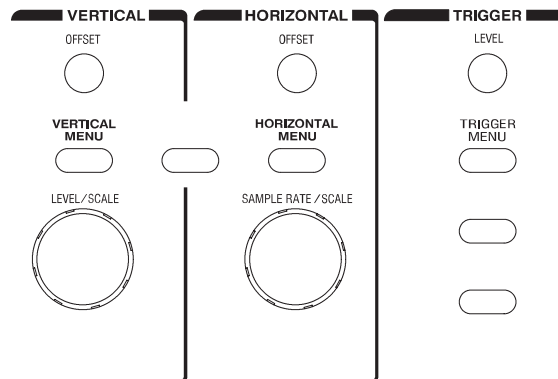

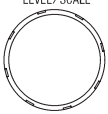

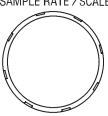



Figure 2-14: Shortcut controls

Table 2-3: Shortcut controls

Controls	Description
<p>VERTICAL</p> 	<p>Displays the Vertical side menu. This is the same operation as selecting SETUP (front)→Vertical (bottom).</p>
	<p>Adjusts the vertical offset parameters. This is the same as selecting SETUP (front)→Vertical (bottom)→Offset (side), and then turning the general purpose knob. (except option 02)</p>
	<p>Adjusts the amplitude parameters. This is the same as selecting SETUP (front)→Vertical (bottom)→Amplitude (side), and then turning the general purpose knob.</p>
<p>HORIZONTAL</p> 	<p>Displays the Horizontal side menu. This is the same as selecting SETUP (front)→Horizontal (bottom).</p>
	<p>Adjusts the clock setting. This is the same as selecting SETUP (front)→Horizontal (bottom)→Clock (side), and then turning the general purpose knob.</p>
<p>TRIGGER</p> 	<p>Displays the Trigger side menu. This is the same as selecting SETUP (front)→Trigger (bottom).</p>
	<p>Adjusts the trigger level setting. This is the same as selecting SETUP (front)→Trigger (bottom)→Level (side), and then turning the general purpose knob.</p>

File Management

This section is an overview of the instrument commands and operations for doing file management tasks. Refer to *File Management* on page 3-225 for more information.

File Type Extensions

The AWG710&AWG710B Arbitrary Waveform Generator uses numerous file formats to hold different types of data. These file types are listed in Table 2-4. Note that the instrument checks the file format and processes the file based on its content, regardless of the file extension.

Table 2-4: AWG710&AWG710B Arbitrary Waveform Generator file types

Files	Description
Waveform file	Use .wfm or .WFM suffix for identification. Contains waveform data. All signal data must be in waveform format before it can be output. Created with the waveform editor, by compiling an equation file, or by converting to waveform format when importing waveforms from external equipment.
Pattern file	Use .pat or .PAT suffix for identification. Contains pattern data. Created with the pattern editor.
Sequence file	Use .seq or .SEQ suffix for identification. Contains waveform sequence and trigger data. Created with the sequence editor.
Equation file	Use .equ or .EQU suffix for identification. Contains equations or functions that describe a waveform. Created with the equation/text editor. Both text editor and equation editor assign .txt suffix by default, but use .equ suffix to avoid confusion with normal text file.
Text file	Use .txt or .TXT suffix for identification. Contains ASCII text. Created with the equation/text editor.
Setup file	Use .set or .SET suffix for identification. Contains instrument setup and configuration data of both AWG and FG mode. Created from the SETUP menu.

Locating Files

There are three locations for storing waveform data on the AWG710&AWG710B Arbitrary Waveform Generator. Data can be stored on the instrument hard disk drive, the instrument floppy disk drive, or a remote storage device accessible through the Ethernet interface. If the file you want to load is not on the current drive, use the EDIT menu main screen **Drive** and **Directory** bottom menu buttons to open side menus that let you change the current drive location. Table 2-5 describes the Drive and Directory bottom buttons.

Table 2-5: Drive and Directory menus

Bottom menu	Side menu	Description	
Drive	Main	Changes the instrument current drive. To select a drive, push the appropriate side menu button. Note that there must be a floppy disk inserted in the instrument floppy disk drive to select the floppy drive. Note that the label Net1, Net2 and Net3 vary depending on the net name settings in the UTILITY menu.	
	Floppy		
	Net1		
	Net2		
Directory	Net3	Moves up a directory level.	
	Up Level		
	Down Level		Moves down a directory level. To move down a directory level, select a directory name in the pop-up list, and then push the Down Level side button. The filename list changes to show the contents of the directory.
	Make Directory		Creates a directory at the current level. To create a directory, push the Make Directory side button to display the Input New Directory Name dialog box. Enter the directory name in the name field, then push the OK side button. The instrument creates the new directory.
	Archive		Creates a new file (.tar format) for archive from selected directory. The archived file keeps hierarchic structure.
Extract	Restore the archived file (.tar) to the current directory.		

NOTE. In the following procedures, you may have to push the *EDIT* button twice to quit the editor. When the instrument does not display the file list, push the *EDIT* button again. Refer to Saving Files on page 2-21.

Copying Files Do the following steps to copy a file (single window):

1. Push **EDIT** (front).
The instrument displays the file list.
2. Select the file to copy.
3. Push **File** (bottom)→**Copy** (side)
4. Enter the new name for the copied file in the file name field
5. Push **OK** (side).

The file is copied and renamed. Also refer to page 3-230 for more information on the double windows.

NOTE. You can copy a file or all files in another way. Refer to Copying Files on page 3-227 for those methods.

You can also move a file or all files. Refer to Moving Files on page 3-228 for those methods.

Renaming Files Renaming files is similar to Copying files, but the original files are deleted. Do the following steps to rename a file:

1. Push **EDIT** (front).
The instrument displays the file list.
2. Select the file to rename.
3. Push **File** (bottom)→**Rename** (side).
4. Enter the new name for the file in the file name field.
5. Push **OK** (side).

The file is renamed.

Deleting Files Do the following steps to delete a file:

1. Push **EDIT** (front). The instrument displays the file list.
2. Select the file to delete.
3. Push **File** (bottom)→**Delete** (side). The instrument displays a message box asking you to confirm deleting the file.
4. Push **OK** (side) to delete the file, or **Cancel** to cancel the operation and keep the file.

You can also delete all files on the current drive and directory by doing the following steps:

1. Push **EDIT** (front)→**File** (bottom)→**Delete All** (side).
The instrument displays a message box asking you to confirm deleting all files.
2. Push **OK** (side) to delete all files, or **Cancel** to cancel the operation and keep all files.

Read Only Attribute You can change the read only or read/write attributes on a file. Do the following steps to change the file attribute:

1. Push **EDIT** (front).
The instrument displays the file list.
2. Select the file to change the attribute.
3. Push **File** (bottom)→**Attribute xxxx** (side).

The **xxxx** is the **Read/Write** or **Read Only** attribute of the selected file. Pushing this side button immediately changes the file attribute.

The file with a read only attribute is marked by  , and the directory by  . See Figure 2-15.

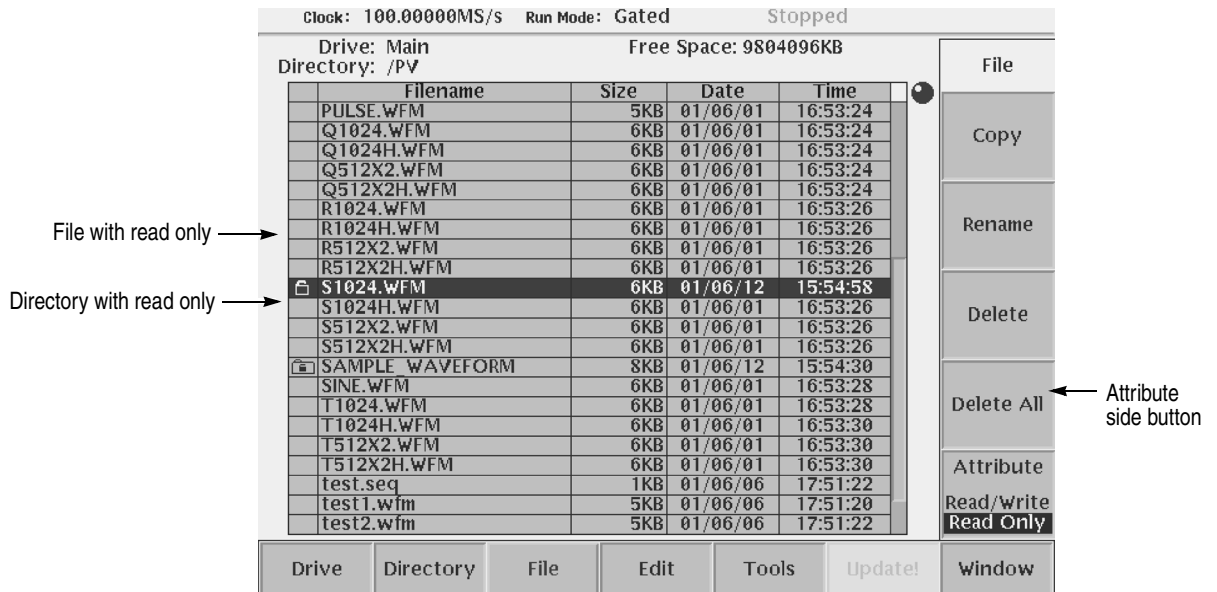

Figure 2-15: Files and directories with read only attribute

Saving Files

You can save files from each editor screen. You have the choice of saving your waveform data to the current file name or to a new file name. To save a waveform to its current file name, push **File** (bottom)→**Save** (pop-up)→**OK** (side).

If you are saving a waveform for the first time, the instrument opens the Input Filename dialog box, shown in Figure 2-16. Use this dialog box to enter a file name. If necessary, you can select a different storage media or directory by pushing the **Drive...** side menu button. Enter the file name, then push the **OK** side button or the **ENTER** front-panel button to close the dialog box and save the file.

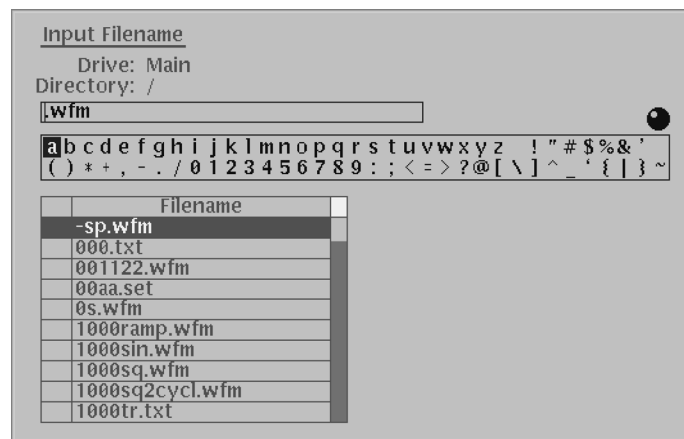

Figure 2-16: Input Filename dialog box

NOTE. When you exit an editor without saving edited data, the instrument displays the message Save the changes you made? Push the **Yes** side button to save the waveform data.

To save waveform data to a new file name, push **File** (bottom)→**Save As** (pop-up)→**OK** (side). The instrument opens the Input Filename dialog box, shown in Figure 2-16. Use this dialog box to enter a file name. If necessary, you can select a storage media or directory by pushing the **Drive...** side menu button. Enter the file name, then push the **ENTER** front-panel button to close the dialog box and save the file.

If you are saving a file with a record length larger than 960 data points and the record is not evenly divisible by four, the instrument needs to adjust the record length to meet internal memory record length requirements. The instrument displays one of the messages shown in Table 2-6. You can push the **OK** side button to accept the recommended change, or cancel the save and then edit the file to satisfy the data record length requirements.

Table 2-6: Waveform record length adjustment messages

Message	Description
Leave as it is	The data is saved, as it is, without making changes. The instrument will display an error message if you try to load a file that does not meet the instrument waveform constraints.
Append 0	With Level-0 data added after the data, a file with a data length meeting the requirements is created.
Expand	With the waveform data expanded, a file with a data length meeting the requirements is created.
Expand with Clock	With the waveform data expanded, a file with a data length meeting the requirements is created. In addition, the clock frequency increases without change in scaling factor. The settings are saved in the file.
Repeat	With repetitions of the original data linked, a file with a data length meeting the requirements is created. If the total length of the linked data exceeds 16M/32M (option 01) points, this will cause an error.

Archive, Extract

To archive or extract files, do the following steps.

Archive. When you select Directory in the file list, you can make archives for all the files in the directory and subdirectory.

1. Push **EDIT** (front).
The instrument displays the file list.
2. Select the file to make archive files.

3. Push **Directory** (bottom)→**Archive** (side).

The instrument displays the Input archive name dialog box. By default, the name of <directory name>.tar is automatically assigned. If necessary, you can change the name.

4. Push **OK** button, and the archive file will be created in the current directory.

Extract. The archived file is extracted (restored) to the current directory. If the directory already exists, the existing file will be overwritten.

1. Push **EDIT** (front).

The instrument displays the file list.

2. Select the file to extract.
3. Push **Directory** (bottom)→**Extract** (side).

The instrument extracts the archived files and directories to current directory.

Remote computer archive operation. AWG710&AWG710B Arbitrary Waveform Generator uses .tar format files. Use the **tar** command when you archive with a remote computer environment. If you are PC user, use **tar** format archive tool.

The following list describes some restrictions on archive and extract operation.

- Blocking factor is 20.
- The file name including the file path in the directory is up to 100.
- The depth of directory hierarchy is up to 16.

Use the following command to make archive file:

```
tar [-] cvf <tar file name> <file name or directory name>
```

Use the following command to extract archive file:

```
tar [-] xvf <tar file name>
```

Quick View

Before loading or handling a file, you sometimes want to look at the content of a file to confirm the operation. The quick view function displays the view window and allows you to view a waveform or pattern file selected in a file list. This function is always available when a file list is displayed on the screen. See Figure 2-17.

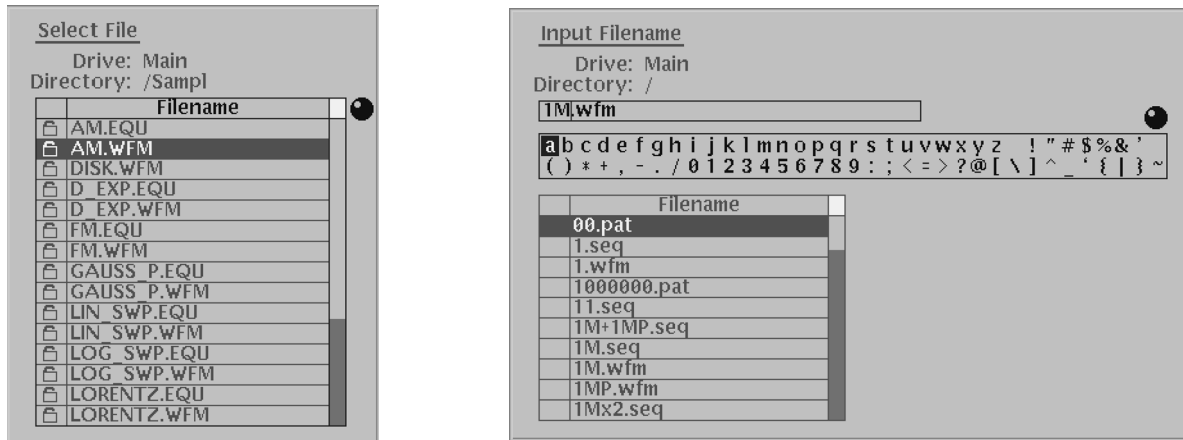

Figure 2-17: File list window examples in which Quick View is available

Select a file from the file list window using the general purpose knob. Press the **SHIFT** and **ENTER** front-panel buttons simultaneously. The view window displaying the waveform or pattern appears as shown in Figure 2-18.

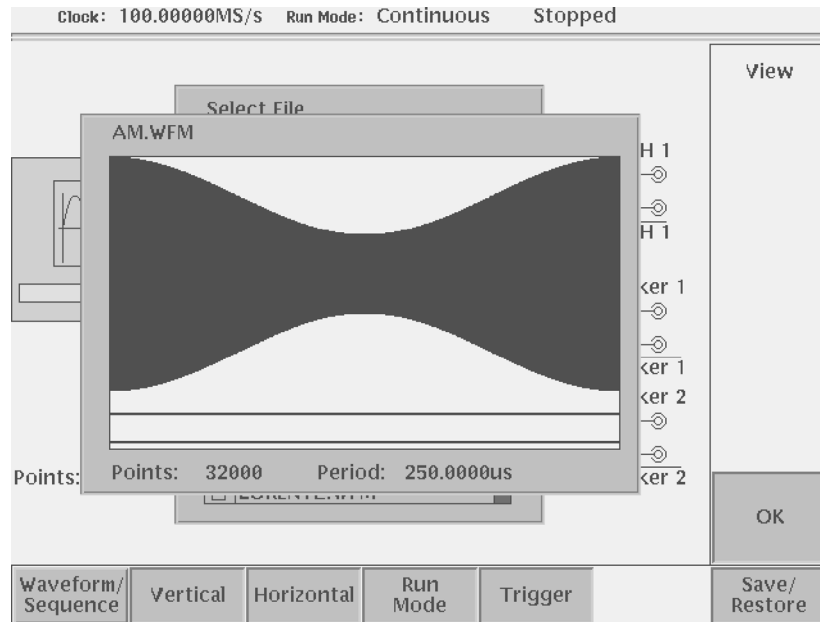

Figure 2-18: Viewing a file by Quick View function

Push the **OK** side menu button to close the view window. You cannot view files other than waveform or pattern in this function.

This function is always available when a file list window or file list dialog box is displayed on the screen.

Editor Overview

This section introduces the editor screen, describes the screen elements, and discusses concepts common to most of the editors. Refer to the *Reference* section for more detailed information about each waveform editor.

This section also provides an overview of the AWG710&AWG710B Arbitrary Waveform Generator waveform editors. There are five editors that provide the tools for creating simple or complicated waveforms. Having more than one editor allows you to create waveforms using your preferred method or the one best suited to the waveform type.

The Edit menu, displayed by pushing the EDIT front-panel button, is the main way to open editors. Most of the editor screens have common elements except for the Sequence and Equation editors.

Editor Modes

The AWG710&AWG710B Arbitrary Waveform Generator provides five editor modes, as listed in Table 2-7. These editors let you create, edit, and sequence waveforms using the technique best suited to your waveform. You can access these editors through the main Edit screen, which is described on page 2-27.

Table 2-7: Editors

Editors	Description
Waveform Editor	Creates and edits analog waveforms.
Quick Editor	Lets you modify and/or output, in real time, any part of a waveform you are currently editing with the Waveform Editor.
Pattern Editor	Creates and edits digital waveform patterns.
Sequence Editor	Creates and edits tables that define the sequence and control conditions for outputting one or more waveforms.
Text/Equation Editor	Creates, edits, and compiles equation waveform definitions into a waveform file. You can also use this editor to edit ASCII-format waveform data files created by other equipment (such as Tektronix Digital Sampling oscilloscopes).

Main Edit Screen

To display the main Edit screen, push the **EDIT** front-panel button. If there is no waveform file currently loaded into the edit buffer, the instrument displays the main Edit screen and a list of files in the current drive, as shown in Figure 2-19. Table 2-8 lists the bottom menu button functions. If there is a waveform loaded for editing, the screen will show the loaded waveform in the appropriate editor.

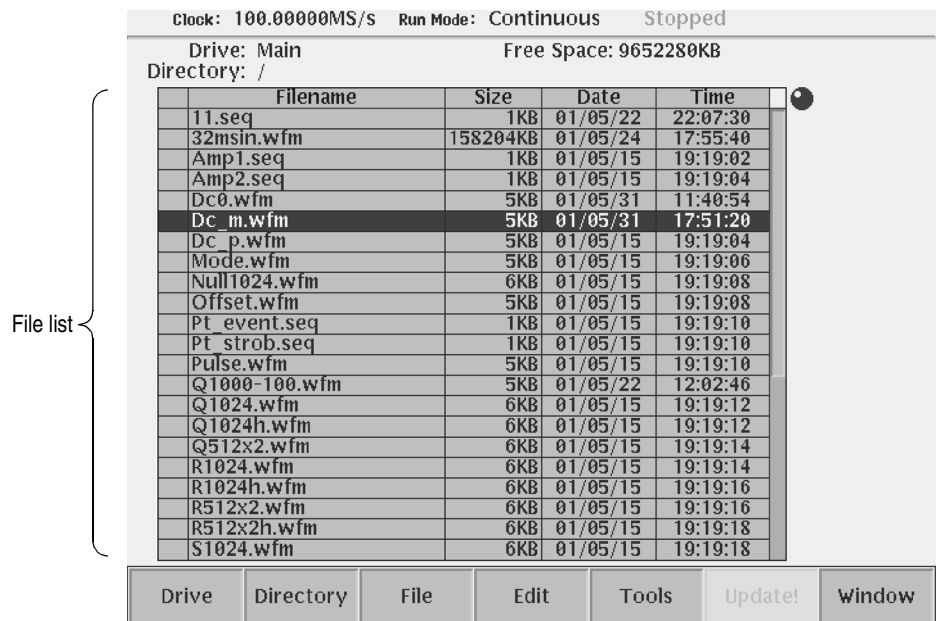

Figure 2-19: Main Edit screen

Table 2-8: Edit screen bottom menu buttons

Button	Description
Drive	Specifies the current drive to use for loading or storing waveform files
Directory	Lets you navigate and create directories on the current drive
File	Lets you copy, rename, delete, and assign attributes to files on the current drive
Edit	Displays the Edit side menu for editing existing or new waveform files
Tools	Displays the Tools side menu for importing and converting file data
Update!	Updates the waveform file name list. Becomes available during the file lists on the Net Drive are displayed.
Window	Lets you open a single window or double window that displays a file list of a specified directory or drive. Refer to page 3-230 for information about double windows.

Loading a Waveform File to Edit

The default Edit screen displays a list of files in the current drive. To load a file and open an editor window, use the general purpose knob or the front-panel arrow buttons to highlight a file name. Then push the **ENTER** front-panel button. The instrument loads the selected file and opens the editor appropriate for that file type. You can also edit an existing file by selecting the file in the list, pushing the **Edit** bottom button, then pushing the **Edit** side button. This process takes two more steps than that described previously. If the file you want to edit is located in a different directory of the hard disk drive, on a floppy disk, or on a network drive, use the bottom menu **Drive**, **Directory**, and **File** buttons to change the current drive and load a file from another location. Refer to *File Management* on page 2-17 for information on locating and saving files.

Creating a New Waveform

To create a new waveform file, push the **Edit** bottom menu button. This displays the Edit side menu items as shown in Figure 2-20. Table 2-9 provides an overview of the Edit side menu button functions.

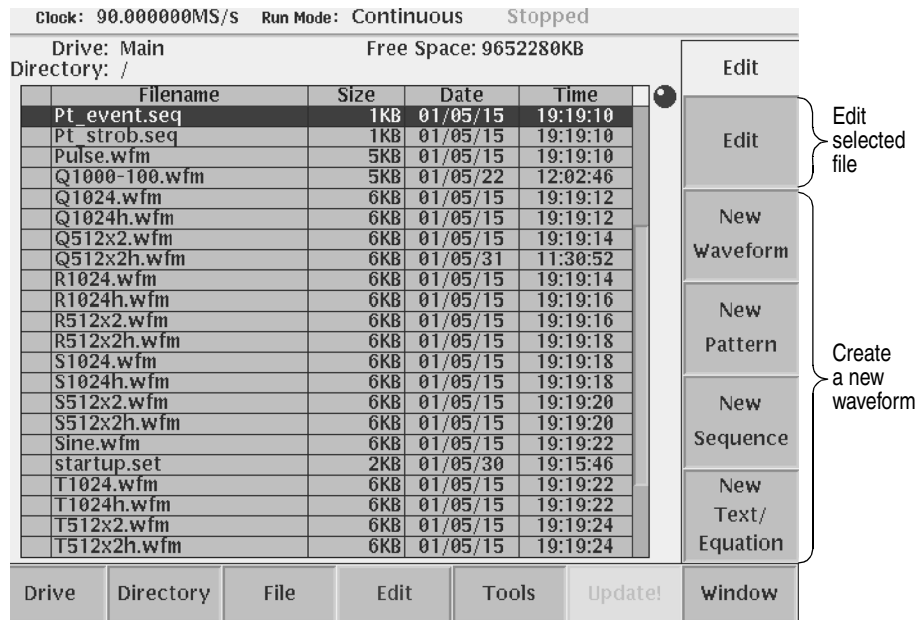

Figure 2-20: Edit top level menu screen with Edit side menu

Table 2-9: Edit side menu buttons

Button	Description
Edit	Loads the selected waveform file and opens the appropriate editor screen
New Waveform	Opens a new Waveform Editor screen
New Pattern	Opens a new Pattern Editor screen
New Sequence	Opens a new Sequence Editor screen
New Text/Equation	Opens a new Equation Editor screen

Editor Screen Elements

Figure 2-21 shows elements that are common to many of the editor screens. What elements are in an editor depends on which editor is open. The *Reference* section describes each editor in detail. Refer to Figure 2-21 to familiarize yourself with the common screen elements of most of the editors.

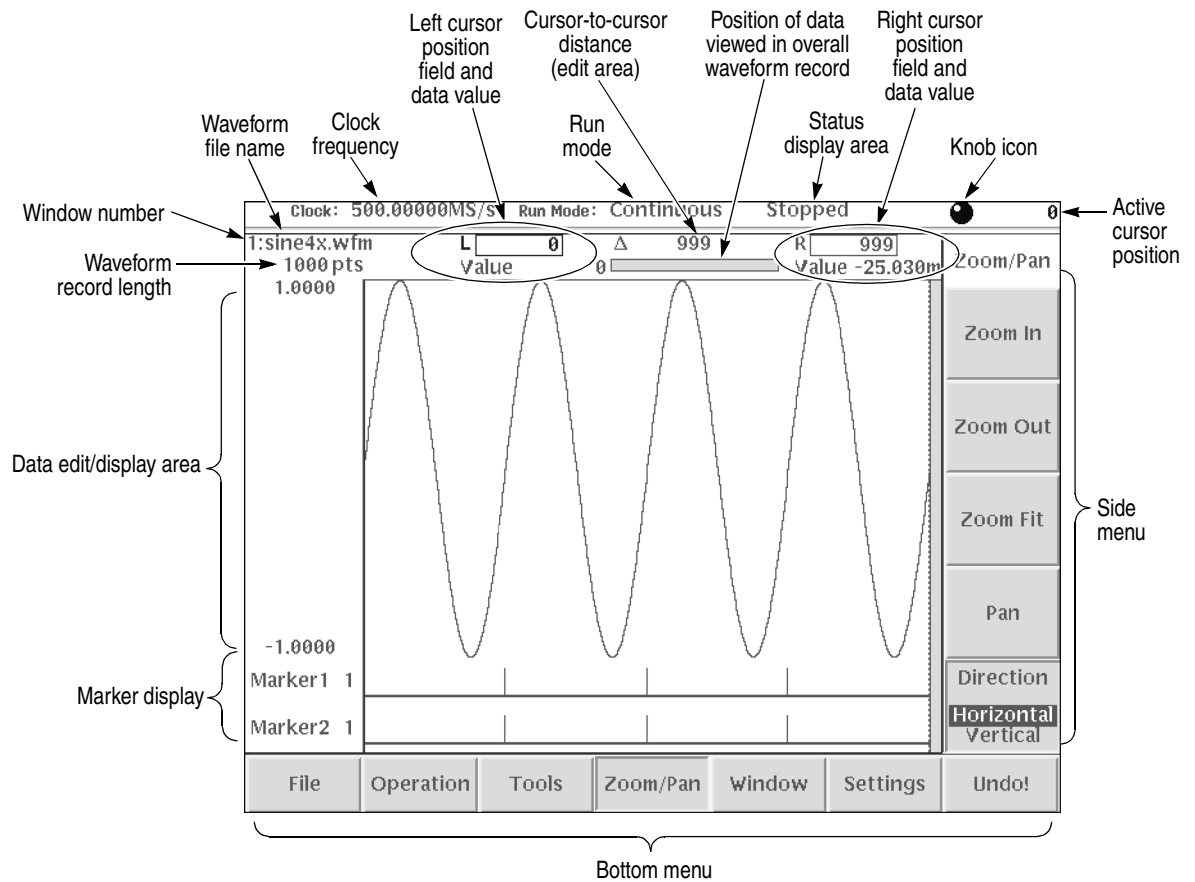

Figure 2-21: Editor screen elements

Cursors and Editing

The edit window cursors define the data affected by all edit operations except the Tools menu commands. Most of the edit commands affect the data located between the left and right cursor positions. This region is called the edit area or scope. Figure 2-22 shows an example of an edit area. In this example, all data is located from left cursor position 300 to right cursor position 779.

Other edit operations use the active (selected) cursor position for inserting waveform data. The active cursor is shown as a solid vertical line. The inactive cursor is shown as a dashed vertical line.

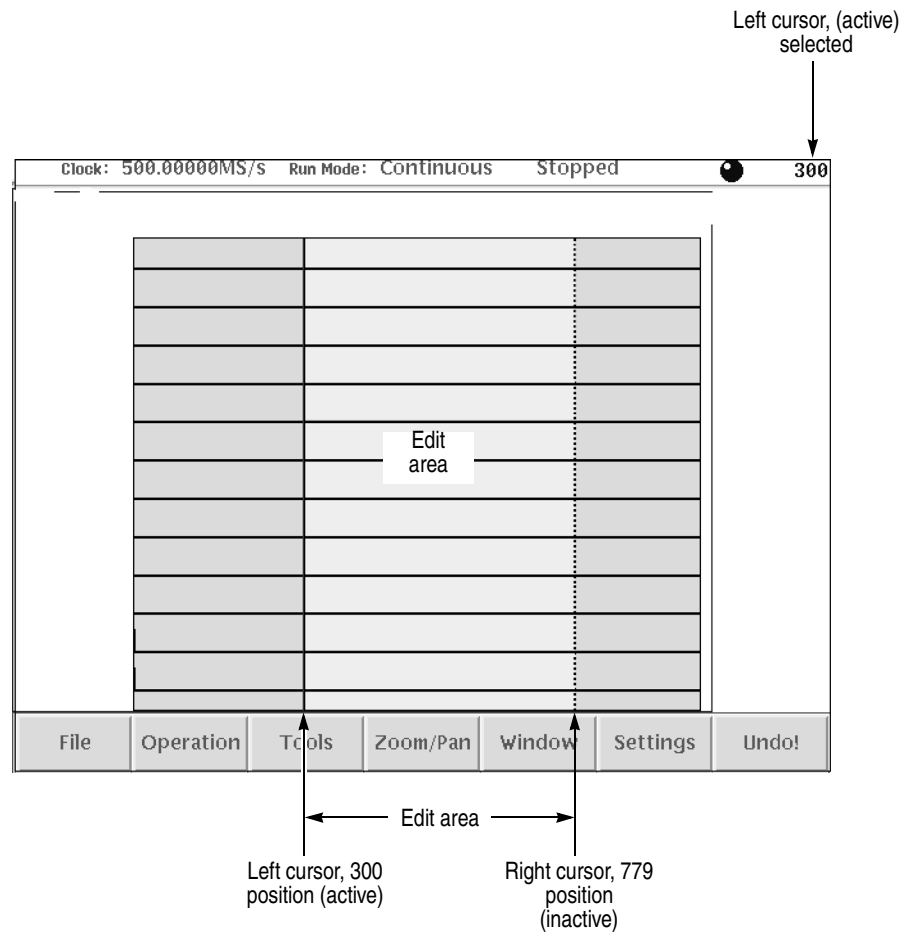

Figure 2-22: Cursors and edit area

When you edit a waveform, you must first specify the edit area or a single cursor position, depending on the operation you want to do. To select the active cursor, push the **TOGGLE** front-panel button to switch between the left and right cursor. To move a cursor, turn the general purpose knob, use the left or right arrow keys, or use the keypad or keyboard to enter a position in the cursor position field. The cursor position field is active when the corresponding cursor is active.

Followings are more cursor operations that are available by using the SHIFT button on the front-panel:

- Push the **SHIFT** front-panel button then turn the general purpose knob to accelerate the cursor transfer speed.
- Push the **SHIFT** front-panel button then push the **TOGGLE** front-panel button to move the inactive cursor to the active cursor position (the two cursors overlap).
- Push the **SHIFT** front-panel button then push the **ENTER** front-panel button to move left cursor to 0 point and to move the right cursor to the maximum point.

Multiple Editor Windows

The AWG710&AWG710B Arbitrary Waveform Generator can open and edit up to three waveform and/or pattern files, in any combination. The waveform data is displayed in separate windows, with each window stacked vertically on the screen. Multiple editor windows are very useful for creating a new waveform by cutting and pasting waveform data from other files. Figure 2-23 shows an example of three opened editor windows (one pattern and two waveform files).

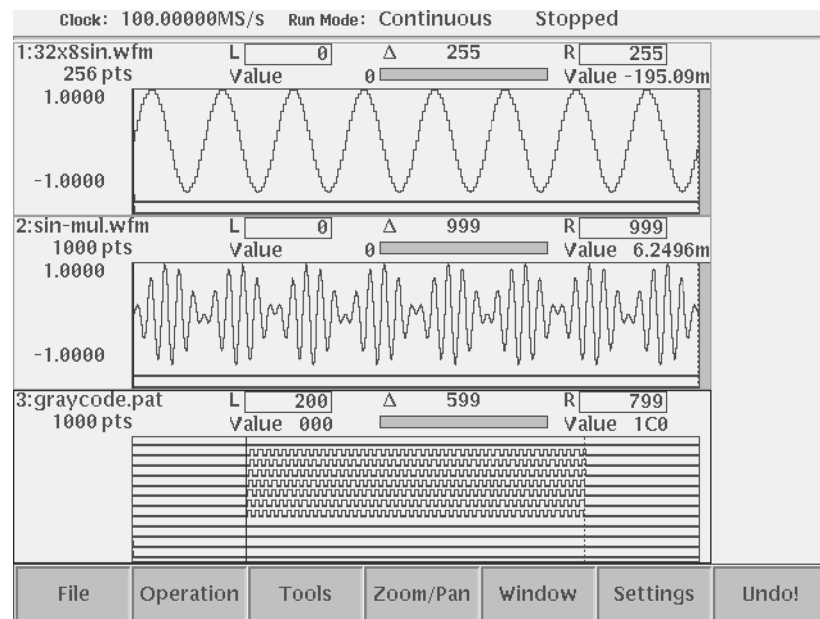

Figure 2-23: Multiple editor windows

NOTE. *You cannot open a sequence, text, or equation file from the Waveform or Pattern Editor. If you are in the Waveform or Pattern Editor, you must exit to the EDIT menu main screen and then load the sequence, text, or equation file.*

Some editor information is not displayed when three Waveform editor windows are open.

Opening Multiple Editor Windows. Do the following steps to load waveform data file into an editor window:

1. From the editor screen, push **File** (bottom)→**Open...** (pop-up)→**OK** (side).
The Select File dialog box appears. If you cannot select the Open... menu item, you already have three windows opened.
2. Select a waveform or pattern file from the Select File list.
If necessary, use the **Drive...**, **Up Level**, or **Down Level** side menu to select the location where the file to load is located.
3. Push the **OK** side button.
The instrument opens a new window for the waveform or pattern data, stacking the windows vertically to fit on the screen. If you attempt to load a sequence, text, or equation file, you will receive an error message.

Creating a New Waveform or Pattern in a Multiple Editor Window. To create a new empty Waveform or Pattern Editor window, push **File** (bottom)→ **New Waveform** or **New Pattern** (pop-up)→**OK** (side). The instrument opens a new window for the waveform or pattern editor, stacking the windows vertically to fit on the screen. If you cannot select the New Waveform or New Pattern pop-up menu item, you already have three editor windows opened.

Selecting the Active Edit Window. Although you can have up to three open editor windows, you can only do editing tasks in one window at a time. To select the active window, push **Window** (bottom)→**Window1**, **Window2**, or **Window3** (side). All editing operations will affect the waveform data in that window until you change to another editor window.

Quitting Editors There are three methods to quit an editor.

Using the File Bottom Menu.

1. Push **File** (bottom)→**Close** (pop-up) to quit the waveform and pattern editors

or

push **File** (bottom)→**Close** (side) to quit the sequence and text/equation editors.

2. If you have made no modifications to the data, the editor is immediately exited. If you have made modifications, the message box *Save the changes you made?* appears. Push the **Yes**, **No**, or **Cancel** side button.

Using the Window Bottom Menu.

You can close the window by using **Window** (bottom) menu for waveform editor and pattern editor.

1. Push **Window** (bottom) → **Close Selected Window** or **Close Unselected Window** (side).

Close Selected Window closes current window and **Close Unselected Window** closes the window which is currently unselected.

2. If you have made no modifications to the data, the editor is immediately exited. If you have not saved the data after modifications, the message box *Save the changes you made?* appears. Push **Yes**, **No**, or **Cancel** side button.

Using the EDIT Button.

1. Push **EDIT** button on the front-panel.
2. If you have made no modifications to the data, the editor is immediately exited. If you have not saved the data after modifications, the message box *Save the changes you made?* appears. Push **Yes**, **No**, or **Cancel** side button.

Refer to page 2-21 for saving files.

Setup Overview

The Setup screen is where you load and set up the waveform for output. This section gives you an overview of the Setup screen, how to load a file, how to set the signal output parameters, and how to enable signal output. Refer to *The Setup Menu* on page 3-33 in the *Reference* section for more information.

Main Setup Screen

To display the main Setup screen, push the **SETUP** front-panel button. The instrument displays the main Setup screen as shown in Figure 2-24. Table 2-10 describes the screen waveform parameter icons. Table 2-11 lists the bottom menu functions.

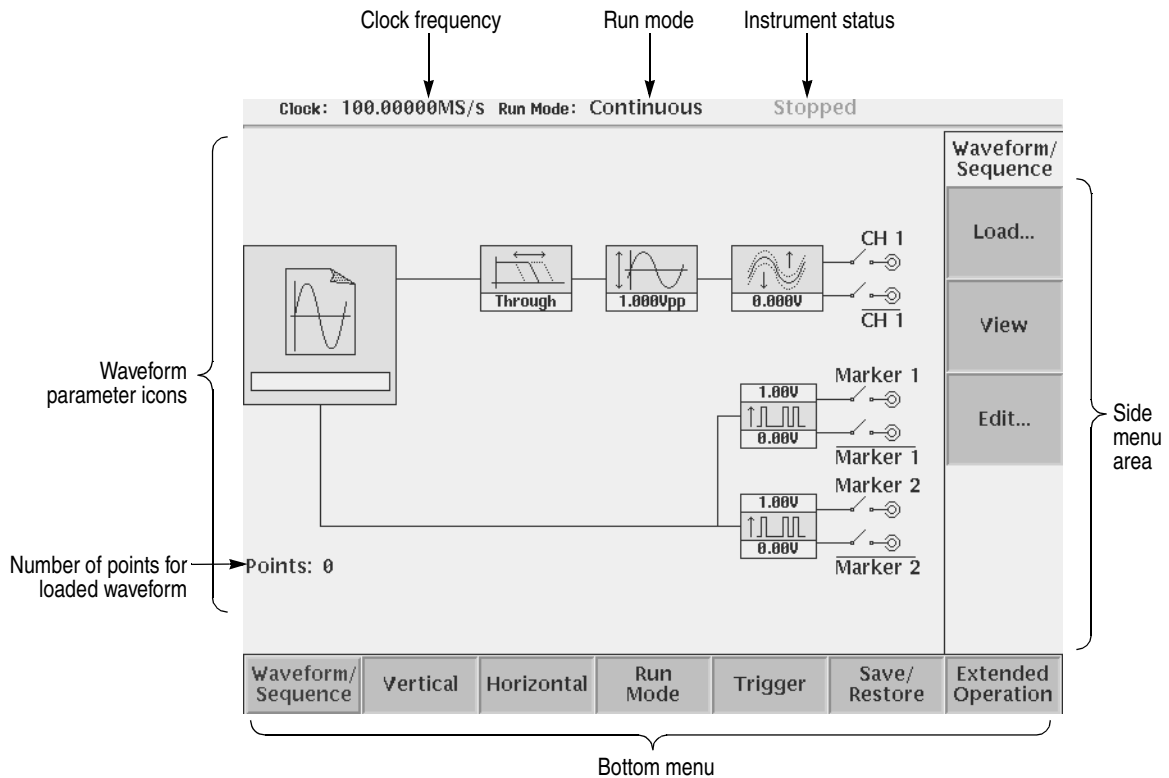

Figure 2-24: Main Setup screen (except option02)

Table 2-10: Setup screen parameter icons





Icon	Description	Icon	Description
	Displays the file name of the waveform, pattern, or sequence file loaded for output. Note: use the View button to display the loaded waveform.		Displays the digital output and marker signal minimum and maximum voltage settings.
	Displays the lowpass filter setting through which the waveform is passed. (except option 02)		Indicates that the channel output is enabled or disabled. If the switch is shown open, that channel output is disabled.
	Displays the peak-to-peak signal amplitude setting.		Indicates that the marker output is enabled or disabled. All Marker outputs are controlled by the ALL MARKER OUT ON/OFF button.
	Displays the signal offset setting. (except option 02)		

Table 2-11: Setup bottom menu buttons

Bottom menu button	Description
Waveform/Sequence	Displays the side menu for loading, viewing, editing waveform files, and for entering the FG mode main screen.
Vertical	Displays the Vertical side menu for setting waveform peak-to-peak amplitude, offset, lowpass filter, marker, and other output parameters. The product which has option 02 doesn't have offset and lowpass filter function.
Horizontal	Displays the Horizontal side menu for setting the clock source, clock frequency, and marker signal delay parameters.
Run Mode	Displays the Run Mode side menu for setting the instrument run mode. Refer to <i>Run Modes</i> in the <i>Reference</i> section for an explanation of the different run modes.
Trigger	Displays the Trigger side menu for setting trigger source, slope, level, external trigger impedance, and interval parameters.
Save/Restore	Displays the Save/Restore side menu to save and restore setup output parameters.
Extended Operation	Displays the Extended Operation side menu to change the operation mode such as FG mode, Waveform Mixing mode and Synchronous Operation (AWG710B only) mode.

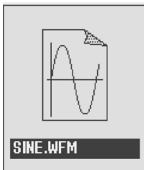
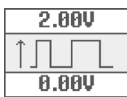
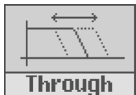
Loading a Waveform File to Output

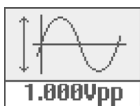
Do the following steps to load a waveform file into the Setup screen:

1. Push the **Waveform/Sequence** bottom menu button.
This opens the Waveform/Sequence side menu.
2. Push the **Load...** side button. The instrument opens the Select File list as shown in Figure 2-25.

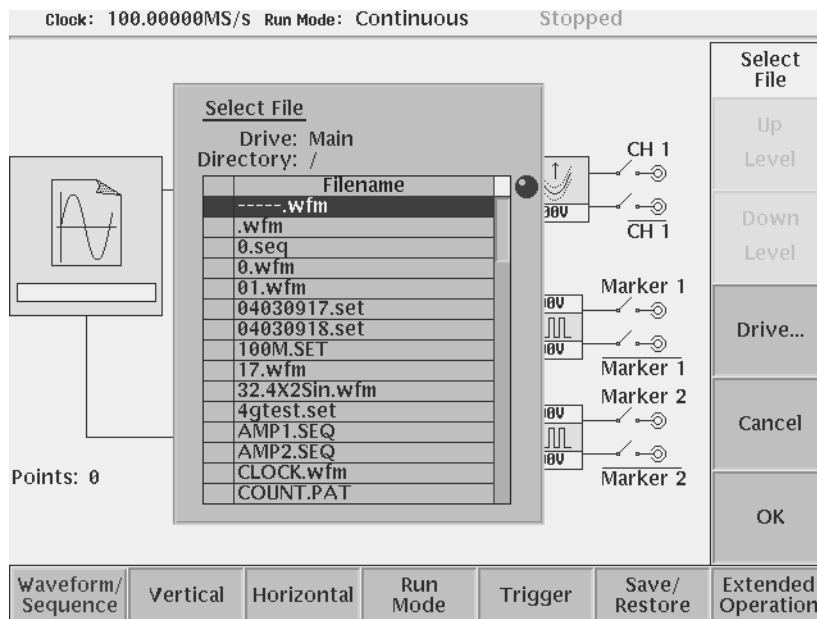

Figure 2-25: Select File dialog on the Load menu

3. Use the general purpose knob or ▲ and ▼ arrow buttons to select the file name to load. If the file you want to load is located in a different drive or directory, use the side menu buttons to change the current drive.
4. Push the **ENTER** front-panel button or **OK** side button. The instrument loads the file and displays the file name in the selected channel file icon. Push the **Cancel** side button to exit the file load process.

The procedures above explains how to load a waveform or pattern into the waveform memory, and/or sequence file into the sequence memory, which will be scanned to output. The waveform memory, sequence memory and the edit buffer are completely independent. So, you can edit a waveform, pattern, sequence or equation/text while outputting an another waveform or sequence.

However, when you push **SETUP** (front-panel)→**Waveform/Sequence** (bottom)→**Edit** (side) to copy the waveform in the waveform memory to the edit

buffer, you must save the currently edited waveform, pattern, sequence or equation/text into a file.

You can enter into the QUICK EDIT mode only from the waveform editor. When you enter into the quick edit mode, the instrument copies the data in the edit buffer into the undo buffer. All the changes you make immediately reflect to the data in the edit buffer, and also to the data in the waveform memory if that data is being loaded to output.

Before loading, you can view a waveform or pattern. Refer to *Quick View* on page 2-24 for more detail.

Viewing a Waveform

To view the loaded waveform file, push the **View** side menu button. The instrument opens a window on the screen that displays the waveform, as shown in Figure 2-26. Push the **OK** side menu button or **ENTER** front-panel button to close the view window.

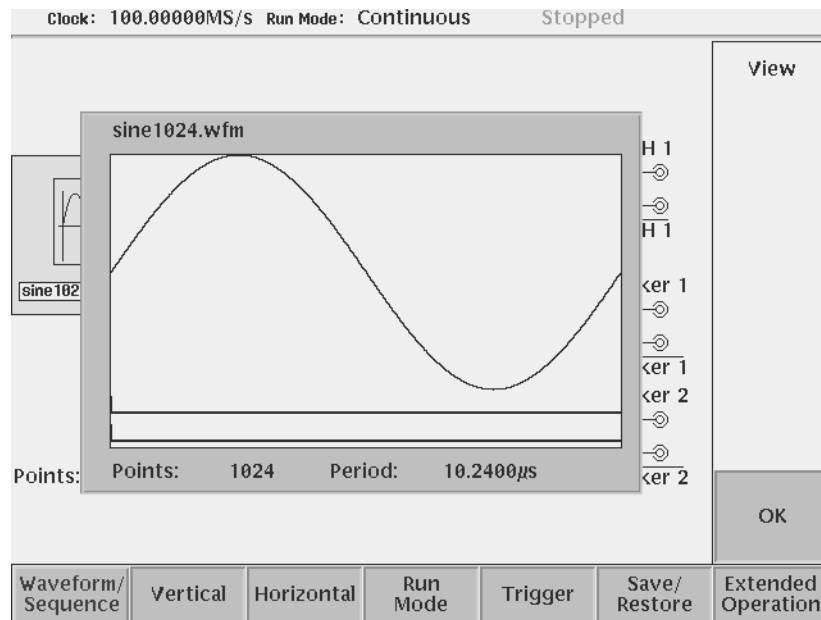

Figure 2-26: Viewing a file in the Setup screen

Note that the View function does not display the waveform in the waveform memory, but displays the waveform in the file that you specified. Even though you change the waveform with the editor and update the waveform memory, the View function still displays the waveform before the update unless you save the file.

Editing a Waveform

To edit the loaded waveform file, push the **Edit...** side menu button. The instrument opens the appropriate edit window for the previously loaded file type.

If you have not loaded a file in the Setup screen, the instrument displays the message *No output data*, and you cannot enter into the editor.

The editors are described in more detail in the *Reference* section beginning on page 3-55.

Setting Waveform Output Parameters

The Setup side menus provide commands for setting and adjusting waveform output parameters. The steps for setting output parameters are discussed in detail in the *Reference* section beginning on page 3-33. Table 2-12 provides an overview of the Setup side menu operations.

Table 2-12: Setup output parameter operations

Bottom button	Side button	Description
Waveform/Sequence	Load...	Displays the Select File dialog box that lists files in the current drive and directory. Select a file to load or use the side menu buttons to change drives and/or directories.
	View	Displays the loaded file in a window. Push the OK side menu button to close the view window.
	Edit...	Opens the appropriate editor for the loaded file.
Vertical	Filter	Selects lowpass filter to insert into signal path. Filter values are Through (no filter), 20 MHz, 50 MHz, 100 MHz, and 200 MHz. Use the general purpose knob to enter new values.(except option 02)
	Amplitude	Sets the signal peak-to-peak amplitude in increments of 0.001 V. The maximum value is 2 V _{p-p} in normal mode and 1 V _{p-p} in direct mode. Use the general purpose knob or the keypad to enter new values.
	Offset	Sets the signal offset value in increments of 0.001 V. The offset voltage range is ±0.5 V. Use the general purpose knob or the keypad to enter new values.(except option 02)
	Marker...	Displays a side menu to set Marker 1 and Marker 2 signal high and low values. The marker signal voltage range is -2.0 V to 2.45 V (-1.1 V to 3.0 V :AWG710) and maximum amplitude is 1.25 V _{p-p} into 50 Ω (2.5 V _{p-p} into 50 Ω : AΩΓ710). Use the general purpose knob or the keypad to enter new values.
	Output..	Toggles normal output to direct output.(except option 02)

Table 2-12: Setup output parameter operations (cont.)

Bottom button	Side button	Description
Horizontal	Clock	Sets the clock sample rate from 50 kS/s to 4.0 GS/s.
	Clock Ref	Sets the reference clock source to either Internal or External. A valid external clock signal is 10 MHz \pm 0.1 MHz with a voltage level of 0.2 to 3.0 V _{p-p} .
	Clock Src (AWG710B only)	Sets the clock source to either Internal or External. A valid external clock signal is 125 MHz to 4.2 GHz with a voltage level of 0.4 to 2.0 V _{p-p} .
Run Mode	Continuous Triggered Gated Enhanced	Displays the Run Mode side menu for setting the instrument run mode. Refer to <i>The Run Mode Menu</i> section on page 3-44 for an explanation of the different run modes.
Trigger	Source	Sets trigger source to Internal or External. If External selected, all other side menu items are not selectable except Interval.
	Slope (or Polarity)	Sets the trigger slope or gate polarity to Positive or Negative.
	Level	Sets the trigger signal level. The trigger level range is \pm 5.0 V in 0.1 V increments.
	Impedance	Sets the external trigger input line impedance to either 50 Ω or 1 k Ω .
	Interval	Sets trigger interval from 1.0 μ s to 10.0 s.
Save/Restore	Save Setup	Save the setup parameters set by SETUP window and Extended Operation mode window as a setup file.
	Restore Setup	Restore a setup file.
Extended Operation	FG...	Enters the FG mode for easy generate of standard functional waveform.
	Waveform Mixing...	Enter the Waveform Mixing mode.
	Sync Master... (AWG710B only)	Enter the Sync-Master of the Synchronous Operation mode.
	Sync Slave... (AWG710B only)	Enter the Sync-Slave of the Synchronous Operation mode.

Outputting a Waveform

To output a loaded waveform, push the **CH 1 OUT** and/or **CH 1 OUT** and/or **ALL MARKER OUTPUT ON/OFF** front-panel button(s), then the **RUN** front-panel button. The LEDs near each button light up to indicate they are enabled. The instrument outputs the waveform depending on the Run mode. You can turn either or both channel outputs and marker outputs on or off while the instrument is running by pushing the **CH 1 OUT** or **CH 1 OUT** or **ALL MARKER OUTPUT**

ON/OFF buttons. To stop the waveform output, push the **RUN** button so that the LED turns off.

Saving and Restoring Setup Parameters

The waveform or pattern file contains only the waveform and clock information. When you load a waveform or pattern file, the output signal will use the current instrument setup parameters.

To save you from doing a manual setup procedure each time you load a waveform, the AWG710&AWG710B Arbitrary Waveform Generator lets you save setup parameters into a setup file. You can then restore the saved settings for use with waveforms.

The setup parameters of the AWG mode and the Extended Operation mode are saved in a setup file. When a setup file is restored, settings in both AWG mode and Extended Operation mode will replace the contents of a setup file.

Do the following steps to save the current setup parameters:

1. Push **SETUP** (front)→**Save/Restore** (bottom)→**Save Setup** (side).

The Input Filename dialog box appears.

2. Enter a setup file name.

The setup file name must have the extension .set.

3. Push the **OK** side button.

The setup information is saved to the designated file.

Do the following steps to restore setup parameters from a file:

1. Select **SETUP** (front)→**Save/Restore** (bottom)→**Restore Setup** (side).

The message box displaying *Restoring setup destroys current settings.* appears. The instrument then opens the Select Setup Filename dialog box.

2. Enter or select the setup file name to load.

3. Push the **OK** side button to load the file and restore the setup parameters, or push the **Cancel** side button to exit the restore process without loading the setup file.

Theory of Operation

This section presents an overview of the AWG710&AWG710B Arbitrary Waveform Generator hardware, data structures, and operating modes.

Block Diagram

Figure 2-27 and Figure 2-28 show the main hardware blocks that make up the AWG710& AWG710B Arbitrary Waveform Generator.

CPU. The CPU controls the whole instrument using the GPIB interface, floppy disk connection, 100/10BASE-T Ethernet connection, user interface through the display screen and the front-panel, and so forth.

Clock Oscillator. You can select either the internal or external reference clock source by using the SETUP horizontal menu.

If you select the external source, the reference signal connected to the 10 MHz REF In connector on the rear panel will be used.

The internal clock is from the reference clock oscillator, which uses direct digital synthesis (DDS). Figure 2-27 shows the clock oscillator configuration.

Trigger Control. The Trigger Control block controls the Memory Address Control in the operation mode that you specified from the RUN MODE menu.

Waveform Memory and Shift Register. The Waveform Memory block has 8 bits for waveform data and 2 bits per channel for markers, thus a total length of 32.4 M /64.8 M (option 01) (16.2 M /32.4 M (option 01) :AWG710) points. You can set any value from 960 points to 32.4 M/64.8 M (option 01) (16.2 M /32.4 M (option 01) :AWG710) points for the length of waveform data. It must be in increments of 4.

The Shift Register block is used to provide waveform data from the DAC at a rate up to 4.2 GS/s (4.0 GS/s : AWG710).

RUN modes. Selecting a RUN mode from the SETUP menu causes one of the following to operate the AWG710&AWG710B Arbitrary Waveform Generator:

Table 2-13: Run modes

Modes	Descriptions
Continuous	Consecutively output regardless of existence of a trigger signal.
Triggered	The output signal is obtained only once when one of the following is input: <ul style="list-style-type: none"> ■ An external trigger signal from the rear panel's TRIG IN connector. ■ A trigger signal generated with the front-panel's FORCE TRIGGER button. ■ A trigger command from remote device.

Table 2-13: Run modes (cont.)

Modes	Descriptions
Gated	The waveform is output only while: <ul style="list-style-type: none"> ■ An external trigger signal from the rear panel's TRIG IN connector. ■ A gate signal through the front-panel's FORCE TRIGGER button is TRUE. ■ A control command such as trigger or event from remote device. (Except the Synchronous operation mode)
Enhanced	The waveform is obtained, in the order defined with the sequence, based on: <ul style="list-style-type: none"> ■ A trigger signal (for example, an external trigger signal from the rear panel's TRIG IN connector). ■ An event signal from the rear panel's EVENT IN connector. ■ An trigger signal from the front panel's FORCE TRIGGER button. ■ An event signal from the front panel's FORCE EVENT button. ■ A control command such as trigger, event or jump from remote device. (Except the Synchronous operation mode)

Extended operation. Selecting a Extended operation from the Extended Operation menu causes one of the following to operate the AWG710&AWG710B Arbitrary Waveform Generator:

Table 2-14: Extended operation

Modes	Descriptions
FG	Enter the FG mode for easy generate of a standard functional waveform.
Waveform Mixing	Create and output a mixed waveform. Waveform mixing generates the waveform which added the value for every point of two waveforms, A and B, at a rate of a mixing ratio.
Synchronous Operation (AWG710B only)	Synchronous Operation is a feature that outputs synchronized two channels of signal using two units of AWG710B. A word synchronous called here means that two units of the AWG710B operate with the same clock and that start and stop of output signals of two units are corresponding. In the Synchronous Operation mode, the Clock and the Trigger signals of two units are provided directly from the master unit. For other signals, the master controls the slave through a LAN.

Analog Circuit. The Analog Circuit block contains the Filter, Attenuator, Output Amplifier, Calibration and Offset Circuits. These circuits are used to process signals generated from the DAC. Option02 has Calibration Circuits only.

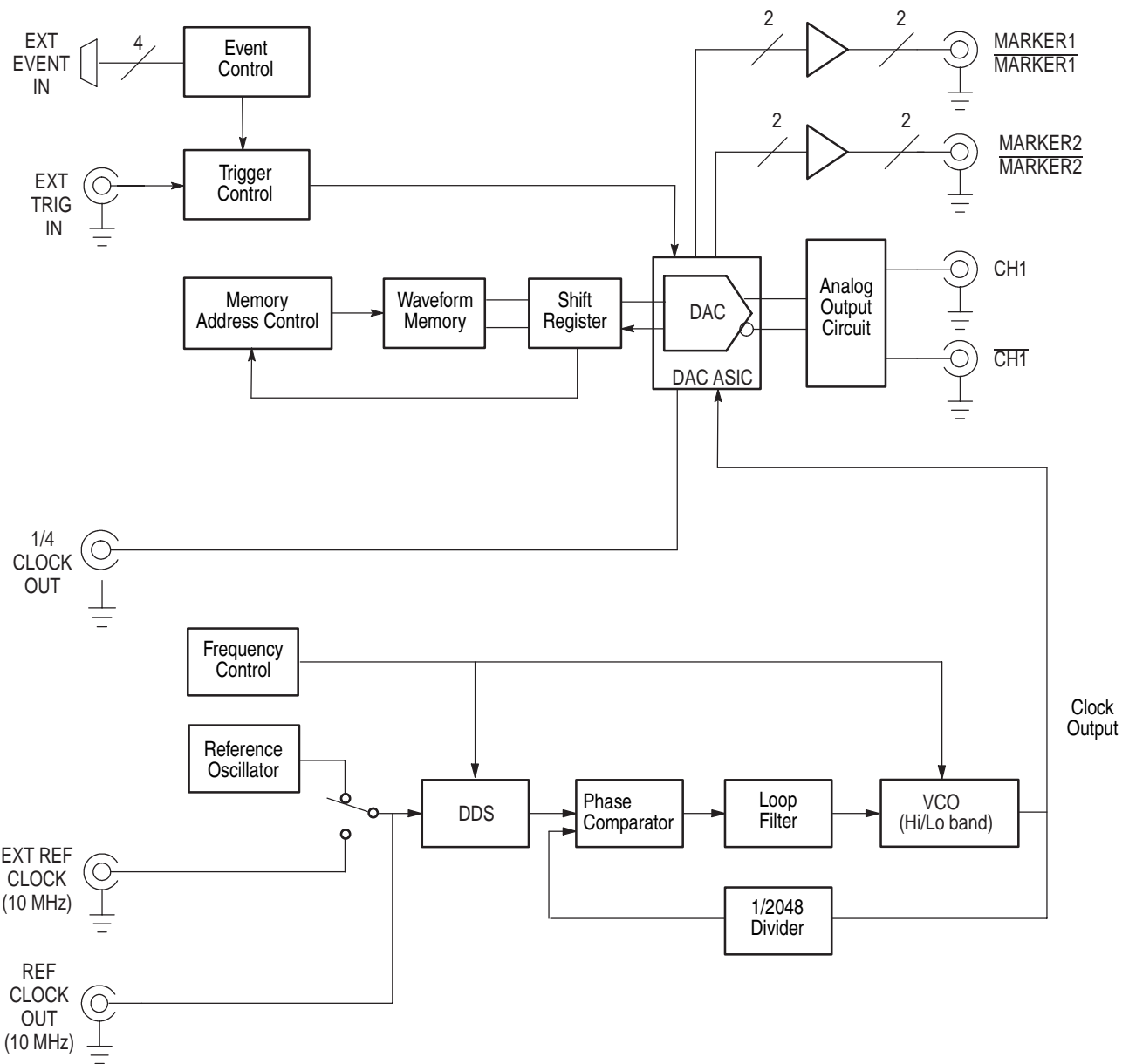

Figure 2-27: AWG710 block diagram

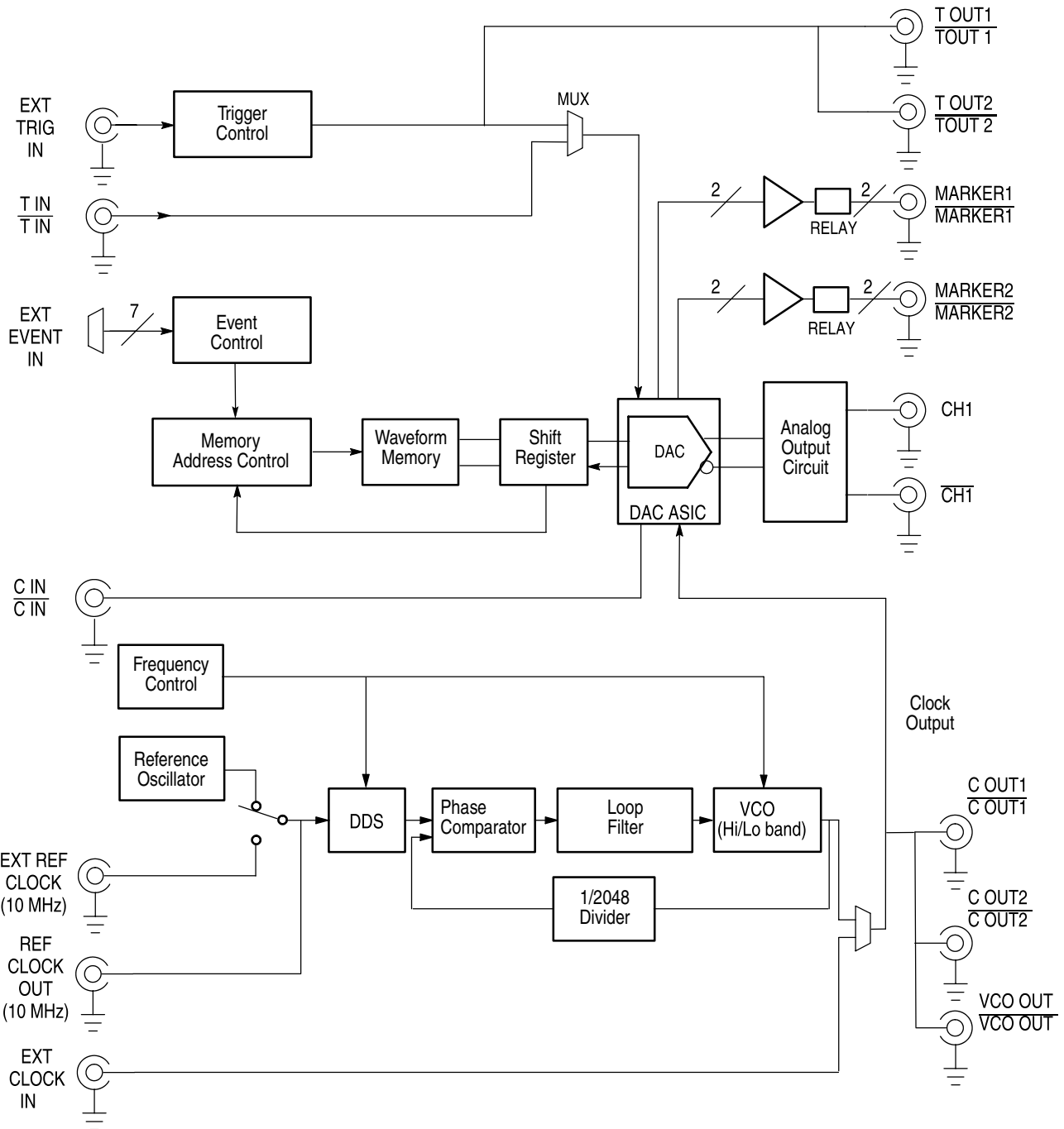

Figure 2-28: AWG710B block diagram

Memory Address Control. The Memory Address Control controls the addresses used to read waveform memory data.

This block loads the first address of the waveform into the Address Counter that was loaded into the waveform memory. It loads the waveform data length to the Length Counter. The Address Counter specifies the point from which the waveform was generated, and the Length Counter waveform ending position.

The Address and Length Counters operate with clocks produced by quarter frequency–division for the clocks from the clock oscillator.

If the repeat count value has been loaded in the Repeat Counter, the waveform is generated the specified number of times.

This block controls the sequence to the event signals generated in Enhanced Mode.

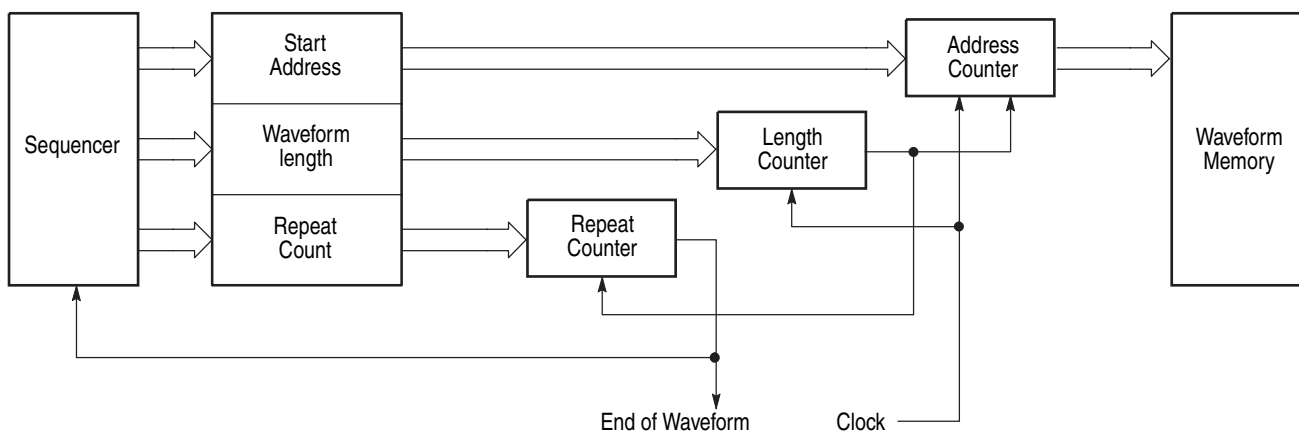

Figure 2-29: Relationship between memory address control and waveform memory

Figure 2-29 shows the relationship between the memory address control and the waveform memory.

Signal Edit Process

This subsection describes the signal edit process.

Load the desired waveform data to be output into the waveform memory. New waveform data can be created using waveform editors incorporated in the AWG710&AWG710B Arbitrary Waveform Generator. New data can also be created by combining the following:

- A sample waveform data distributed with floppy disks.
- Previously created waveform data on the built-in hard disk.
- Waveform data measured or created by other equipment, which has been read through the network.

Digital waveform data is loaded to the waveform memory location. The memory address control extracts the waveform data from memory, including the clock speed and the specified order of waveforms relative to the trigger event control.

When the AWG is in the Running mode, the digital output is processed through a high speed digital to analog converter (DAC). The output then goes through the analog output amplifier, to the offset and filter circuitry and to the output connector.

Waveform Data Structure

The waveform data structure consists of analog waveform and digital pattern file formats. The waveform file format includes 8-bits of resolution for the DAC output and 2-bits for the digital marker output. The pattern file format includes 10-bits for digital output (The AWG710&AWG710B supports 2 digital marker outputs). The full-scale resolution of the 8-bit DAC is represented by -1.0 to +1.0.

Waveform and pattern files use different internal formats and editors. The waveform file format is composed of 4-byte little endian and 1-byte for each data point and markers. The 4-bytes point data is expressed as an IEEE floating point number. The pattern data file is composed of 2-bytes including data and markers.

Waveform files contain floating-point numbers that maintain the mathematical data precision necessary for waveform math operations such as multiplying, dividing, adding, subtracting and so forth. Waveform files may be edited, but are much larger for an equivalent record length compared to pattern files.

Pattern files are most useful for minimizing file size and file transfer time between the AWG and a PC.

For more details about file format, refer to Data Transfer section in AWG710&AWG710B Arbitrary Waveform Generator Programmer Manual.

Waveform Edit To enable editing, the AWG710&AWG710B Arbitrary Waveform Generator provides you with Waveform, Pattern, Sequence, Equation, and Text Editors. See Table 2-15 for the explanations of those editors.

Table 2-15: Editors

Editors	Descriptions
Waveform Editor	<p>The Waveform Editor lets you create or edit a waveform that is being displayed on the screen. It enables you to create any waveform by an operation such as cut and paste, partial inversion about the horizontal or vertical axis, shift, or scaling. This operation can be based on a standard waveform, such as a sine or rectangular wave, or the previously created waveform.</p> <p>The Waveform Editor also has a unique feature that is capable of editing a waveform with waveform calculation functions (absolute value of waveform, differentiation/integration, convolution, correlation, addition/subtraction/multiplication between waveforms and so on).</p>
Pattern Editor	<p>The Pattern Editor displays a digital signal pattern with a pattern data placed in 8-bit creation waveform memory; it creates a digital signal pattern according to the High/Low settings you made for the individual bits.</p> <p>In addition to the functions supported by the Waveform Editor, the Pattern Editor is capable of generating frequently used digital signals unique to digital signals and pseudo random patterns.</p>
Sequence Editor	<p>The Sequence Editor lets you create a more complex waveform by combining a few types of the waveform data that you have created using Waveform and/or Pattern Editors. This editor also enables a Waveform listing jump and output stop to take place. They follow the external event information from the EVENT IN connector as well as the number of repetitions and the order for the individual pieces of waveform data.</p>
Text Editor	<p>The Text Editor creates an equation, more exactly, a waveform by a method of equations. When an equation has been created using this editor, you need to perform compiling.</p> <p>The Text Editor also enables you to edit a plain ASCII file. It should be used to edit ASCII-format waveform data created with another equipment as well as this instrument itself.</p>

Quick Edit The Quick Editor lets you modify and/or output any part of a waveform you are currently editing with the Waveform Editor. This is done in real time. The data between cursors can be scaled or shifted vertically and/or horizontally (Expand/Shift).

Tutorials

This section contains tutorials to help you learn how to operate the AWG710&AWG710B Arbitrary Waveform Generator. These tutorials provide a good introduction to the following basic features of the instrument:

- Setting up the instrument
- Loading and outputting a sample waveform
- Creating and editing standard function waveforms
- Editing a waveform using quick editor
- Using the equation editor
- Creating and executing sequences

NOTE. *These tutorials do not cover all the features and functions of the AWG710&AWG710B Arbitrary Waveform Generator. They are intended only to introduce the basic instrument functions.*

By connecting an oscilloscope to the AWG710&AWG710B Arbitrary Waveform Generator and observing the waveforms output, you will understand how the AWG710&AWG710B Arbitrary Waveform Generator works. The following equipment and accessories are needed:

- A digital storage oscilloscope
(A Tektronix TDS-Series oscilloscope or equivalent)
- One 50 Ω SMA cable
- One 50 Ω SMA terminator
- One SMA (Fe)–BNC (Ma) adapter

Connect the digital storage oscilloscope to the AWG710&AWG710B Arbitrary Waveform Generator as shown in Figure 2-30.

NOTE. *The \overline{CHI} LED is off when a signal is being output from CHI. If the \overline{CHI} LED is on, turn off the output by pushing the \overline{CHI} OUT button.*

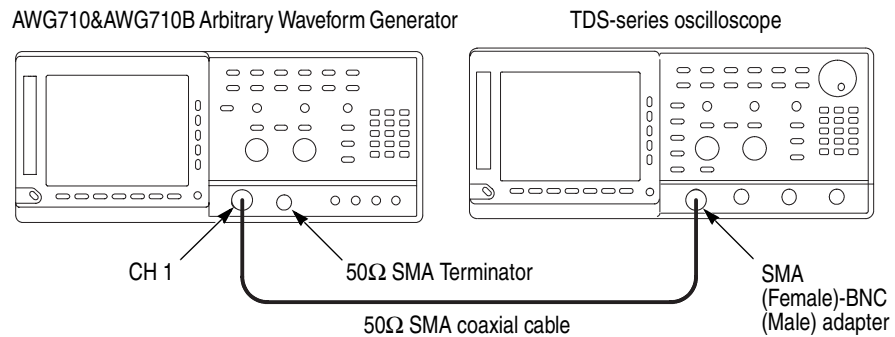

Figure 2-30: Cable connection between AWG710&AWG710B Arbitrary Waveform Generator and digital storage oscilloscope

Before beginning the tutorials, confirm that the instrument is installed correctly. Refer to *Installation* on page 1-9.

Push the **ON/STBY** button to power on the instrument. Refer to *Power On* on page 1-14. The startup diagnostic routines will run and the instrument displays an initial screen similar to that shown in Figure 2-31. You are now ready to perform the tutorials.

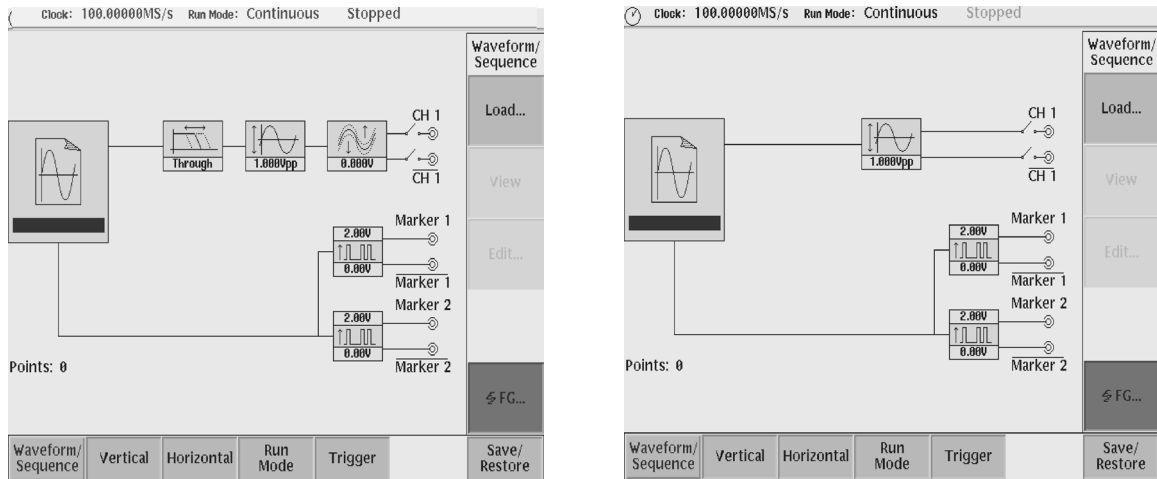

Figure 2-31: Initial screen (Right Figure: option02)

If the instrument does not power on correctly or does not pass the power-on diagnostics, contact the nearest Tektronix service center for help.

Tutorial 1: Instrument Setup

This tutorial shows you how to do some instrument setups.

In this tutorial you will learn the following:

- How to use the arrow button and general purpose knob
- How to set the date and time
- How to adjust the focused color

Display the UTILITY Menu

Do the following steps to display the system utility screen:

1. Press the **UTILITY** button on the front-panel to display the UTILITY menu.
2. Press the **System** bottom button (lower most-left button) on the bezel.

The instrument displays the system utility screen as shown in Figure 2-32.

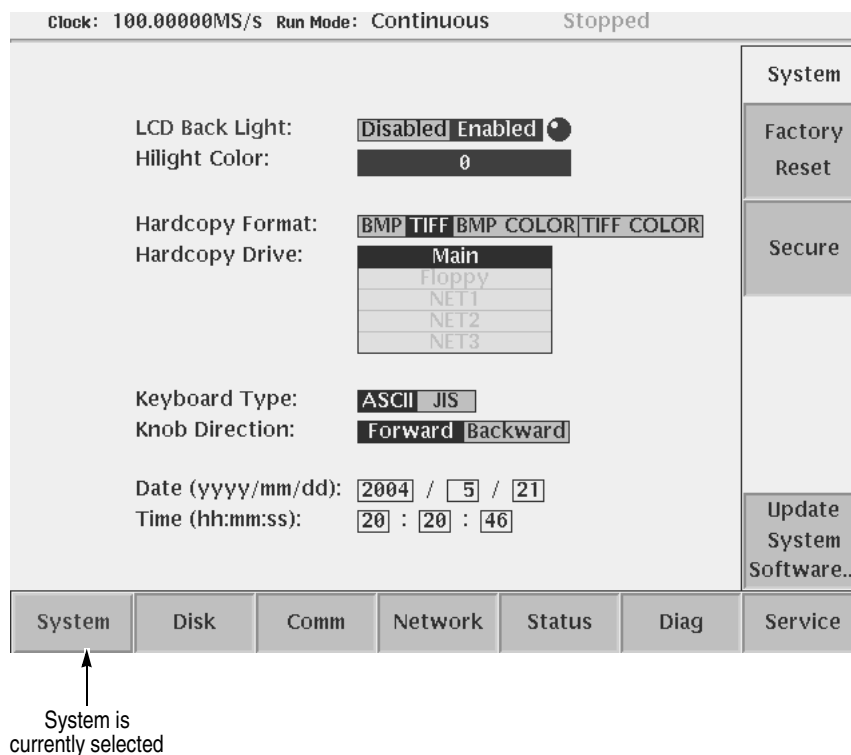



Figure 2-32: System utility screen



Set the Date and Time

Do the following steps to set the year:

1. Repeatedly press the  button in the upper middle part of the front panel until the Year: field is highlighted on the screen.
2. Turn the general purpose knob in the right upper corner of the front panel, clockwise or counterclockwise until the word *year* is displayed.

When using the general purpose knob, note that the current displayed year in the Year: field, is displayed in the upper right corner of the screen with the knob icon. This means that you can adjust the value using the general purpose knob.

Do the following steps to set the month and day:

1. Press the  button once to highlight the Month:.
2. Use the general purpose knob to set the month.
3. Set the date in the Day: as was done in step 1 and 2 above.
4. Using the  button and the general purpose knob, set the *hour*, *minute* and *second* in the Hour:, Min: and Sec:, respectively, as were done in step 1 above.

Set the Focused Color

Do the following steps to set the focused color:



1. Repeatedly press the  button until the Hilight Color: is selected.
2. Turn the general purpose knob clockwise or counterclockwise while looking at the screen until you get the color what you want.

The changes made during this tutorial take effect immediately. You can display the system utility screen and adjust the focused color at any time without exiting current tasks.

You have completed the Instrument Setup tutorial.

LCD Back Light

The default for the LCD back light is the on state.
Do the following steps to disable the LCD back light:

1. Repeatedly press the  button until the LCD Back Light is highlighted.
2. Press the  button or turn the general purpose knob to the left.

NOTE. The LED display state is saved when you turn the instrument off by pressing the ON / STBY button.

Do the following to turn on the instrument display:

1. Press the ON/STBY button to power on.
2. Press the **CLEAR MENU** button on the front-panel twice.

You have completed the Instrument Setup tutorial.

Tutorial 2: Loading and Outputting a Sample Waveform

This tutorial shows you how to load and output a waveform from the sample waveform floppy disk provided with the AWG710&AWG710B Arbitrary Waveform Generator.

In this tutorial you will learn the following:

- How to select a drive
- How to select and load a file
- How to view a loaded file
- How to output the loaded waveform file

Display the SETUP Menu

Do the following to display the SETUP menu:

Push the SETUP front-panel button to display the SETUP menu screen.

The **SETUP** menu screen is the initial power-on screen shown in Figure 2-31 on page 2-50.

Do the following to select a drive:

1. Insert the sample waveform floppy disk into the drive unit to the left of the screen.
2. Push the **Waveform/Sequence** bottom button to display the waveform/sequence side menu.

This side menu contains three items: **Load...**, **View**, and **Edit...**

NOTE. *The ellipsis (...) means that this menu item will display a submenu (side or pop-up) when selected.*

3. Push the **Load...** side button to display the Select File list, shown in Figure 2-33.

Make sure that the subside menu displays **Drive...**, **Cancel** and **OK** items.

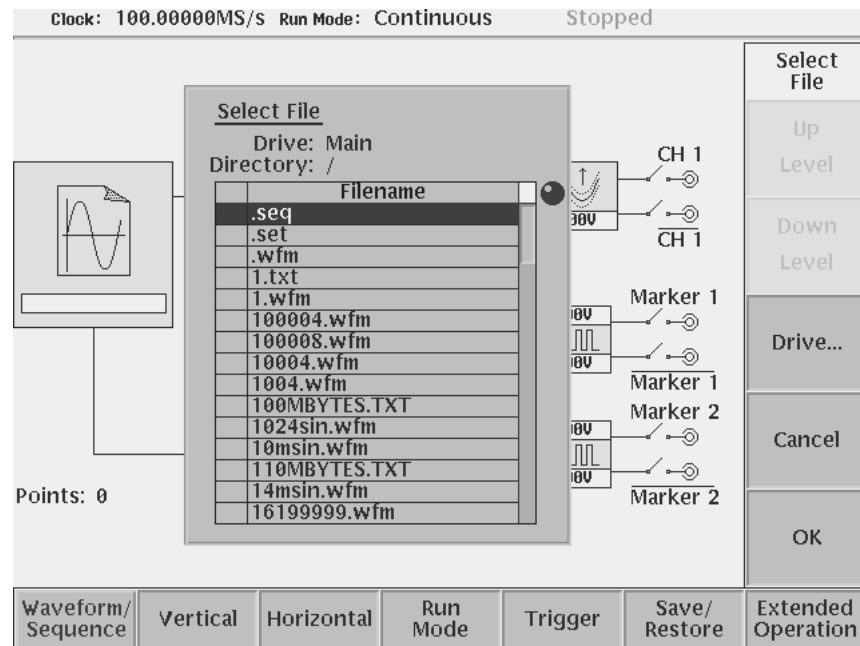

Figure 2-33: The Select File list

4. Push the **Drive...** side menu button.

The Select Drive dialog box appears at the corner of the screen and the Drive... side menu also appears. Note that the knob icon appears in the dialog box. This means that you can use the general purpose knob to select a drive from the list.

5. Turn the general purpose knob or use the navigation arrow buttons to highlight the word Floppy and then push the **OK** side button.

The dialog box now lists the files on the sample waveform floppy disk.

Load a Sample Waveform

Do the following steps to load a sample waveform:

1. Turn the general purpose knob to select *LIN_SWP.WFM* from the file listing in the dialog box.
2. Push the **OK** side menu button, and wait until the LED of the floppy disk drive goes off.

This operation loads the selected waveform file into the instrument waveform memory. Confirm that 8000 is displayed in the Points: display field at the lower left of the screen and that *LIN_SWP.WFM* is displayed in the WFM File: display field.

View the Sample Waveform

Do the following steps to view the waveform you just loaded:

1. Push the **View** side menu button to display the waveform.
The waveform is displayed on the screen as shown in Figure 2-34.
2. When you are done viewing the waveform, push the **OK** side menu button to exit the viewer.

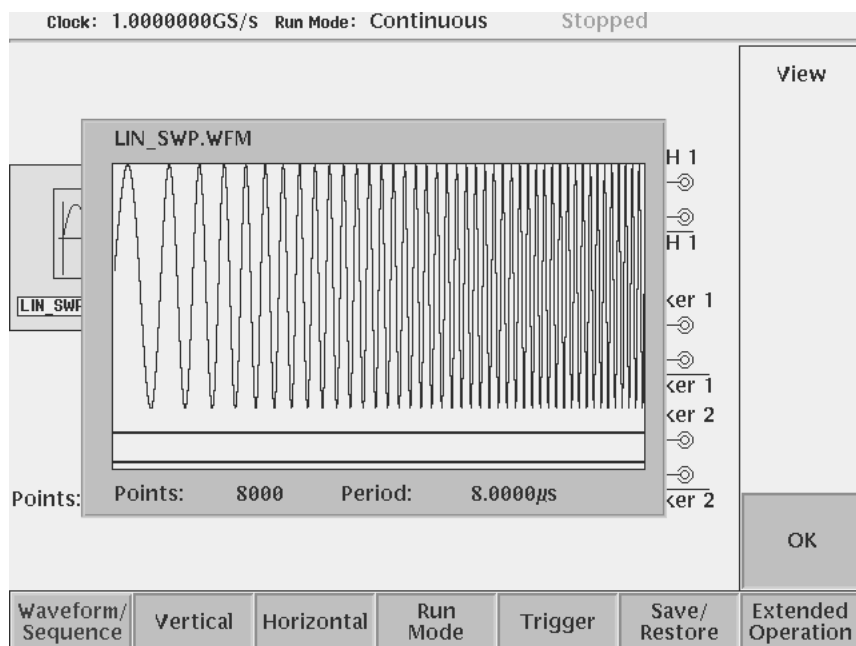

Figure 2-34: Viewing a waveform loaded into memory

Output the Waveform

Do the following steps to output the waveform from the CH1 output connector:

1. Push the **RUN** button on the front-panel.
Pushing the RUN button causes the instrument to output the analog waveform.
Push the **RUN** button again to stop the waveform output.

NOTE. You must push the RUN button to output a waveform. The instrument does not automatically output a signal after loading a data file unless the instrument was in the Run state when you loaded the new data file.

2. Push the **CH 1 OUTPUT** button near the CH1 output connector.
Pushing the CH 1 OUTPUT button connects the channel 1 output to the CH 1 connector. Push the **CH 1 OUTPUT** button again to turn off the CH1 output.
3. If you connected an oscilloscope to the Waveform Generator, observe that the waveform on the oscilloscope is the same as that shown in Figure 2-34.

You have completed the Loading and Outputting a Sample Waveform tutorial.

Tutorial 3: Creating and Editing Standard Function Waveforms

This tutorial shows you how to create a new waveform by combining two standard function waveforms in the waveform editor. You will create a sine wave and then multiply the sine waveform by another sine waveform.

In this tutorial you will learn the following:

- How to reset the instrument to factory defaults
- How to open the waveform editor
- How to create a standard function waveform
- How to do a waveform mathematical operation
- How to save and output the new waveform

Reset the Instrument

Do the following steps to reset the instrument to factory default settings:

1. Push the **UTILITY** button on the front-panel to display the **UTILITY** menu screen.
2. Push the **Factory Reset** side menu button.

The **SETUP** menu screen appears.

NOTE. If the **Factory Reset** side menu item is not shown, push the **System** bottom menu button, and then push the **Factory Reset** side menu button.

3. Push the **OK** side button. The instrument is reset to the factory default setting.

Open the Waveform Editor

Do the following steps to open the waveform editor screen:

1. Push the **EDIT** button on the front-panel.
2. Push the **Edit** bottom menu button.
3. Push the **New Waveform** side menu button.

The instrument displays the waveform editors initial screen as shown in Figure 2-35.

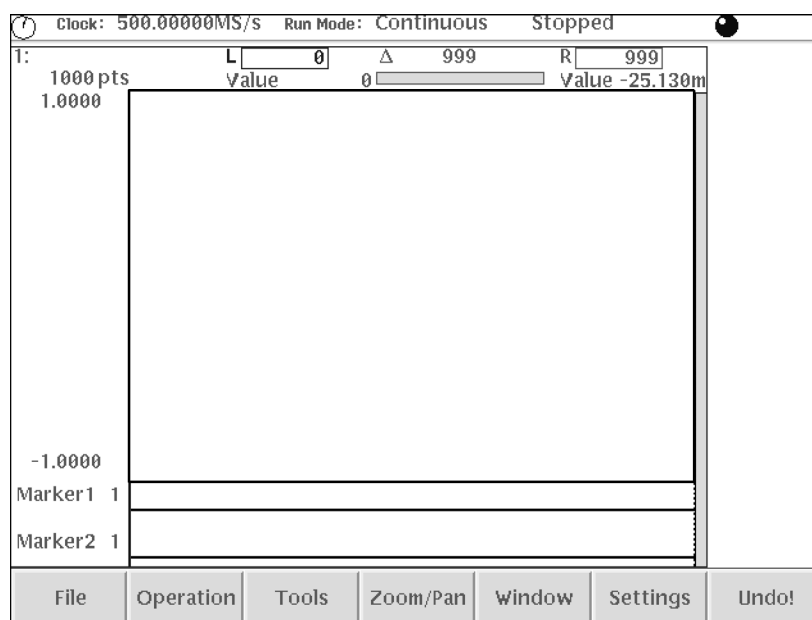

Figure 2-35: Waveform editor initial screen

Create a Sine Wave

Do the following steps to create a standard sine function waveform:

1. Push the **Operation** bottom button.
The instrument displays the Operation pop-up menu.
2. Select **Standard Waveform...** from the pop-up menu by using the general purpose knob.
By default, Standard Waveform... is selected.
3. Push the **OK** side button.
The instrument displays the standard function dialog box as shown in Figure 2-36.

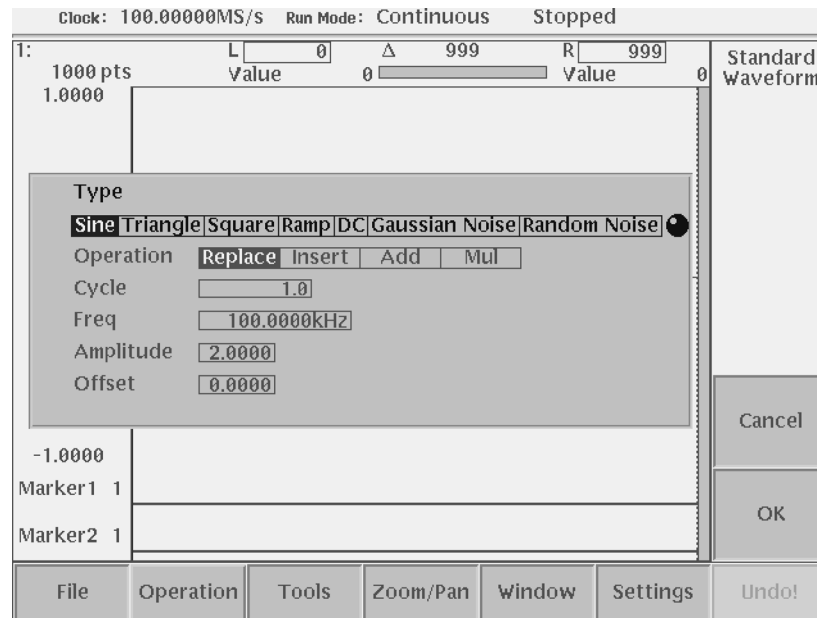

Figure 2-36: The Standard Function dialog box

4. Confirm that the knob icon is located to the right of the Type field items.
This is the default selection for this dialog box. If Type is not selected, use the ▲ or ▼ button on the front panel to select the Type field.
5. Turn the general purpose knob to highlight the **Sine** field item.
Note that Sine is the default selection.
6. Push the ▼ button twice to select the **Cycle** field.
7. Turn the general purpose knob to set the cycle to **5.0**.
8. Push the **Enter** button to enter the value in the field.
9. Push the **OK** side button.

You have created a five-cycle sine wave with a peak-to-peak range of 2.0 digital to analog converter (DAC) units, as shown in Figure 2-37.

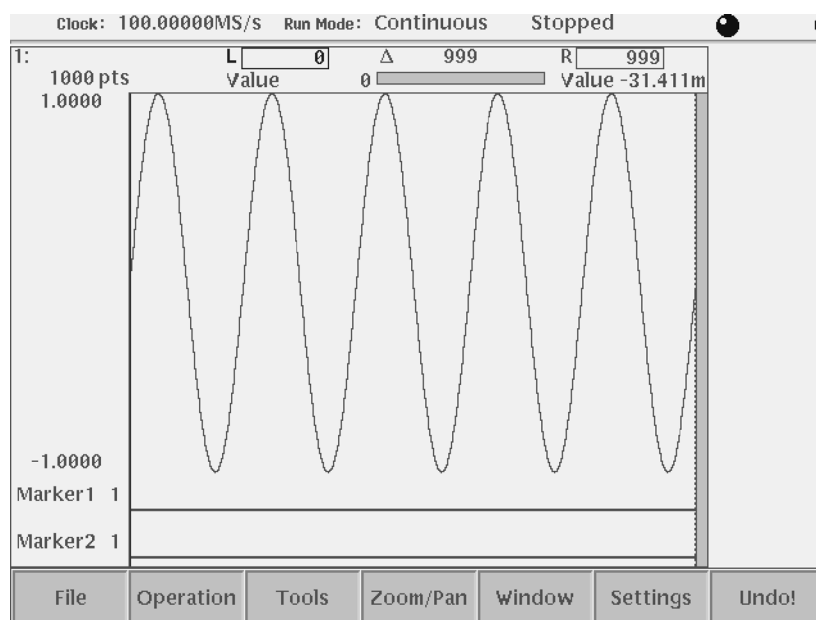

Figure 2-37: Standard sine wave function created in the Waveform Editor

NOTE. The waveform amplitude shown in the Waveform Editor does not directly correspond to the output waveform voltage amplitude. The levels in the Waveform Editor correspond to the instrument 8-bit digital-to-analog convertor (DAC) resolution. A signal with a -1.000 to +1.000 range utilizes the full resolution of the DAC circuit.

The actual output signal values (peak-to-peak and offset) are set in the Setup menu. The Setup menu output values are multipliers, and assume that the edited waveform signal uses the full ± 1.000 waveform range.

Math Operation

Do the following steps to create a new waveform by multiplying the current sine waveform with a second sine function waveform:

1. Push the **Operation** bottom button. The instrument displays the Operation pop-up menu.
2. Select **Standard Waveform...** from the pop-up menu by using the general purpose knob. By default, Standard Waveform... is selected.
3. Push the **OK** side button. The instrument displays the standard function dialog box as shown in Figure 2-36.
4. Turn the general purpose knob to highlight the **Sine** item in the Type field. Note that Sine is the default type menu selection.
5. Select **Operation** in the pop-up menu using the **▼** button.

6. Select **Mul** item using the general purpose knob.
7. Push the **▼** button once to select the **Cycle** field.
8. Use the general purpose knob to set the number of cycles to **20.0**.
9. Push the **▼** button twice to select the Amplitude field.
10. Use the general purpose knob to set the amplitude to **1.0**.
11. Push the **OK** side button to perform the multiply operation. This action multiplies the sine wave in the waveform editor by the sine wave you have specified in the Standard Function dialog box. Figure 2-38 shows the resulting waveform.

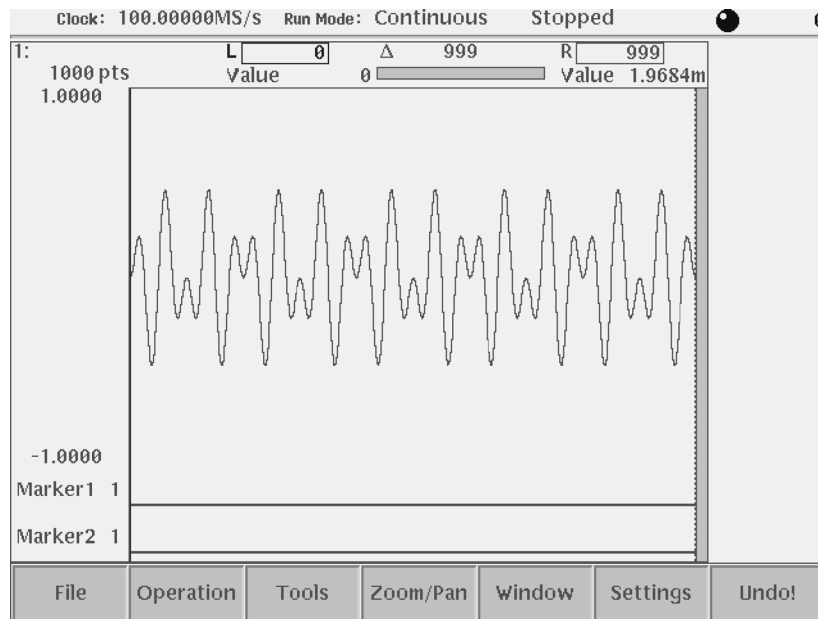

Figure 2-38: Waveform created with the multiply operation

Save the Waveform

Do the following steps to save the waveform:

NOTE. To output the waveform in the waveform editor, you must first save the waveform into a file and then load the file into the waveform memory.

1. Push the **File** bottom button.
The File pop-up menu appears.
2. Select **Save** from the pop-up menu using the general purpose knob.

3. Push the **OK** side button.

The Input Filename dialog box appears, as shown in Figure 2-39. Note that *.wfm* is displayed in the file name field.

4. Push the **SHIFT** button on the front-panel.

The SHIFT LED is on.

This operation lets you input uppercase characters with the keypad. The SHIFT LED goes off when the Input File Name dialog box disappears.

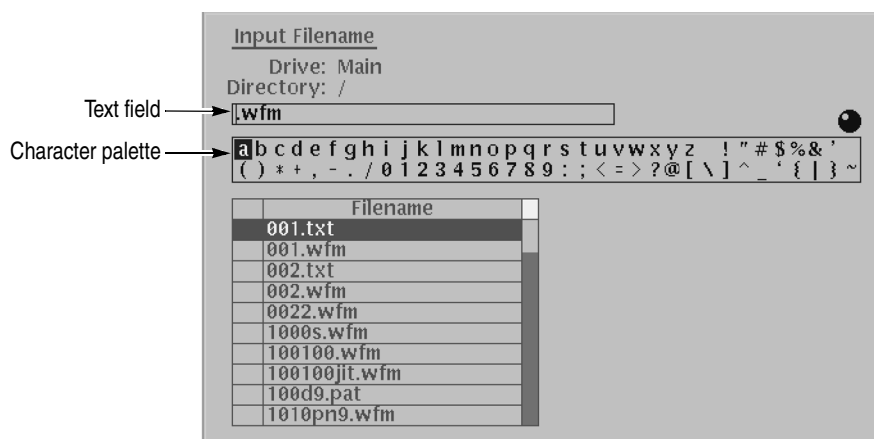

Figure 2-39: File Name Input dialog box

5. Push the **ENTER** button once.

Confirm that the letter A is inserted into the text field.

6. Turn the general purpose knob to highlight the letter B in the character palette, and push the **ENTER** button.
7. Turn the general purpose knob to highlight the letter C in the character palette, and push the **ENTER** button.
8. Push the **4** and **5** buttons on the front-panel keypad. Now, ABC45.wfm is displayed in the text field.
9. Push the **OK** side button.

The waveform in the editor is now saved in the file *ABC45.wfm*.

Output the Waveform

Do the following steps to load and output the saved waveform:

1. Push the **SETUP** button on the front panel to display the SETUP menu.
2. Load the file *ABC45.wfm*.

Refer to *Load a Sample Waveform* on page 2-54 if you need help.

3. Push the **RUN** button on the front panel to output the analog waveform.

NOTE. *Pushing the RUN button causes the instrument to output the waveform. Push the **RUN** button again to stop the output. The instrument does not automatically output the waveform from a newly-loaded file.*

4. Push the **CH 1** button near the CH 1 output connector on the front panel. If you connected an oscilloscope to the AWG710&AWG710B Arbitrary Waveform Generator, observe that the waveform on the oscilloscope is the same as the one you viewed in Figure 2-38.

You have completed the Creating and Editing Standard Function Waveforms tutorial.

Tutorial 4: Editing a Waveform Using Quick Editor

Quick editor is a function that lets you simultaneously edit and output a waveform. When you open the quick editor, the waveforms in the quick editor are completely independent of the waveform editor. When you exit from the quick editor, you can select whether to save or cancel the changes.

In this tutorial you will learn the following:

- How to enter into the quick editor
- How to edit a waveform
- How to save the changes in the waveform editor

Preparation Do the following steps to set the instrument to the factory default settings and load a sample waveform:

1. Reset the instrument to the factory default settings. Refer to page 2-56.
The SETUP menu screen appears.
2. Load the waveform *LIN_SWP.WFM* from the sample waveform floppy disk.
Refer to Tutorial 1 for how to load a waveform file from a floppy disk.

Open the Quick Editor Do the following to open the quick editor:

NOTE. You can enter the quick editor only from the waveform editor. First you open a file in the waveform editor, and then you enable the quick editor mode.

1. Push the **Edit...** side button for editing the waveform in the waveform editor.
The Waveform Editor screen appears, as shown in Figure 2-40.
2. Push the front-panel **QUICK EDIT** button.
When you enter into the Quick Editor, the bottom menu buttons are disabled and the Quick Editor side menu is displayed.

Edit a Waveform

You can only edit the waveform within the area between the two vertical cursors. You can move the active cursor (currently–selected vertical cursor) horizontally by turning the general purpose knob or by entering a numeric position with the front–panel keypad.

Select between the active cursors by pushing the **TOGGLE** front–panel button (located near the general purpose knob). The active cursor is represented by a solid vertical line, and the inactive cursor by a vertical dashed line.

The current cursor positions are displayed in the L and R fields in the upper part of the editor. By default, the left cursor is positioned in the left–most position of the editor screen. The right cursor is positioned in the right–most position of the editor screen.

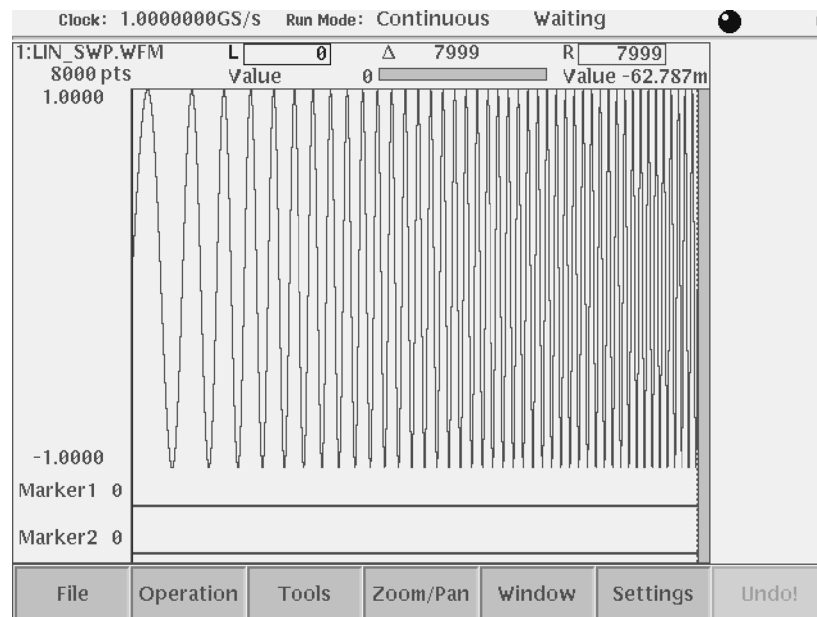

Figure 2-40: Waveform in the waveform editor

Do the following steps to specify the edit region (area between the cursors) using the cursors:

1. Confirm that the left cursor is active by checking the following:
 - The L field is highlighted.
 - The left cursor is a solid line.
 - The right cursor is a dashed line.

If the left cursor is not active, push the **TOGGLE** button on the front panel.

2. Move the left cursor to position 2808 by pushing the **2, 8, 0, 8,** and **ENTER** buttons.

If you have an external keyboard connected, just type the numbers and press the **Return** key.

3. Push the **TOGGLE** button on the front-panel to change the active cursor.
4. Confirm that the right cursor is now active by checking the following:
 - The R field is now highlighted.
 - The right cursor changed to a solid line.
 - The left cursor changed to a dashed line.
5. Move the right cursor to position 5461 by pushing the **5, 4, 6, 1,** and **ENTER** buttons.

If you have an external keyboard connected, just type the numbers and press the **Return** key.

Do the following to change the amplitude within the region specified by the area cursor:

Turn the **LEVEL/SCALE** knob clockwise to change the waveform amplitude to 0.5 V. The waveform should look like the one shown in Figure 2-41.

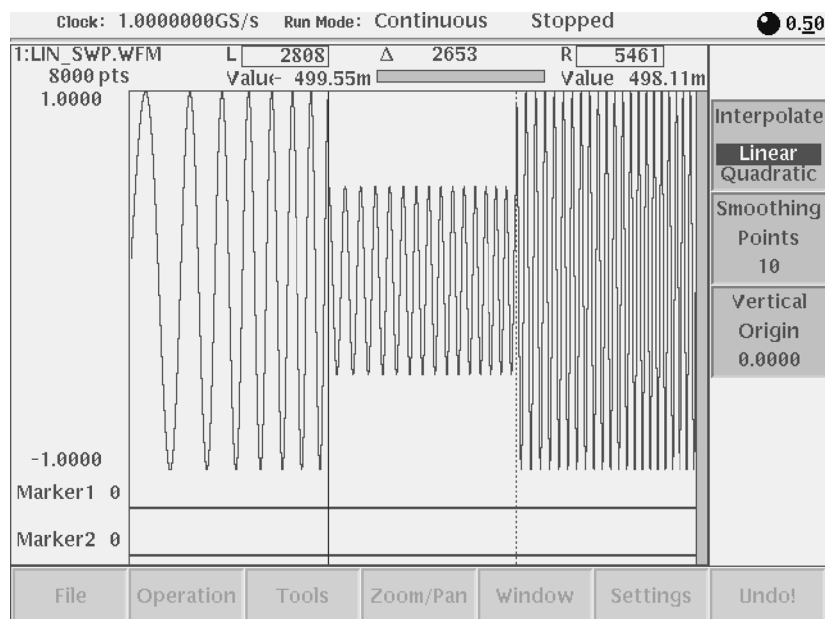

Figure 2-41: Waveform edit in quick editor

If you connected an oscilloscope to the AWG710&AWG710B Arbitrary Waveform Generator, observe that the waveform on the oscilloscope changes as soon as you make changes to the Quick Editor window.

Save Changes

The waveform in the edit buffer is copied into the Undo buffer before going into the Quick edit mode. Quick editing is performed on the waveform data in the edit buffer. When you quit the Quick Editor, you can save the changes or cancel the changes.

When you save the changes, the instrument does not take any action, as the waveform data is already current. When you select cancel the changes, the instrument copies the contents of the Undo buffer back to the edit buffer.

Do the following steps to save the Quick Edit mode changes you just made:

1. Push the **QUICK EDIT** button on the front panel to quit the quick editor.

A message box appears at the center of the screen and the side menu displays **Cancel**, **No**, and **Yes** menu items.

2. Push the **Yes** side button to save the changes.

If you have connected an oscilloscope to the AWG710&AWG710B Arbitrary Waveform Generator, the waveform being displayed on the oscilloscope screen shows the new waveform.

Remember that the waveform in the Quick Editor does not affect the waveform in the waveform memory unless you save it to the file.

You have completed the Editing a Waveform Using Quick Editor tutorial.

Tutorial 5: Using the Equation Editor

You can create a waveform by creating, compiling, and loading an equation file. An equation file is a text file that you create and edit in the equation editor.

In this tutorial you will learn the following:

- How to load an equation file
- How to edit an equation
- How to compile an equation file

Preparation Do the following steps to set the instrument to the factory default settings:

1. Push the **UTILITY** button on the front panel to display the UTILITY menu screen.
2. Push the **Factory Reset** side menu button.

The SETUP menu screen appears.

NOTE. If the *Factory Reset* side menu item is not shown, push the **System** bottom menu button and then push the **Factory Reset** side menu button.

3. Push the **OK** side button.

The instrument is reset to the factory default setting.

The SETUP menu screen appears.

NOTE. Connect a standard 101- or 106-key PC keyboard to the instrument to make it easier and faster to create and edit text.

Load an Equation File Do the following steps to load a sample equation file from the sample waveform floppy disk:

1. Insert the sample waveform floppy disk into the drive unit.
2. Push the **EDIT** button on the front panel.

The screen listing the files in the default storage media appears. If the screen does not show the file list, push the **EDIT** button again to display the file list.

3. Push the **Drive** bottom button.
4. Push the **Floppy** side button to select the floppy disk drive.

The file list for the floppy disk appears.

5. Select the file *LOG_SWP.EQU* from the file list using the general purpose knob.

6. Push the **EDIT** bottom button.
7. Push the **EDIT** side button.

The equation editor displays the *LOG_SWP.EQU* file.

Edit the Equation

Do the following steps to replace the `sin()` equation keyword with the `tri()` keyword:

1. Use the **▼** button to move the cursor downward and position it at the line where the sine function is written.
2. Use the **▶** button to move the cursor position to just after the word `sin`.
3. Push the **←** button three times in the keypad to delete the word `sin`.
4. Push the **Math Functions** bottom button to display the math functions pop-up menu.
5. Select **tri** from the pop-up menu using the general purpose knob.
6. Push the **OK** side button. Confirm that the word **tri** is inserted at the cursor position.

Save the Edited Equation

At compile time you cannot specify a storage drive. The instrument uses the drive specified when you loaded or saved the equation file. To compile the edited equation file to a hard disk file, you must first save the edited equation to the hard disk.

Do the following steps to save the edited equation to a hard disk file:

1. Push the **File** bottom button.
2. Push the **Save As...** side button.
The Storage Select dialog box is displayed on the screen.
3. Select **Main** from the dialog box using the general purpose knob.
4. Push the **OK** side button.
The Input File Name dialog box appears.
5. Push the **OK** side button.

This saves the equation file without changing the file name.

Compile the Equation

Do the following steps to compile the equation file:

1. Push the **Compile** side button.
When the compile completes, the waveform is saved into the file *log_swp.wfm*.
2. Push the **View** side button to view the compiled waveform, as shown in Figure 2-42.

3. Push the **OK** side button to close the viewer screen.
 4. Push the **Close** side button twice to exit the equation editor.
- You have completed the Using the Equation Editor tutorial.

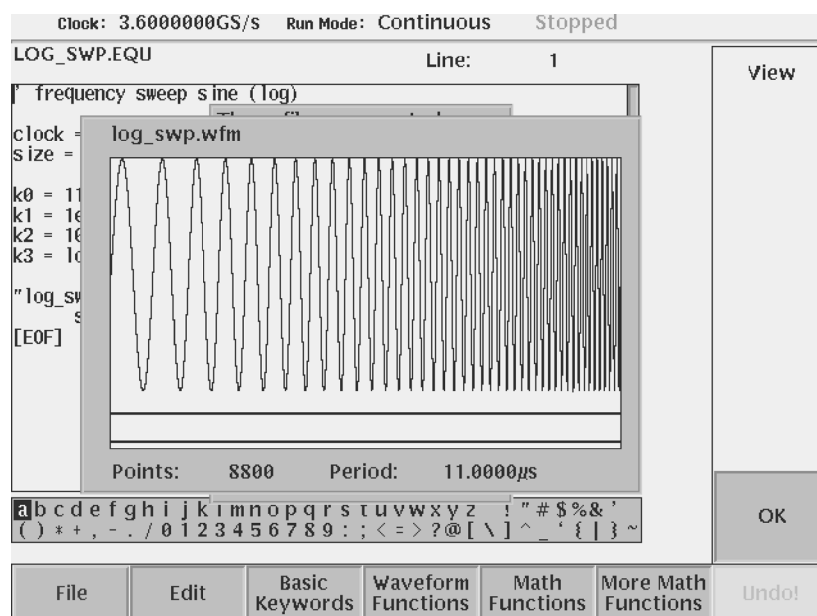

Figure 2-42: Viewer displaying compiled waveform

Tutorial 6: Creating and Running Waveform Sequences

The sequence editor lets you create a sequence file. A sequence file is a list of waveform or pattern files to output along with control statements that define how many times and when the waveform is output. This tutorial describes how to create five simple waveforms and two simple sequence files. The first sequence file is a main sequence file. The second sequence file is a subsequence called from the main sequence file.

In this tutorial you will learn the following:

- How to open the Sequence Editor
- How to edit a sequence table
- How to create a main sequence and a subsequence
- How to set run mode
- How to run the sequence

Preparation

Do the following steps to reset the instrument to the factory default settings:

1. Push the **UTILITY** button on the front-panel to display the **UTILITY** menu screen.
2. Push the **Factory Reset** side menu button.

If the **Factory Reset** side menu item is not shown, push the **System** bottom menu button, and then push the **Factory Reset** side menu button.

The **SETUP** menu screen appears.

3. Push the **OK** side button.

The instrument is reset to the factory default setting.

4. Push **EDIT** button on the front panel.

The screen lists the files in the current storage media.

NOTE. Push the **EDIT** button again to display a list of the files.

Creating Waveforms

You will create five waveforms using standard functions. Table 2-16 lists the waveforms you will create.

Table 2-16: Waveforms to be used in sample sequences

No.	Waveform file name	Standard waveform pop-up parameters				
		Type	Operation	Cycle	Amplitude	Offset
1	SINE.wfm	Sine	Replace	1.0	2.0	0.0
2	TRIANGLE.wfm	Triangle	Replace	1.0	2.0	0.0
3	SQUARE.wfm	Square	Replace	1.0	2.0	0.0
4	RAMP.wfm	Ramp	Replace	1.0	2.0	0.0
5	GAUSSN.wfm	Gaussian Noise	Replace	-	2.0	0.0

Do the following steps to create and save the sequence waveforms:

1. Follow the procedures in *Create a Sine Wave* on page 2-57.
In the Standard Function pop-up menu, use the parameters found in Table 2-16 for each waveform.
2. Follow the procedures in *Save the Waveform* on page 2-60.
In the Input File Name dialog box, input the waveform file name according to Table 2-16.

Figure 2-43 shows the screen displaying three windows. Each window contains one of the created waveforms. You can open and edit up to three waveforms at the same time. You may use this window function in the waveform editor for creating the above waveforms.

Do the following to select a window:

1. Push the **Window** bottom button.
2. Push the **Window 1**, **Window 2** or **Window 3** side button to activate that window.

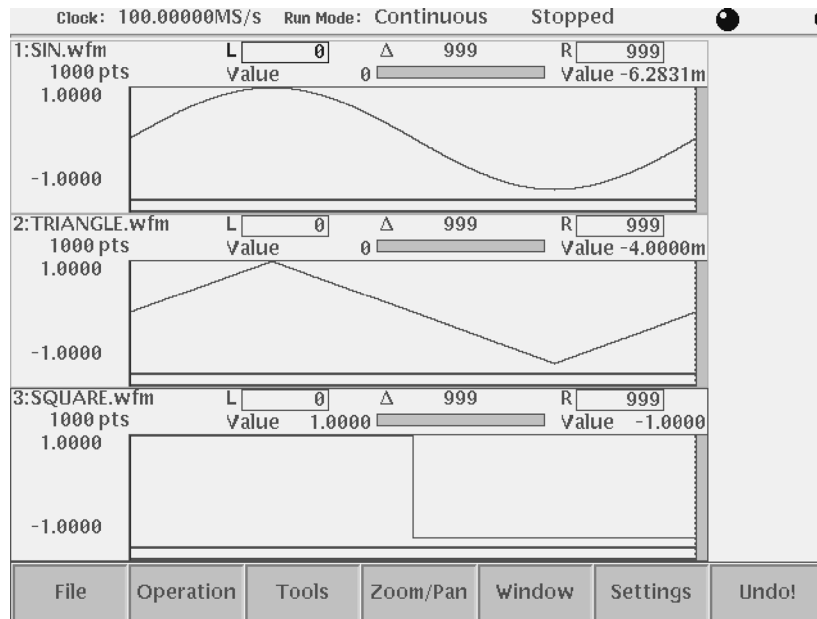

Figure 2-43: Waveforms created at the same time in three windows

Open the Sequence Editor

Do the following steps to open the sequence editor and create the sequences:





1. Push the **EDIT** button on the front panel.

Table 2-17: Sequence table contents in SUBSEQ.seq

Line	CH1	Repeat Count	Wait Trigger	Goto <N>	Logic Jump
1	GAUSSN.wfm	40,000			
2	RAMP.wfm	60,000			
3	TRIANGLE.wfm	60,000			
4	SINE.wfm	30,000			

In the sequence file used as subsequence, the Wait Trigger, Goto <N> and Logic Jump are neglected. They are effective only in the main sequence.

Do the following steps to create the subsequence:

1. Push the **Data Entry** bottom button.
2. Push the **Insert Line** side button.
This displays the line number in the Line column and allows you to edit the line.
3. Push the **Enter Filename...** side button.
The dialog box listing files appears at the center of the screen.
4. Select *GAUSSN.wfm* from the dialog box using the general purpose knob.
5. Push the **OK** side button.
The waveform file name *GAUSSN.wfm* appears in the CH1 column.
6. Push the  button once to move the highlighted cursor to the next line.
7. Repeat steps 2 through 6 to insert lines 2 through 4 and enter waveform file names listed in Table 2-17 into the CH1 column.
8. Repeatedly push the  button to go back to Line 1.
9. Push the  button to place the highlighted cursor on the Repeat Count column.
The side menu automatically changes and the Repeat Count side menu item appears. Note that the Repeat Count side menu item is selected by default.
10. Push the **4, 0, 0, 0, 0**, and **ENTER** buttons in this order.
The repeat count 40000 is set in the Repeat Count column.
11. Push the  button once to move the highlighted cursor to the next line.

Save the Subsequence

Do the following steps to save the subsequence table information to the file *SUBSEQ.seq*:

1. Push the **File** bottom button.
2. Push the **Save As...** side button.
The Input Filename dialog box appears.
3. Enter the file name *SUBSEQ.seq* into the file name field and save the file.
Refer to *Save the Waveform* on page 2-60 for more information.

Create the Main Sequence

In this procedure you will create the main sequence list shown in Table 2-18. The sequence list contains line numbers that relate to specific functions:

- **Line 1:** waits for trigger event. When a trigger event occurs, this line calls the subsequence file *SUBSEQ.seq* twice, and then goes to line 2.
- **Line 2:** infinitely outputs the ramp waveform until an event occurs. When an event occurs, the sequence jumps to line 3.
- **Line 3:** outputs the triangle waveform 40,000 times. When the output completes, the sequence goes back to the line 1. If an event occurs before this line completes execution, the sequence jumps to line 4.
- **Line 4:** outputs the sine waveform 60,000 times and then stops executing.

Table 2-18: Sequence table contents in MAINSEQ.seq

Line	CH1	Repeat Count	Wait Trigger	Goto <N>	Logic Jump
1	SUBSEQ.seq	2	On		
2	RAMP.wfm	Inf.			Next
3	TRIANGLE.wfm	40000		1	4
4	SINE.wfm	60000			

Do the following steps to create the main sequence:

1. Follow steps 1 and 2 in *Open the Sequence Editor* on page 2-72 to open a new sequence table.
2. Fill in the CH1 and Repeat Count columns for lines 1 through 4 according to Table 2-18.

Refer to steps 1 through 12 beginning on page 2-73 of this tutorial if you need help. To set *Inf.* in the Repeat Count of line 2, push the **Infinity** (SHIFT + ◀) side button once.

3. Repeatedly push the ▲ button to go back to the Line 1.

2. Push the **Event Jump** bottom button. The screen as shown in Figure 2-47 appears.

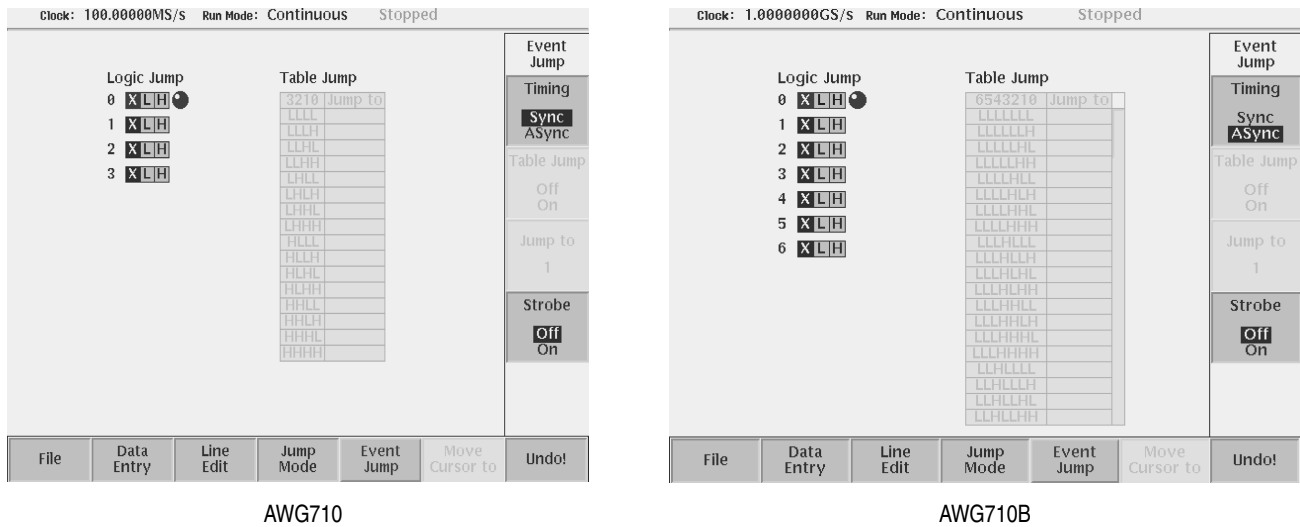

Figure 2-47: Screen for setting event jump

1. Push the **Timing** side button to set the timing to Sync.
2. Push the **Data Entry** bottom button to go back to the sequence table screen.
3. Push the \blacktriangledown button once and then \blacktriangleright button twice to move the highlighted cursor to the Logic Jump column.
4. Push the **Jump to Next** side button.
5. Push the \blacktriangledown button once to go to the next line.
6. Push the **Jump to Specified Line** side button.
7. Push the **Jump to** side button, and set **4** using the general purpose knob.
8. Push the **CLEAR MENU** bottom button to move the highlighted cursor right and left by using the \blacktriangleleft and \blacktriangleright buttons.
9. Push the \blacktriangleleft button once to move the highlighted cursor to the Goto <N> column.
10. Push the **Data Entry** bottom button to go back to the sequence table screen.

11. **Go to Next** and **Go to Specified Line** menu items appear on the side menu (see Figure 2-48).

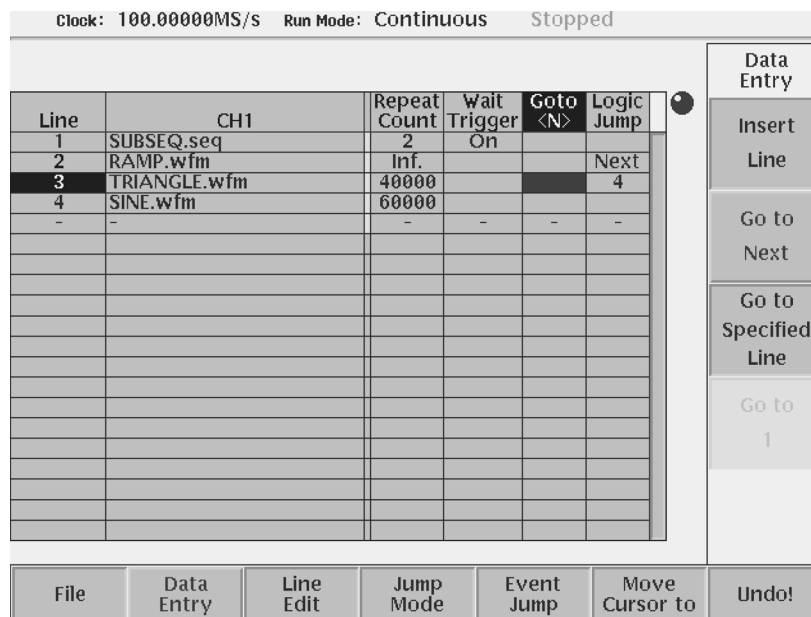

Figure 2-48: Setup of Goto <N>

12. Push the **Go to Specified Line** side button and the **Go to n** side menu item appears. Enter the number (1 to 8000) by using the general purpose knob or the numeric keypad.

This completes the main sequence table editing. The main sequence table should look like Figure 2-49.

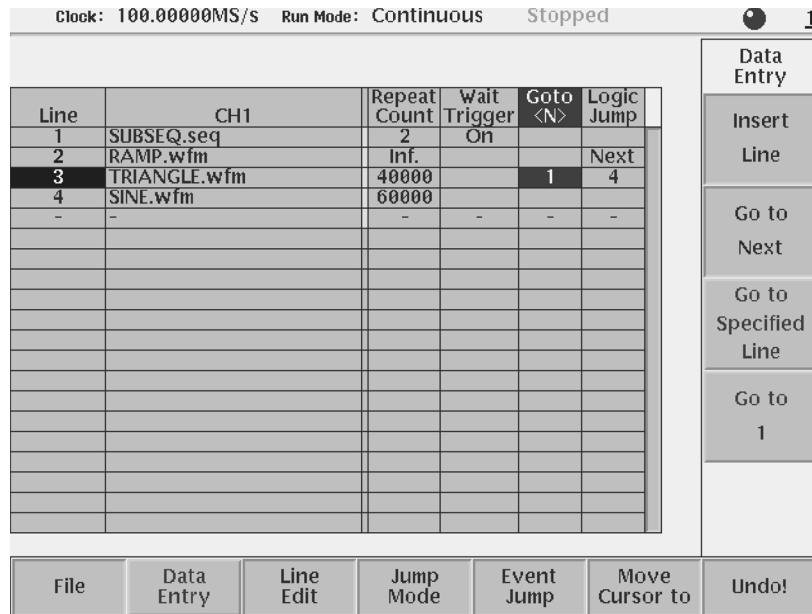

Figure 2-49: Example of sequence (MAINSEQ.seq)

23. Save the sequence table in the file *MAINSEQ.seq*. Refer to *Save the Sequence* on page 2-76.

Set Run Mode

The event jump functions in the sequence list are only functional when the instrument run mode is set to Enhanced mode. Do the following steps to set the run mode to enhanced:

1. Push the **SETUP** button on the front-panel to display the SETUP screen.
2. Push the **Run Mode** bottom button.
3. Push the **Enhanced** side button.

Load and Run the Sequence Files

Do the following steps to load and run the sequence files:

1. Push the **Waveform/Sequence** bottom button.
2. Push the **Load...** side button.
3. Select *MAINSEQ.seq* from the file list in the dialog box.
4. Push the **OK** side button.

If there is an error in the sequence descriptions, the instrument displays a message and stops reading the files. Errors may occur when you use infinite repeats in a subsequence.

NOTE. The AWG710&AWG710B Arbitrary Waveform Generator reads all related sequence files and waveform files at this time. If the instrument cannot read or find a sequence file, it displays an error message. Make sure that you entered the sequence and subsequence file names exactly as they appear in the file lists. Remember that file names are not case sensitive.

Run the Sequence Files

Do the following steps to load and run the sequence files:

1. Push the **RUN** button.
The RUN LED is on.
2. Push the **CH 1 OUT** button near the CH1 connector.
The CH1 LED is on.

When the subsequence *SUBSEQ.seq* is recalled, the AWG710&AWG710B Arbitrary Waveform Generator waits for a trigger event. The message Waiting is displayed in the current run status area when the instrument is waiting for a trigger. The instrument is waiting because line 1 of the main sequence is waiting for a trigger before outputting the waveforms on that line.

NOTE. The instrument has a function that automatically provides trigger signals at user-defined intervals. If the instrument does not wait for you to press the Force Trigger button before executing the sequence table, you will need to disable the automatic trigger signal. Refer to page 3-47 for information on how to disable automatic trigger signals.

3. Push the **FORCE TRIGGER** button on the front panel to generate a trigger event.

Line 1 of *MAINSEQ.seq* calls the subsequence file as soon as it detects a trigger event. The subsequence list outputs the four waveforms and then returns to line 2 of the main sequence.

Line 2 continuously outputs the ramp waveform while waiting for an event signal. You will supply an event signal in the next step.
4. Push the **FORCE EVENT** button on the front panel.

This causes the sequence to jump to line 3. When line 3 completes output of the triangle waveform, it goes back to the line 1 and starts the output process over again. So, line 1 to 3 loops and the main sequence file does not terminate unless you push the **FORCE EVENT** button.

You have completed the *Creating and Running Waveform Sequences* tutorial.

Refer to the *Reference* section beginning on page 3-1 for detailed information on all instrument functions.



Reference

Reference

This section provides the following information:

- Editor operations overview
- Menu structures shows the tree structuring each menu
- Functions and procedures for instrument setup, including horizontal and vertical axis parameters, run mode, trigger setup, markers, and file handling
- Functions and procedures for using the waveform, pattern, sequence, and equation/text editors
- Functions and procedures for using applications and utilities

Overview

Process Flow Figure 3-1 shows a typical process flow from creating and editing to outputting.

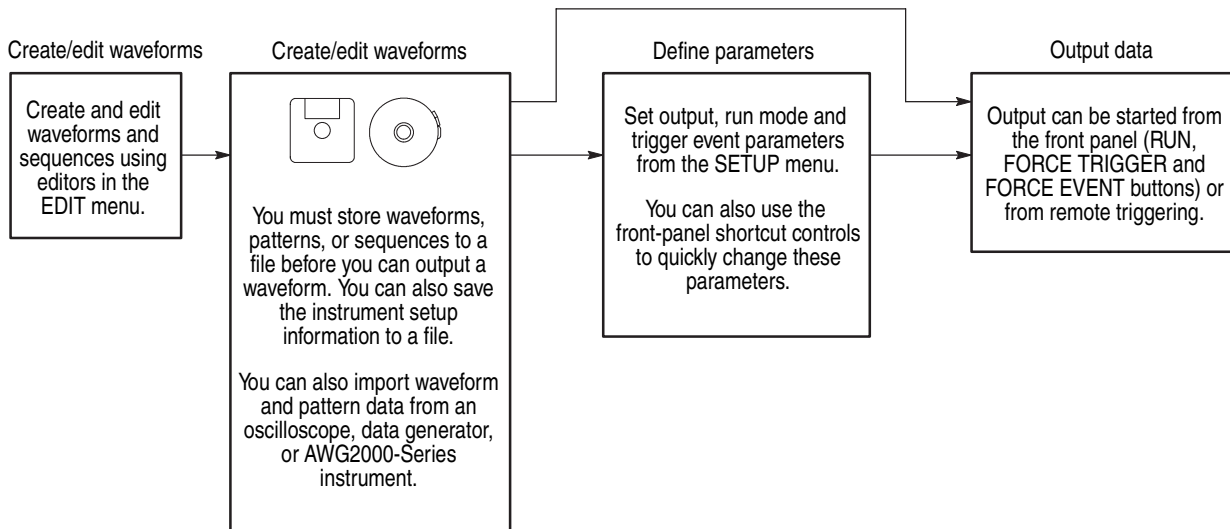

Figure 3-1: Overview of AWG710&AWG710B Arbitrary Waveform Generator process flow

Menus Table 3-1 lists the four main menus in the AWG710&AWG710B Arbitrary Waveform Generator. Additional menu information can be found in the Reference section of this manual beginning on page 3-3.

Table 3-1: AWG710&AWG710B Arbitrary Waveform Generator main menus

Menu button	Description
SETUP	Controls waveform output settings including trigger source and sample clock rate.
EDIT	Controls access to all functions for creating, editing, converting, importing and exporting waveforms. Quick Editor functions are accessed through the Waveform editor. You can enter into the Quick Editor only from the waveform editor.
APPL	Creates signals for testing devices such as hard disks, networks, and also for jitter testing.
UTILITY	Controls instrument setup functions that are not directly related to editing or output.

Menu Structures

This section describes the structures for the menu system. The four main menu structures contain the following submenus:

- Bottom menus
- Side menus
- Pop-up menus

Item labels that follow the ellipsis (...) bring up either a subside menu, pop-up menu, or a dialog box.

The side menus are illustrated as follows:

- Side menu items that switch between two parameters:

Format: Item-label {param1 | param2}

Example: Output {Normal | Direct}

- Side menu items that allow the selection with the general purpose knob:

Format: Item-label {option1 | option2 | option3 | ...}

Example: Filter {20 MHz | 50 MHz | 100 MHz | 200 MHz | Through}

- Side menu items that allow numeric values to be set using the numeric keys or the general purpose knob:

Format: Item-label (minimum to maximum)

Example: Level (-5.0 to 5.0 V)

The access lines to the pop-up menu or screen menu items are represented with a dashed line.

Setup Menu Hierarchy

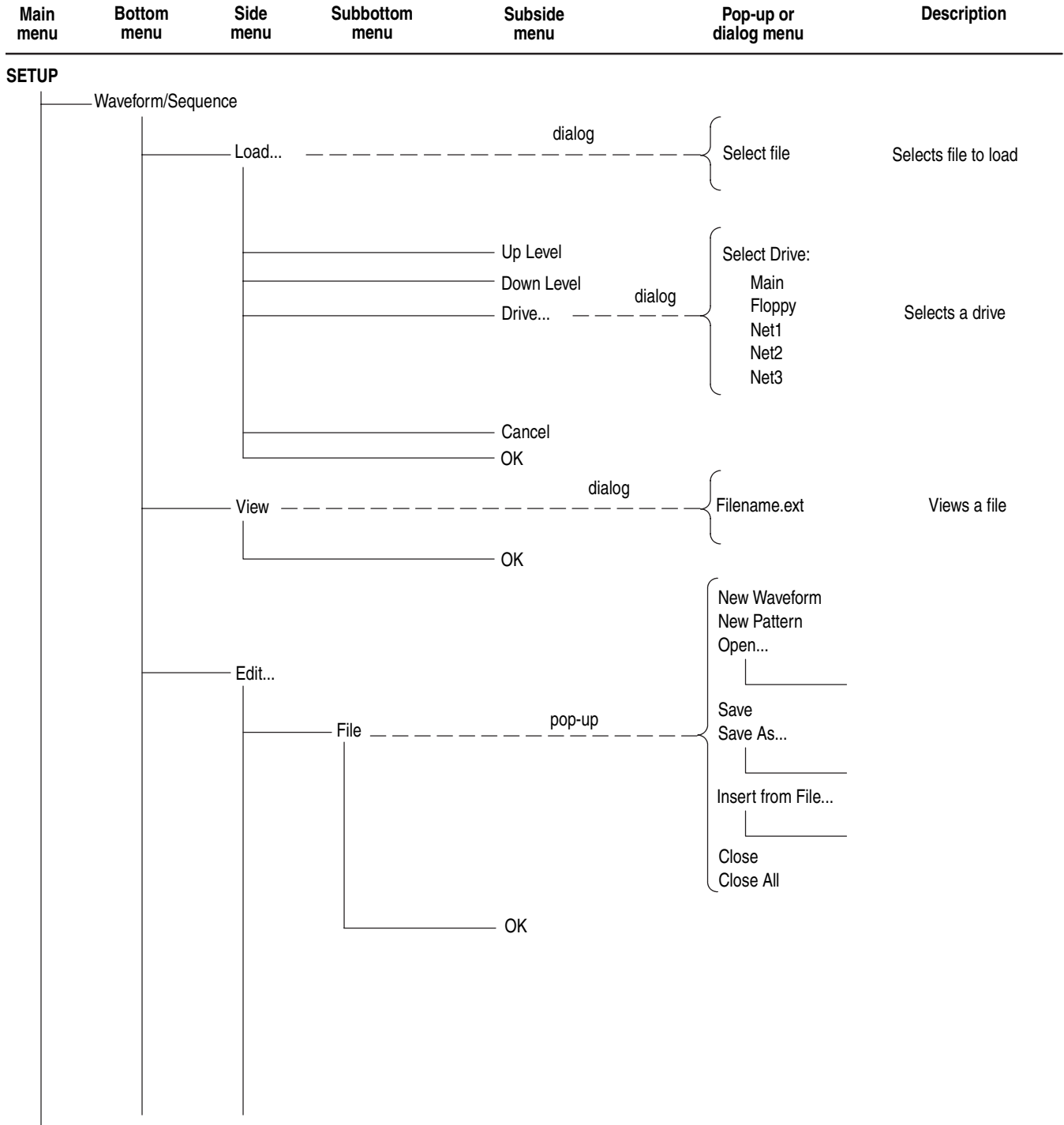

Main menu	Bottom menu	Side menu	Subbottom menu	Subside menu	Pop-up or dialog menu	Description
SETUP (cont.)	Waveform/Sequence (cont.)				Standard Waveform...	Edit commands
		Edit... (cont.)			Select Lines	
			Operation		Cut	
					Copy	
					Paste (Insert)	
					Paste (Replace)	
					Multiple Paste...	
					Set Data High/Low...	
					Counter...	
					Horizontal Shift...	
				pop-up	Horizontal Rotate...	
					Vertical Shift...	
					Expand...	
					Vertical Scale...	
					Horizontal Invert...	
					Vertical Invert...	
					Clip...	
					Shift Register Generator...	
					Set Pattern.....	
				OK	Numeric Input...	

Menu Structures

Main menu	Bottom menu	Side menu	Subbottom menu	Subside menu	Pop-up or dialog menu	Description
SETUP (cont.)						Edit commands
	Waveform/Sequence (cont.)					
		Edit... (cont.)				
			Tools			
					pop-up	
						Absolute Square Cube Square Root Normalize Differential Integral Add Sub Mul Compare... Convolution... Correlation... Digital Filter... Re-Sampling Code Convert... XY View...
						OK

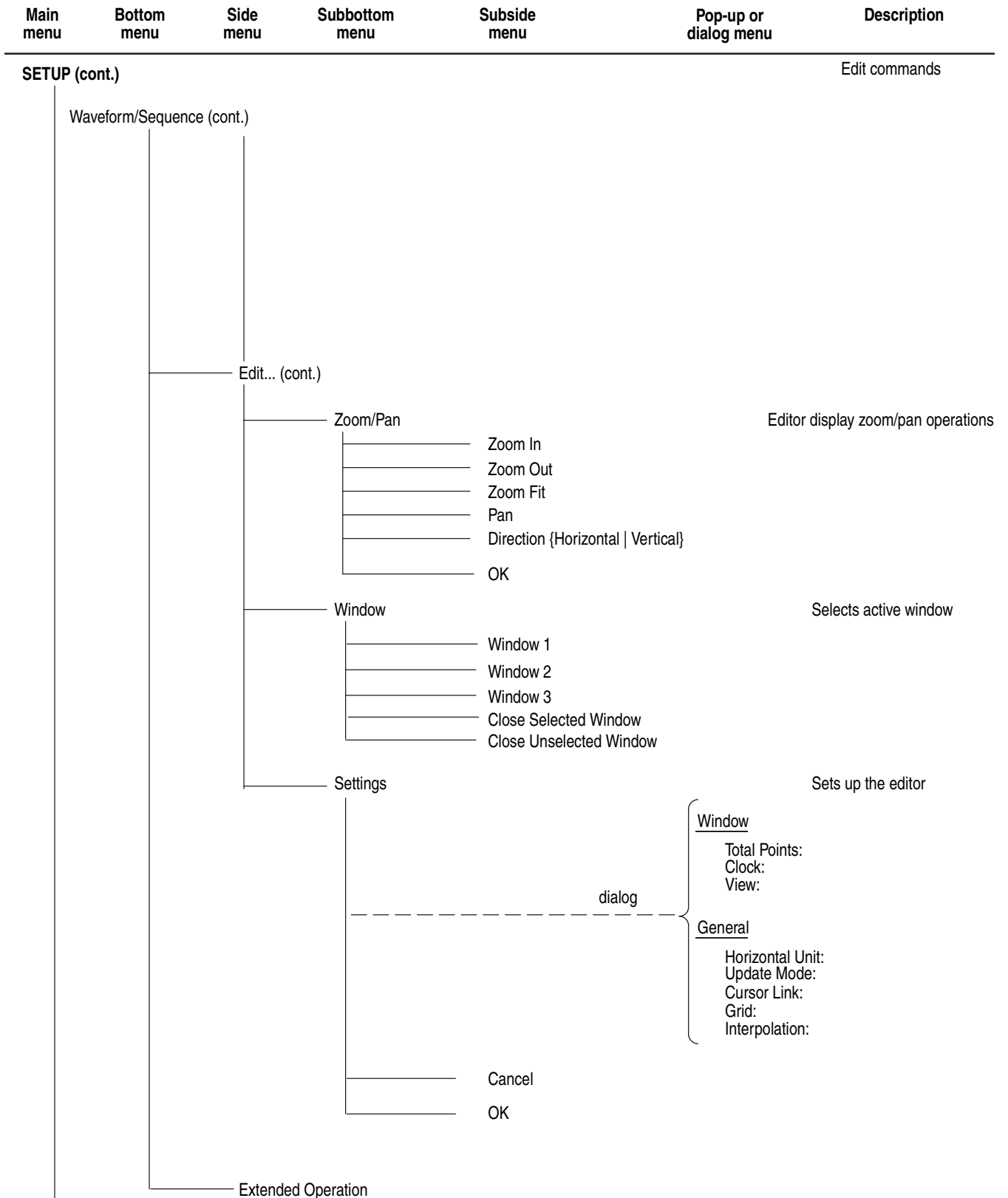

Main menu	Bottom menu	Side menu	Subbottom menu	Subside menu	Pop-up or dialog menu	Description
SETUP (cont.)						
				Note: Use the General Purpose Knob to select.		
	Vertical					Adjusts vertical axis paramete
				Filter {Through 20 MHz 50 MHz 100 MHz 200 MHz Through}, (except option 02)		
				Amplitude (0.02 V _{p-p} to 2.000V _{p-p}), (option 02: 0.5 V _{p-p} to 1.000V _{p-p})		
				Offset (-0.5 V to +0.5V), (except option 02)		
				Marker...		
					Marker 1 High Level (-1.00 to 2.45 V (-1.1 to 3.0V :AWG710))	
					Marker 1 Low Level (-2.00 to 2.40 V (-1.1 to 3.0V :AWG710))	
					Marker 2 High Level (-1.00 to 2.45 V (-1.1 to 3.0V :AWG710))	
					Marker 2 Low Level (-2.00 to 2.40 V (-1.1 to 3.0V :AWG710))	
					Previous menu	
				Output {Normal Direct}, (except option 02)		
	Horizontal					Adjusts horizontal parameters
				Clock (50 kS/s to 4.2 GS/s (50 kS/s to 4.0 GS/s : AWG710))		
				Clock Ref {Internal External}		
				Clock Src {Internal External} (AWG710B only)		
	Run Mode					Selects run mode
				Continuous		
				Triggered		
				Gated		
				Enhanced		
	Trigger					Sets trigger parameters
				Source {External Internal}		
				Slope (or Polarity) {Positive Negative}		
				Level (-5.0 to 5.0 V)		
				Impedance {50 Ω 1 kΩ }		
				Interval (1.0 μs to 10.0s)		
	Save/Restore					Saves/restores current settings
				Save Setup		
				Restore Setup		
	Extend Operation					
				FG...		
				Waveform Mixing		
				Sync - Master		
				Sync - Slave		

the Front Panel Edit button repeatedly to return to the Edit Main menu.

Main menu	Bottom menu	Side menu	Subbottom menu	Subside menu	Pop-up or dialog menu	Description
Ez FG						
Ez FG	Sine					<ul style="list-style-type: none"> Frequency (1.000Hz to 400.0MHz) Amplitude (20mV_{pp} to 2.0 V_{pp} step 1mV), (option 02: 500mV_{pp} to 1.0 V_{pp} step 1mV) Offset (-0.5 to 0.5 V step 1mV), (except option 02) Polarity { Normal Inverted }
	Triangle					<ul style="list-style-type: none"> Frequency (1.000Hz to 400.0MHz) Amplitude (20mV_{pp} to 2.0 V_{pp} step 1mV), (option 02: 500mV_{pp} to 1.0 V_{pp} step 1mV) Offset (-0.5 to 0.5 V step 1mV), (except option 02) Polarity { Normal Inverted }
	Square					<ul style="list-style-type: none"> Frequency (1.000Hz to 400.0MHz) Amplitude (20mV_{pp} to 2.0 V_{pp} step 1mV) ,(option 02: 500mV_{pp} to 1.0 V_{pp} step 1mV) Offset (-0.5 to 0.5 V step 1mV), (except option 02) Polarity { Normal Inverted }
	Ramp					<ul style="list-style-type: none"> Frequency (1.000Hz to 400.0MHz) Amplitude (20mV_{pp} to 2.0 V_{pp} step 1mV), (option 02: 500mV_{pp} to 1.0 V_{pp} step 1mV) Offset (-0.5 to 0.5 V step 1mV), (except option 02) Polarity { Normal Inverted }
	Pulse					<ul style="list-style-type: none"> Frequency (1.000Hz to 400.0MHz) Amplitude (20mV_{pp} to 2.0 V_{pp} step 1mV) ,(option 02:500mV_{pp} to 1.0 V_{pp} step 1mV) Offset (-0.5 to 0.5 V step 1mV), (except option 02) Polarity { Normal Inverted } Duty (0.1% to 99.9%)...
	DC					Offset (-0.5 to 0.5 V step 1mV), (except option 02)
	Exit FG...					; To AWG Mode

Menu Structures

Main menu	Bottom menu	Side menu	Subbottom menu	Subside menu	Pop-up or dialog menu	Description
Waveform Mixing						
	Waveform/Sequence					
		File...				
			Load A File...		Select File	
			Load B File...		Select File	
			Save Mixed Wfm...		Input Filename	
			Previous Menu			
		View...				
			View A			
			View B			
			Previous Menu			
		Settings...				
			Ratio of A (0 to 100 %)			
			Ratio of B (0 to 100 %)			
			Marker {Same as A Same as B}			
			Wfm Len {Same as A Same as B LCM(A,B)}			
			Previous Menu			
		Update (Auto Manual)				
		Update Waveform				
	Vertical					; Same as AWG Mode
		Filter				
		Amplitude				
		Offset				
		Marker				
		Output				
	Horizontal					; Same as AWG Mode
		Clock				
		Clock Ref				
		Clock Src				
	Run Mode					; Same as AWG Mode
		Continuous				
		Triggered				
		Gated				
		Enhanced				
	Trigger					; Same as AWG Mode
		Source				
		Slope				
		Level				
		Inpedance				
		Interval				
	Exit Mix...					; To AWG Mode

Main menu	Bottom menu	Side menu	Subbottom menu	Subside menu	Pop-up or dialog menu	Description
Sync - Master						
	Waveform/Sequence					
		Load...			Select File	
			Up Level			
			Down Level			
			Drive		Select Drive	
			Cancel			
			OK			
		View...				
			OK			
	Vertical					; Same as AWG Mode
		Filter				
		Amplitude				
		Offset				
		Marker				
		Output				
	Horizontal					; Same as AWG Mode
		Clock				
		Clock Ref				
		Clock Src				
	Run Mode					; Same as AWG Mode
		Continuous				
		Triggered				
		Gated				
		Enhanced				
	Trigger					; Same as AWG Mode
		Source				
		Slope				
		Level				
		Inpedance				
		Interval				
	Connect					
		Connect to Slave				
		Execute Trig Timing Calibration				
		Disconnect				
		Execute Ping...				
		Edit Slave IP Address...				
	Exit Sync...					; To AWG Mode

Menu Structures

Main menu	Bottom menu	Side menu	Subbottom menu	Subside menu	Pop-up or dialog menu	Description
Sync - Slave						
	Waveform/Sequence					
		Load...			Select File	
			Up Level			
			Down Level			
			Drive		Select Drive	
			Cancel			
			OK			
		View...				
			OK			
	Vertical					; Same as AWG Mode
		Filter				
		Amplitude				
		Offset				
		Marker				
		Output				
	Exit Sync...					; To AWG Mode

EDIT Menu Hierarchy

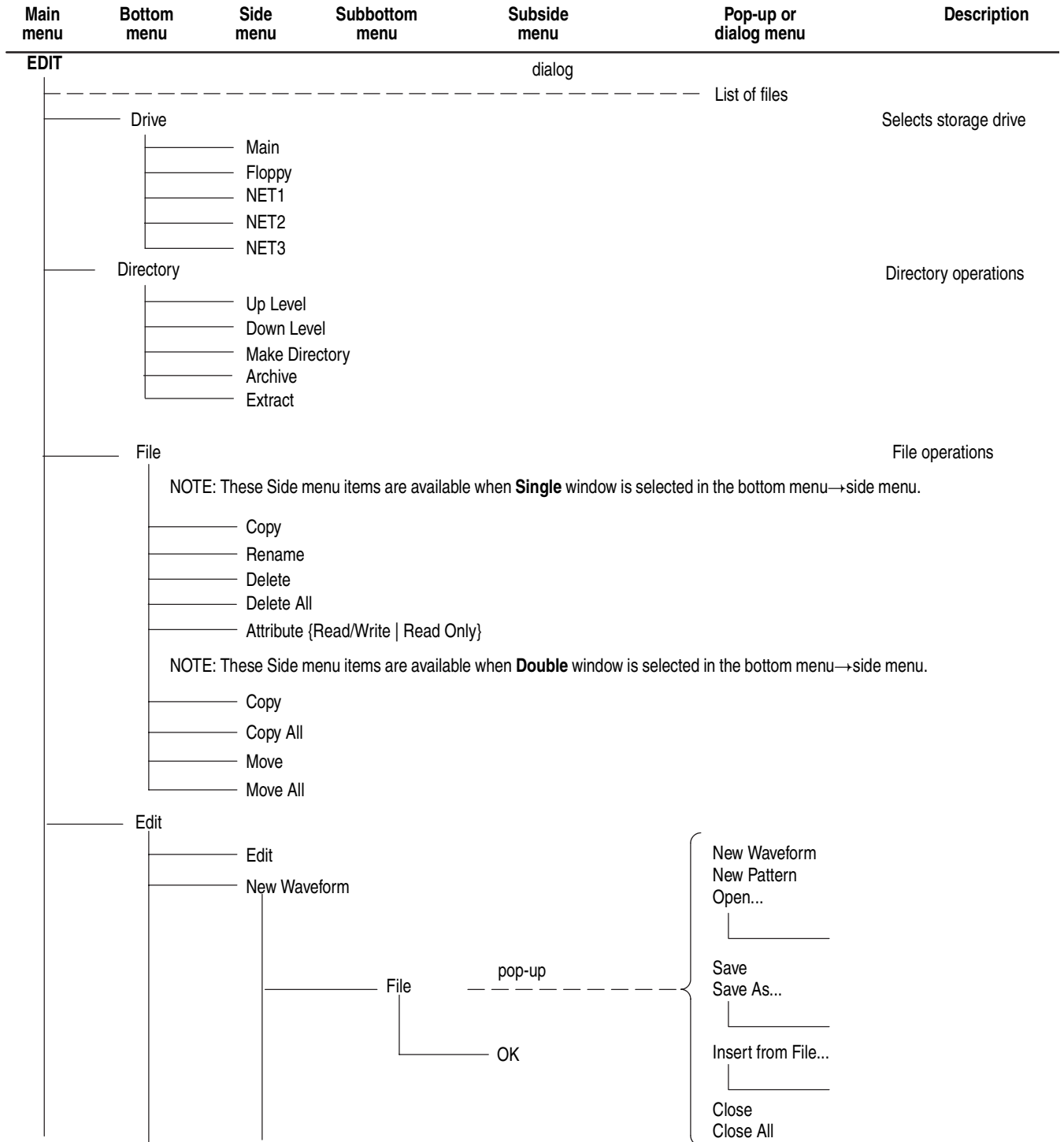

Menu Structures

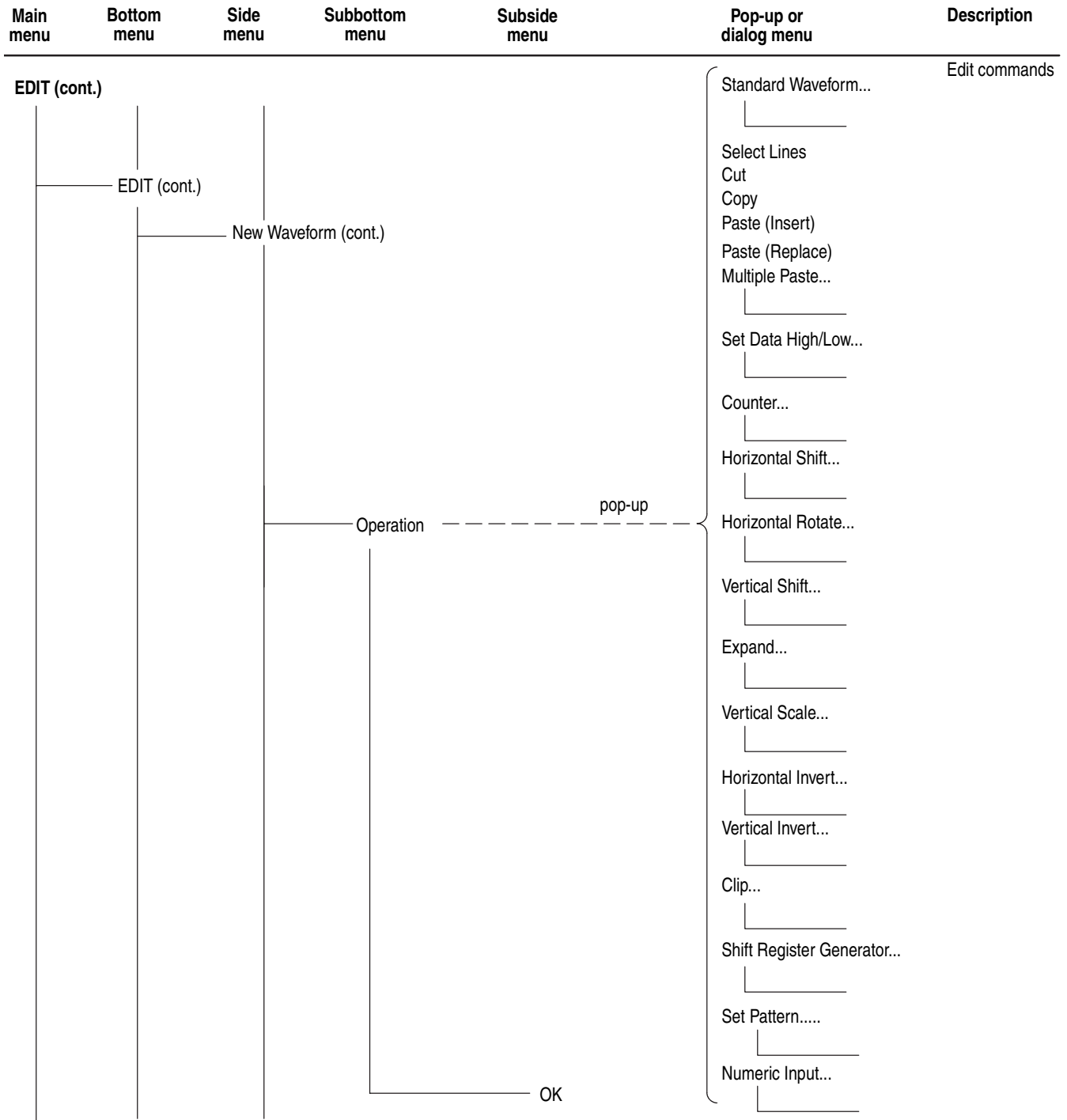

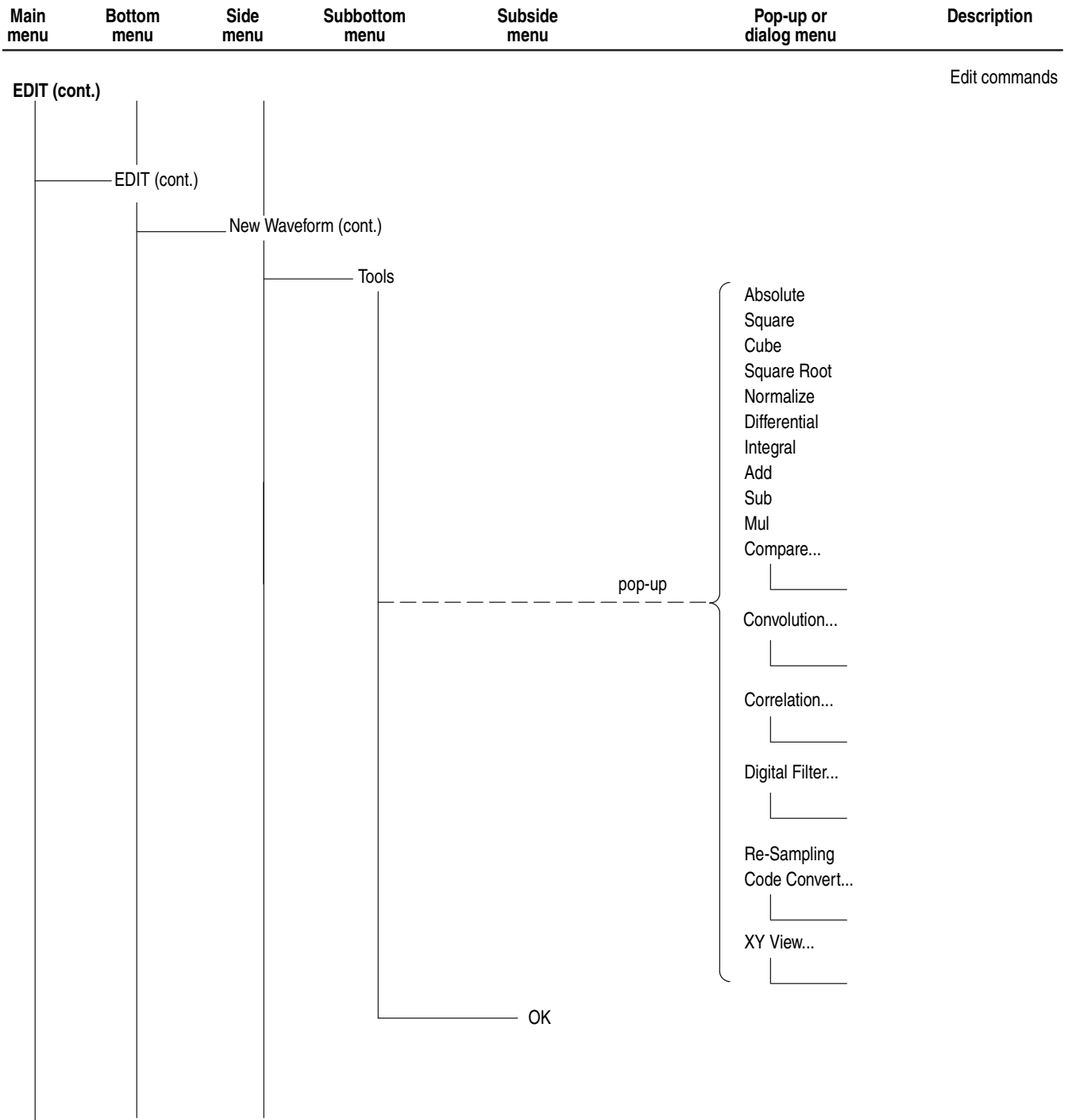

Menu Structures

Main menu	Bottom menu	Side menu	Subbottom menu	Subside menu	Pop-up or dialog menu	Description
	EDIT (cont.)					
		New Waveform (cont.)				
			Zoom/Pan			Editor display zoom/pan operations
				Zoom In		
				Zoom Out		
				Zoom Fit		
				Pan		
				Direction {Horizontal Vertical}		
			Window			Selects active window
				Window 1		
				Window 2		
				Window 3		
				Close Selected Window		
				Close Unselected Window		
			Settings			Sets up the editor
					Window	
					Total Points:	
					Clock:	
					View:	
					General	
					Horizontal Unit:	
					Update Mode:	
					Cursor Link:	
					Grid:	
					Interpolation:	
				Cancel		
				OK		
			Undo!			Reverses edit to prior operation

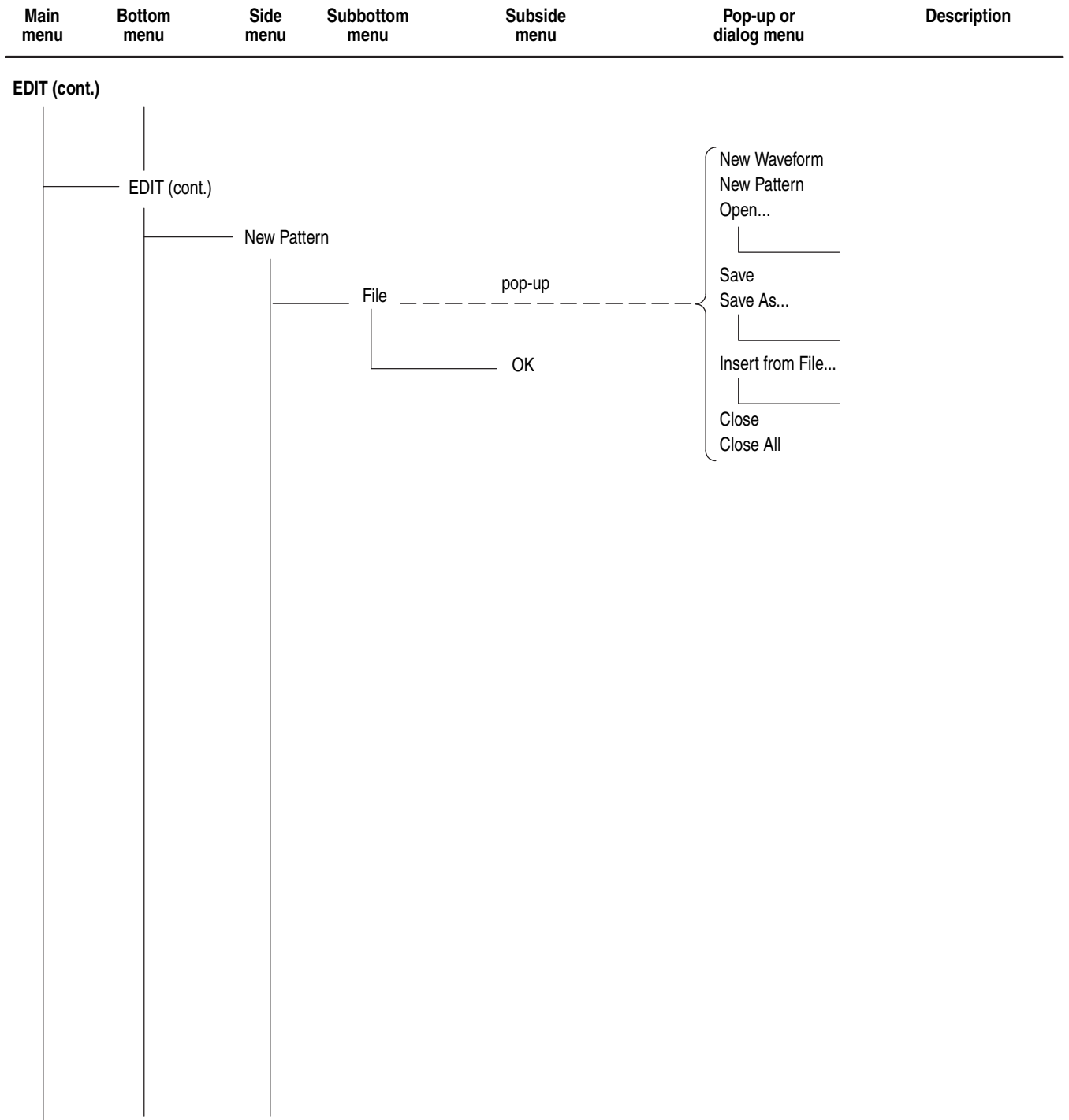

Menu Structures

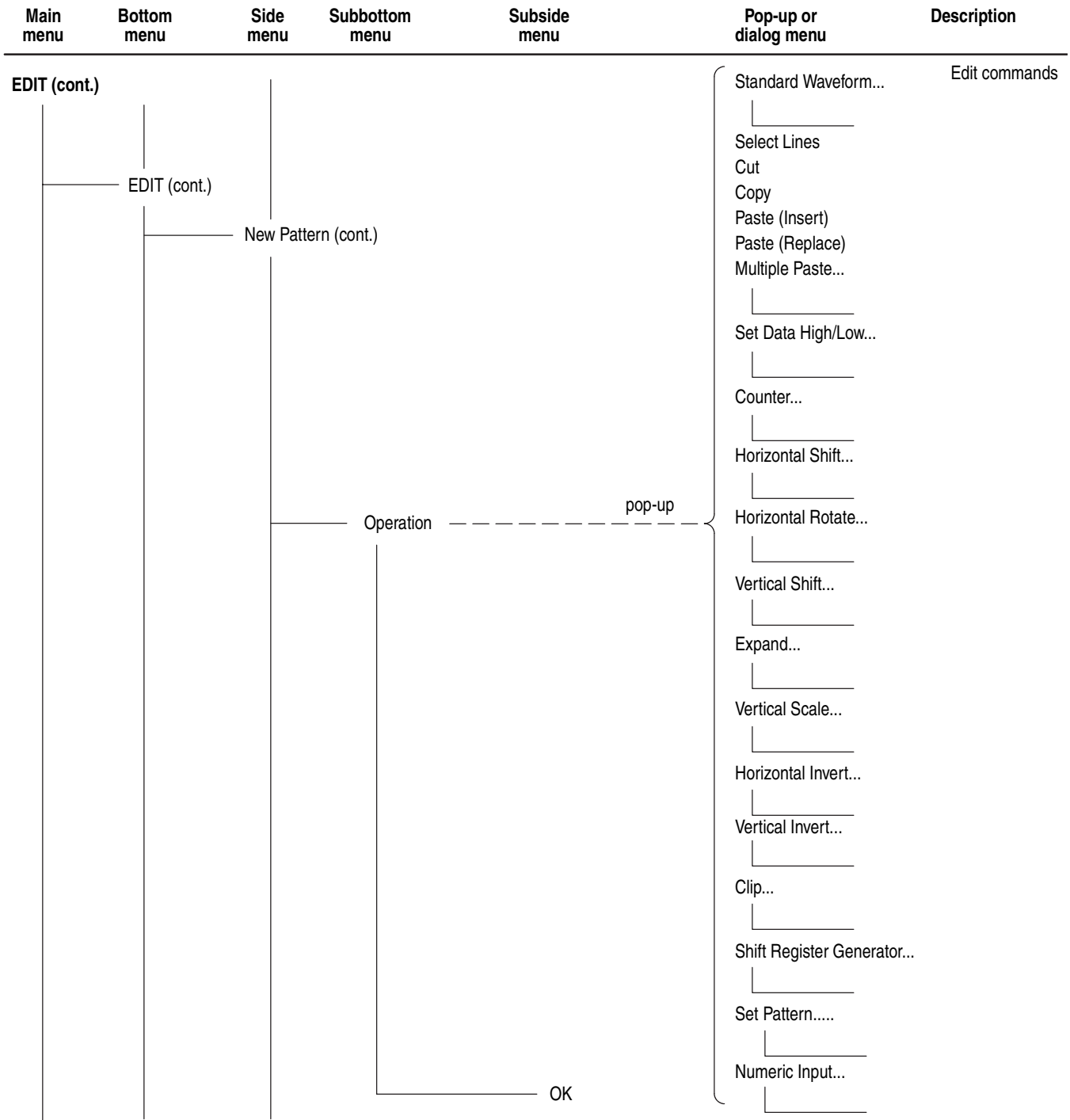

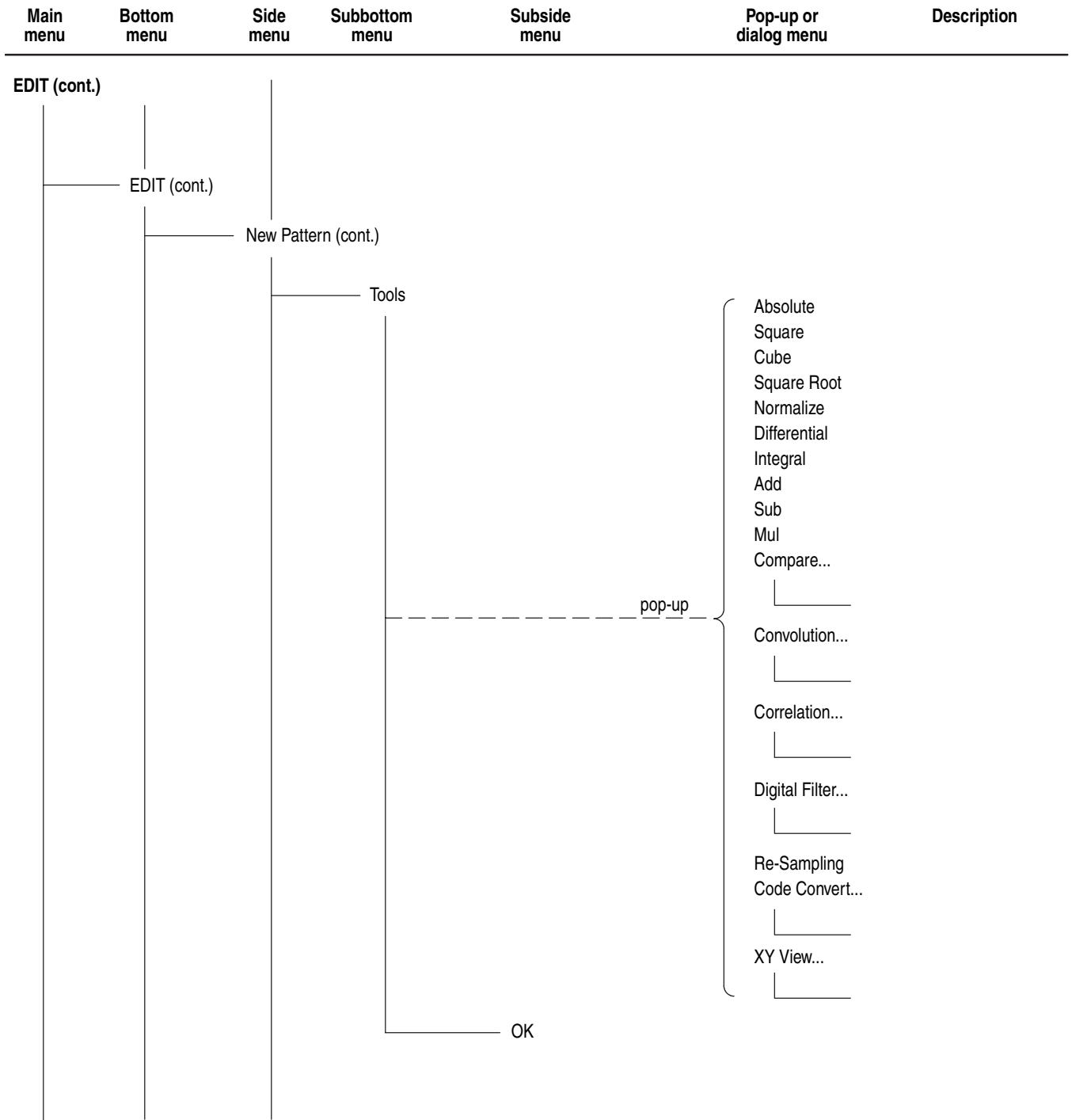

Menu Structures

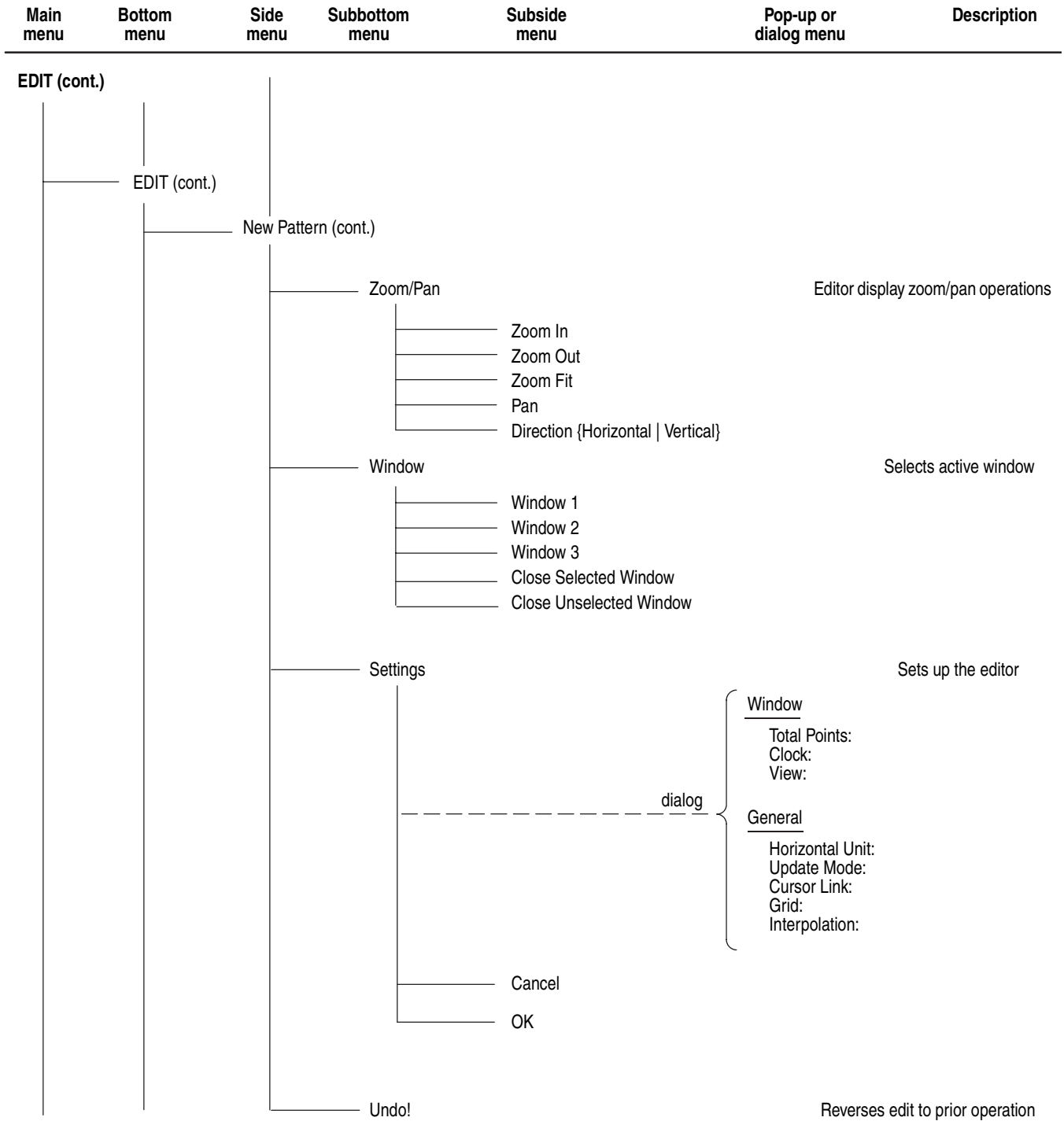

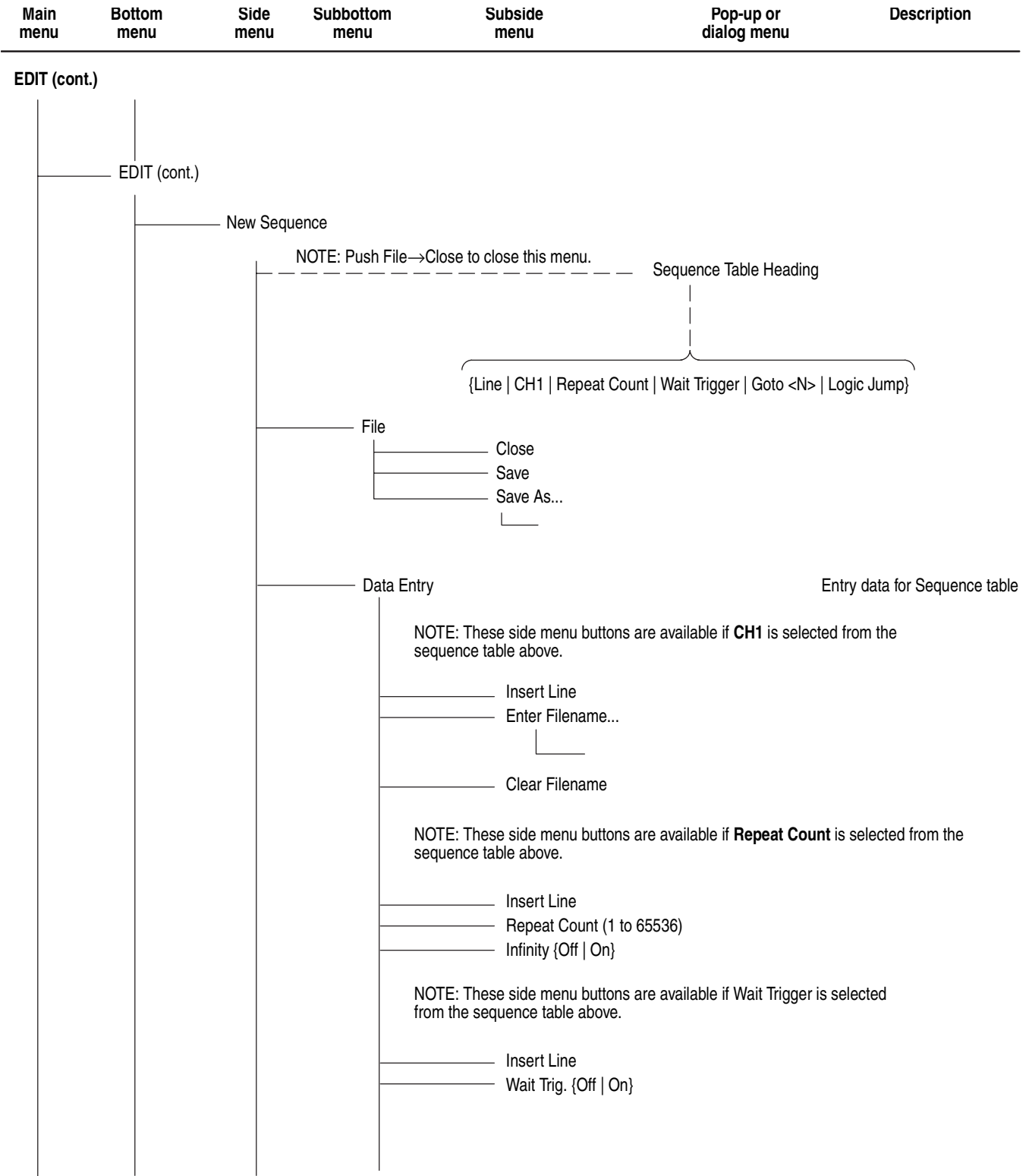

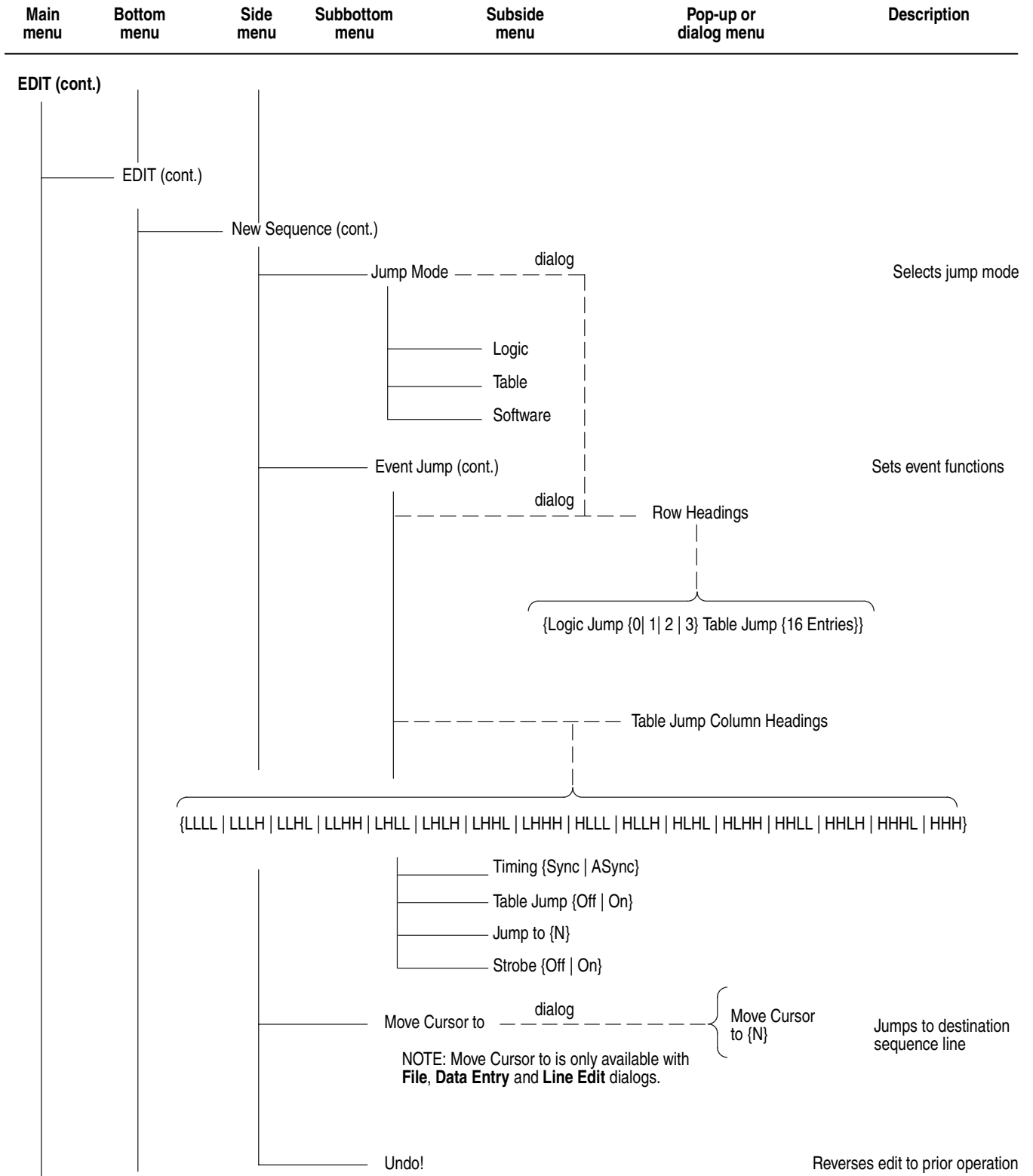

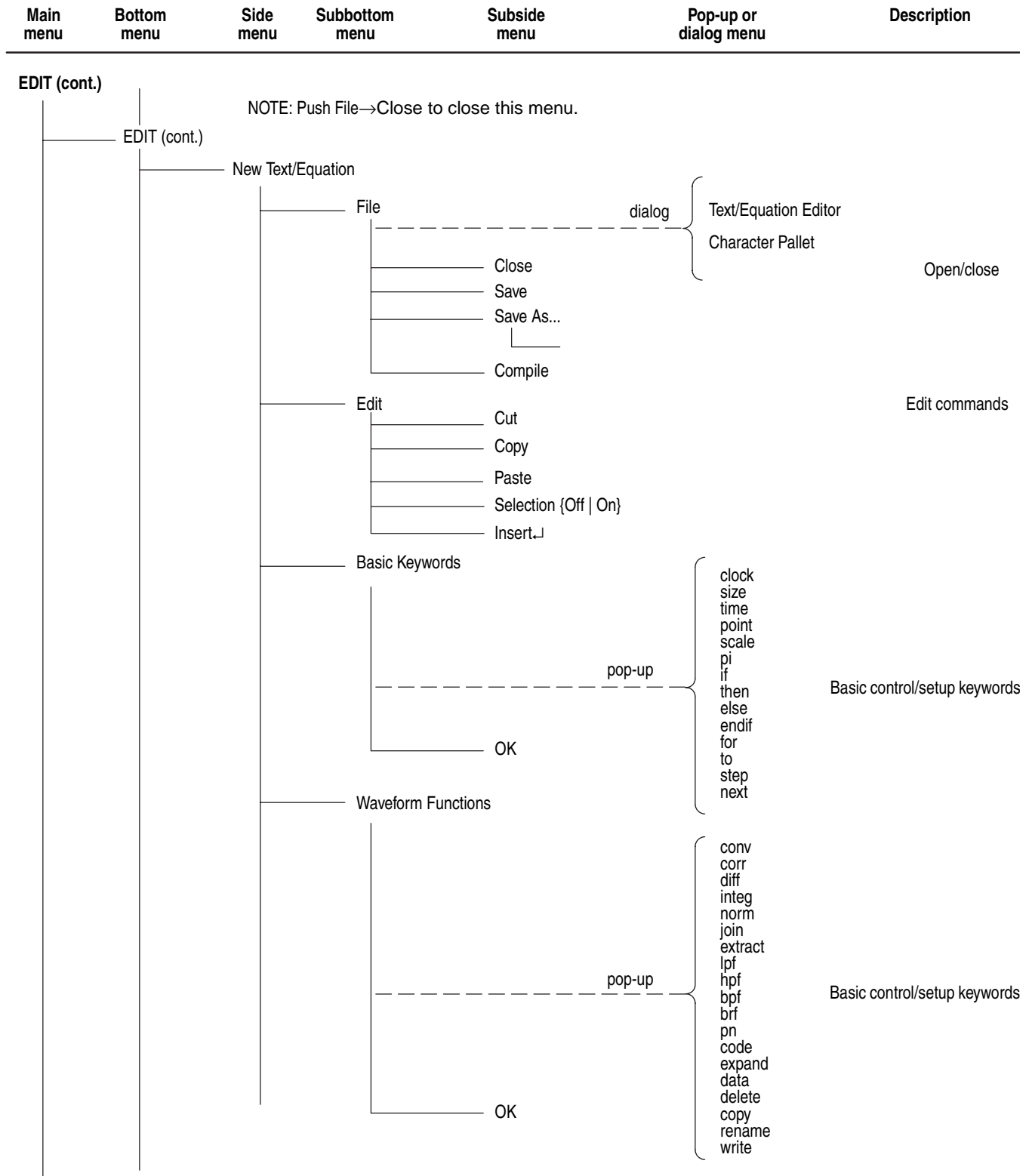

Main menu	Bottom menu	Side menu	Subbottom menu	Subside menu	Pop-up or dialog menu	Description
EDIT (cont.)	EDIT (cont.)	New Text/Equation (cont.)	Math Functions		exp log log10 sqrt sin cos tan abs sign max min pow rnd srnd sinc tri saw sqr noise	Mathematical operation keywords
			More Math Functions		and or floor ceil int round asin acos atan sinh cosh tanh	Mathematical operation keywords
			Undo!	OK		
	Tools		Compile Equation			Converts to waveform files
			Convert File Format...			
			Compile AWG20XX Equation			
			Capture Waveform...	Dialog menu	Source Loaded As	Imports waveform from instruments
	Update!					
	Window		Window {Single Double}			Writes to the waveform memory
			Select {Upper Lower}			Double Windows operations

APPL Menu Hierarchy

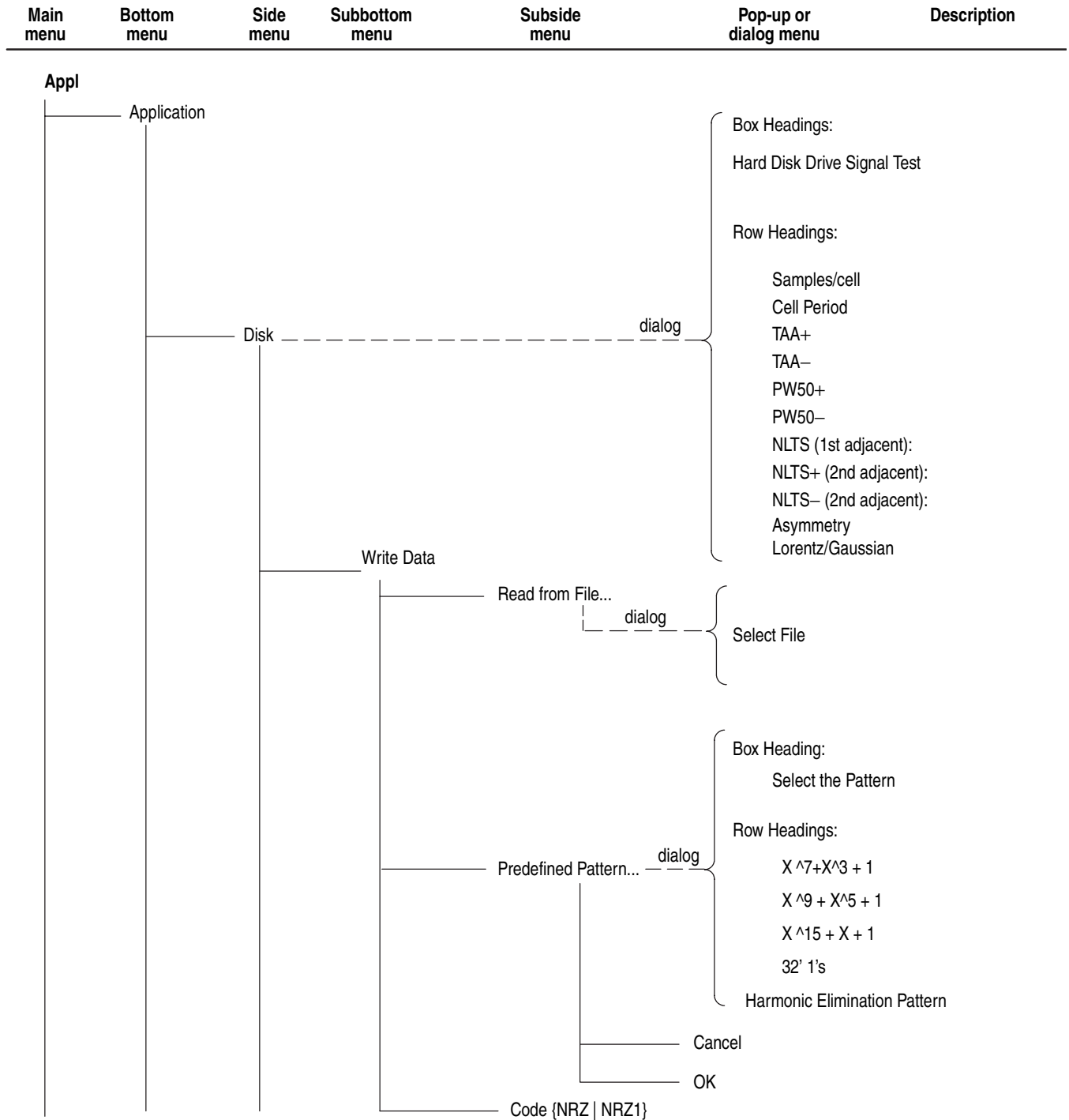

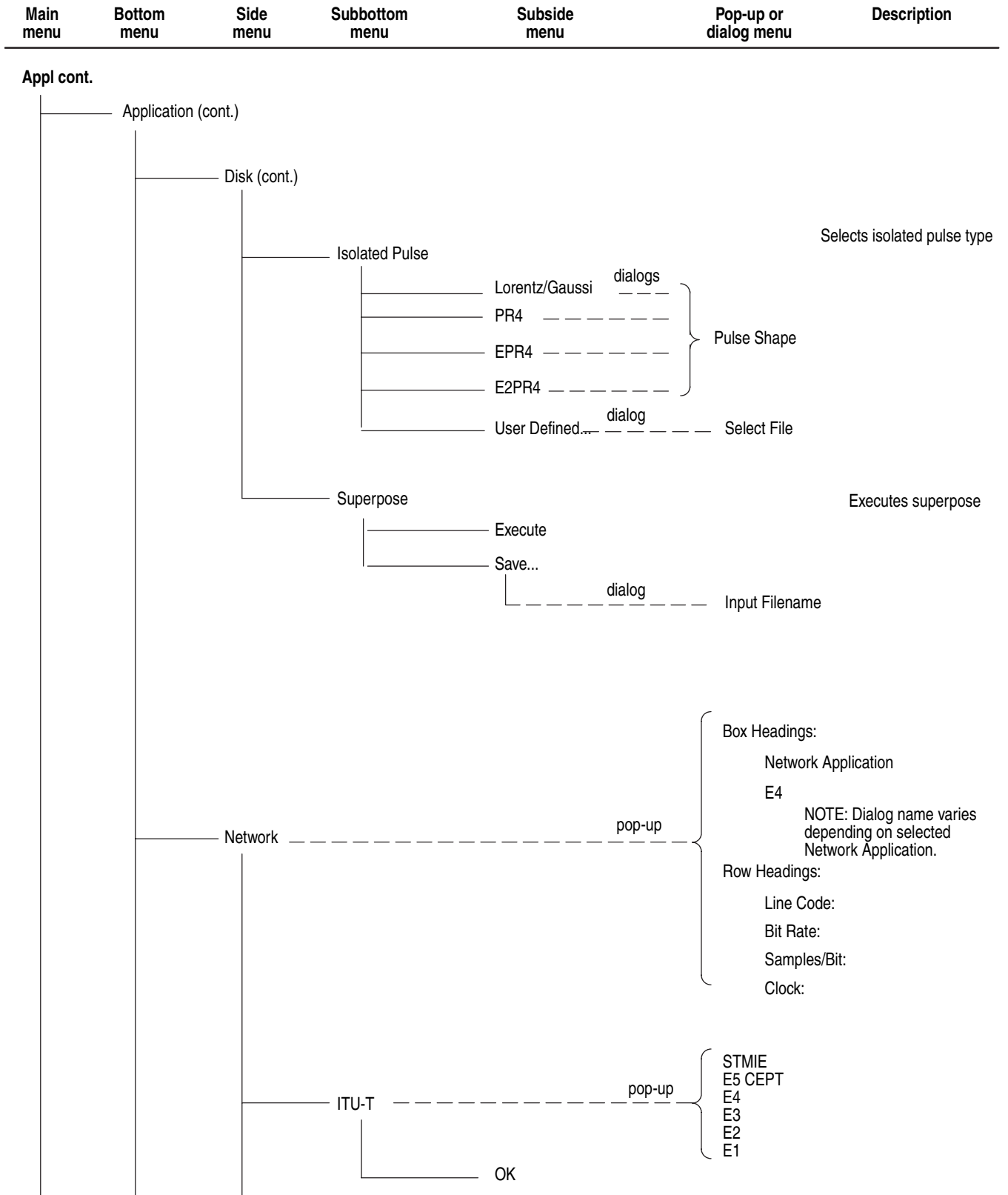

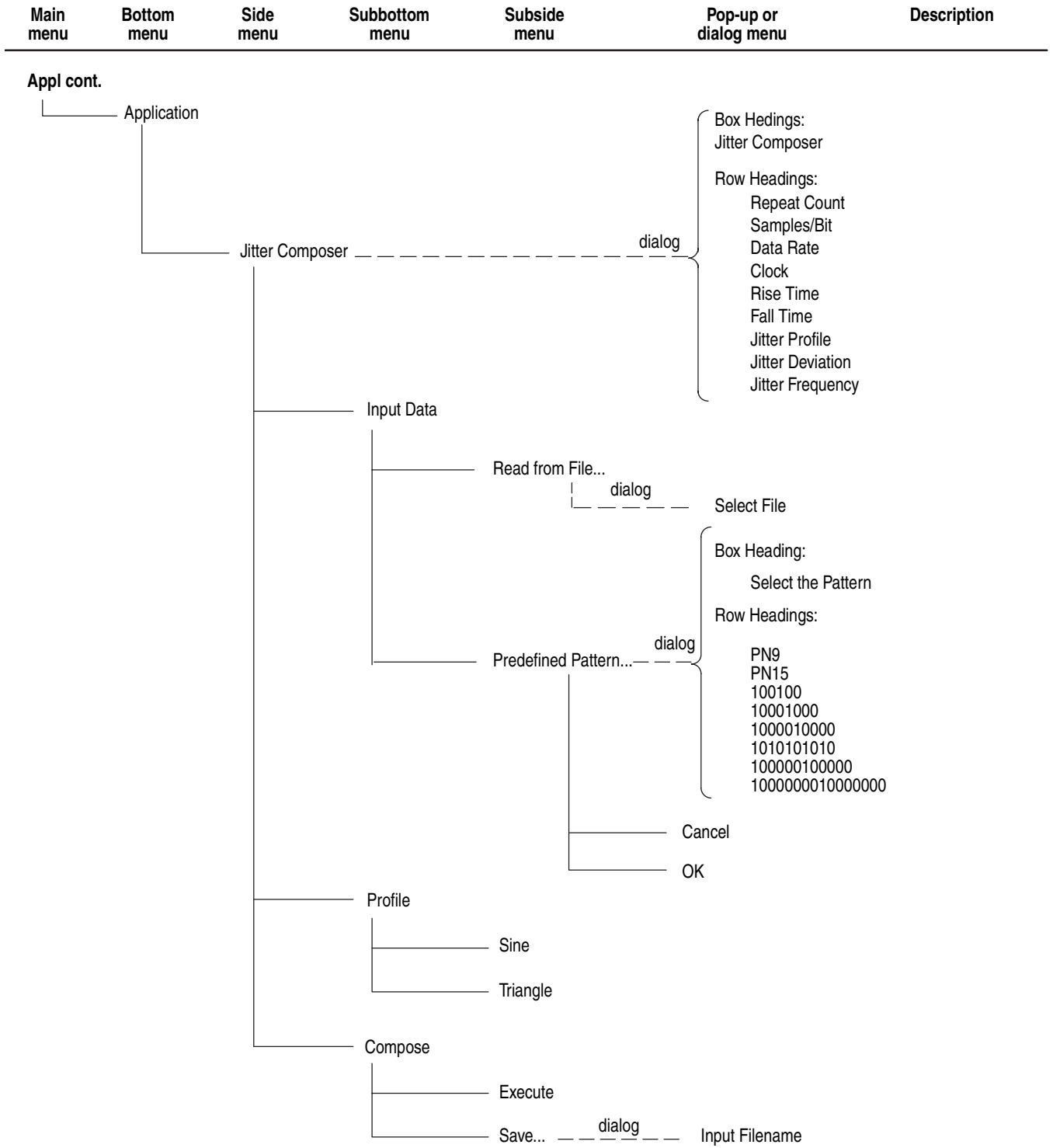

Utility Menu Hierarchy

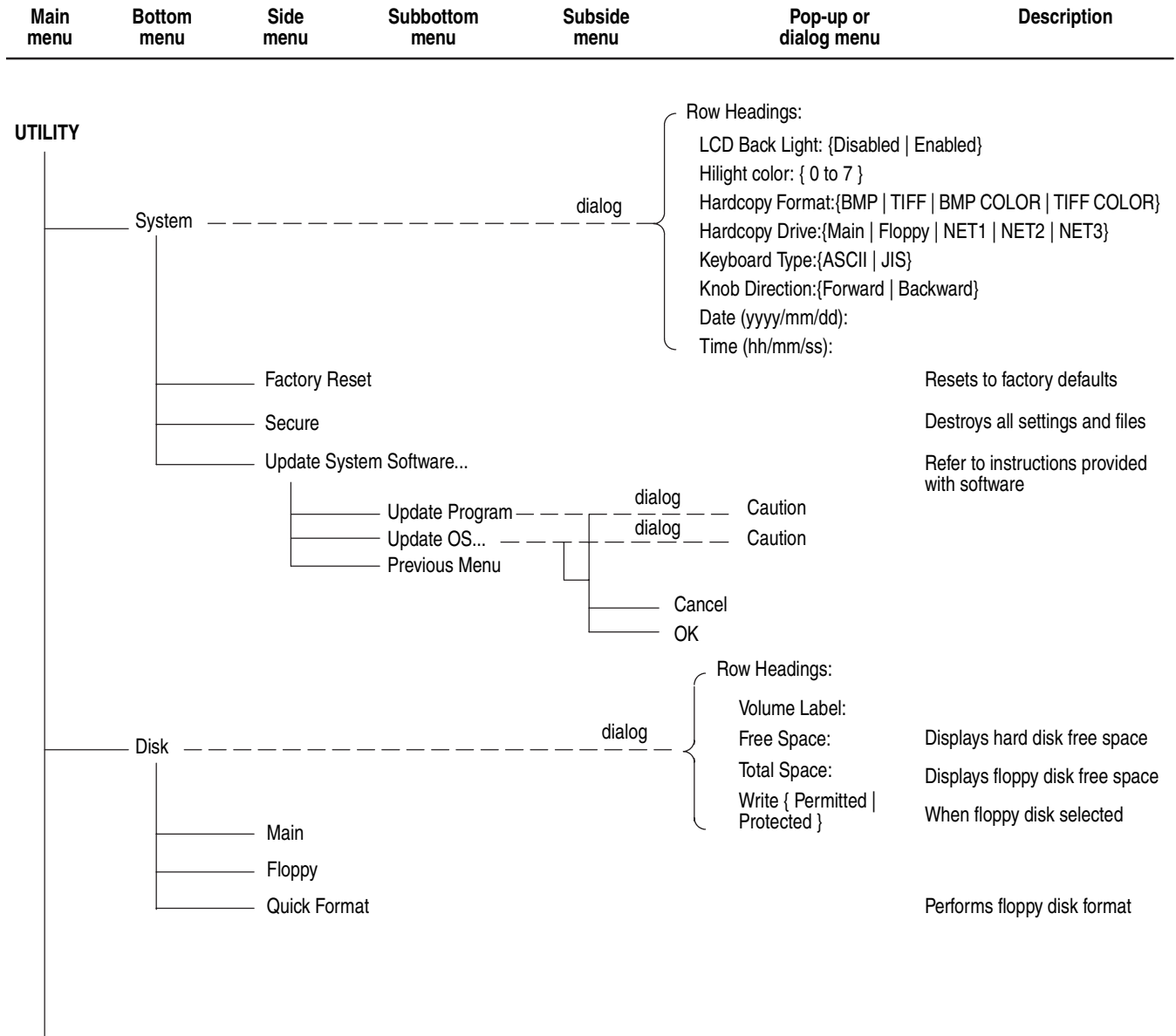

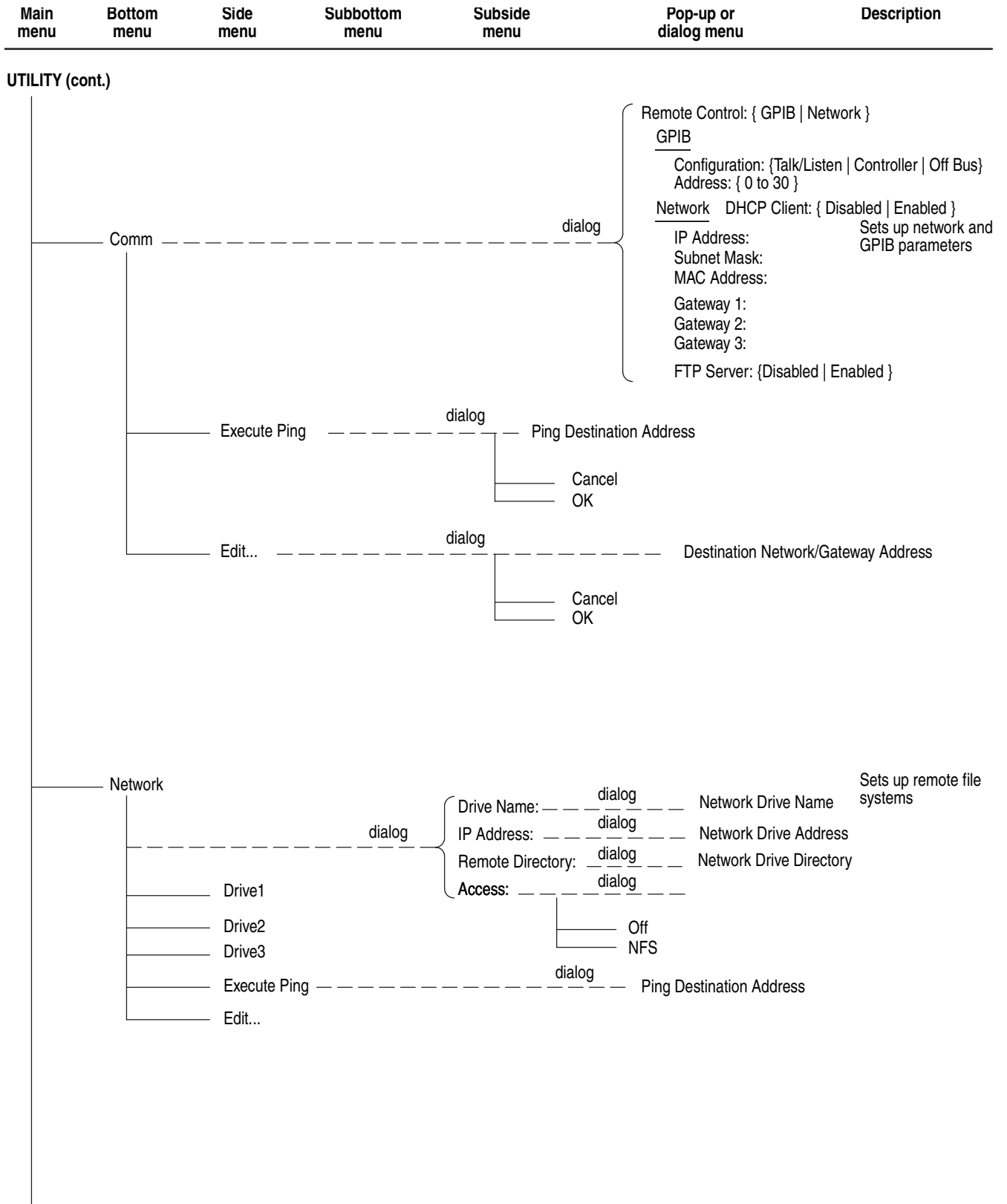

Menu Structures

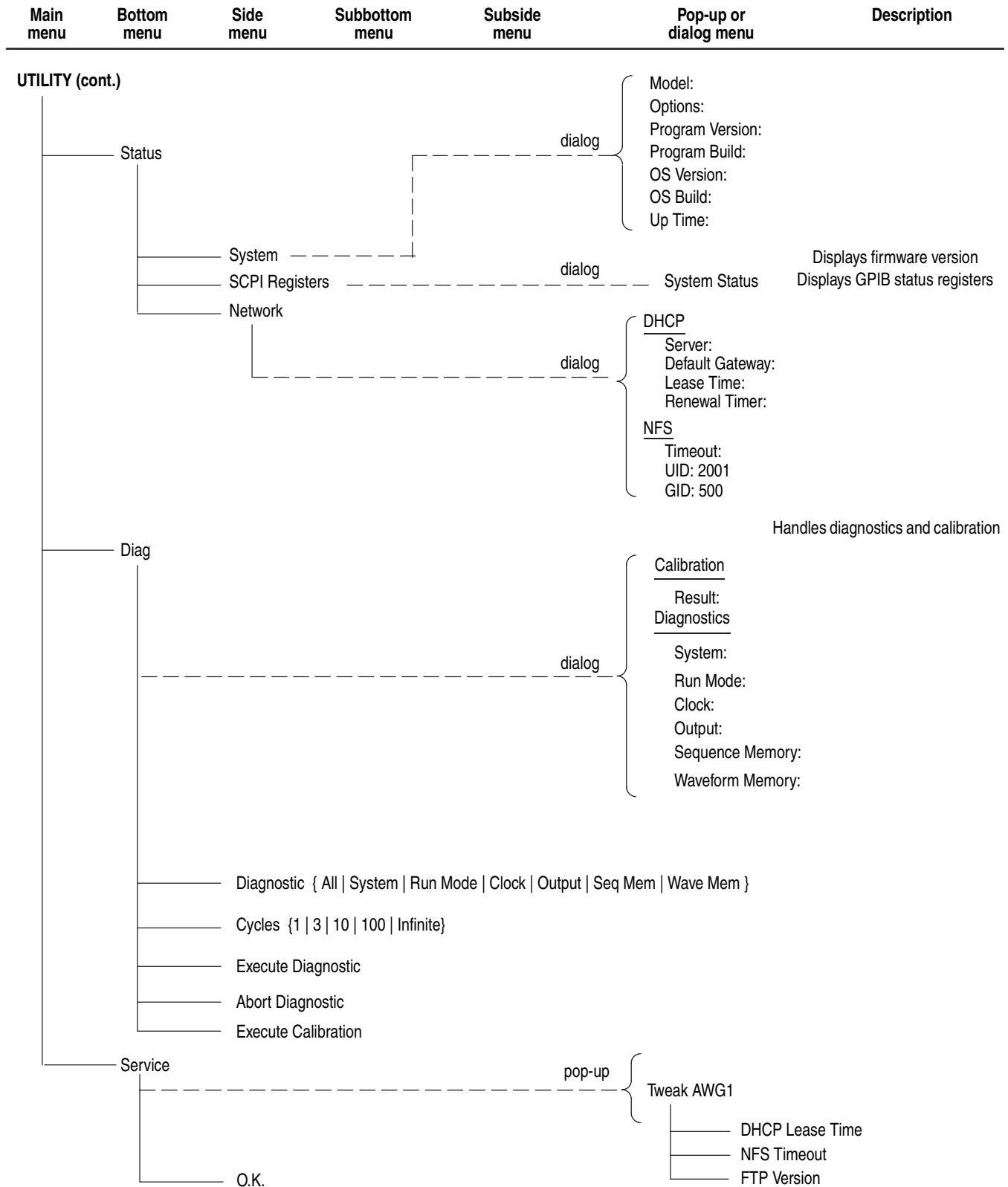

The Setup Menu Screen

This section describes the key elements of the Setup menu screen, how to load a file, how to set the signal output parameters, and how to enable signal output.

Setup Menu Screen Elements

To open the Setup menu screen, push the **SETUP** front-panel button. Refer to Figure 3-2. Table 3-2, 3-3 and 3-4 describe the Setup menu screen elements. Table 3-3 describes the bottom menu functions. Following Table 3-4 the menu operations are discussed in detail, grouped by bottom menu function.

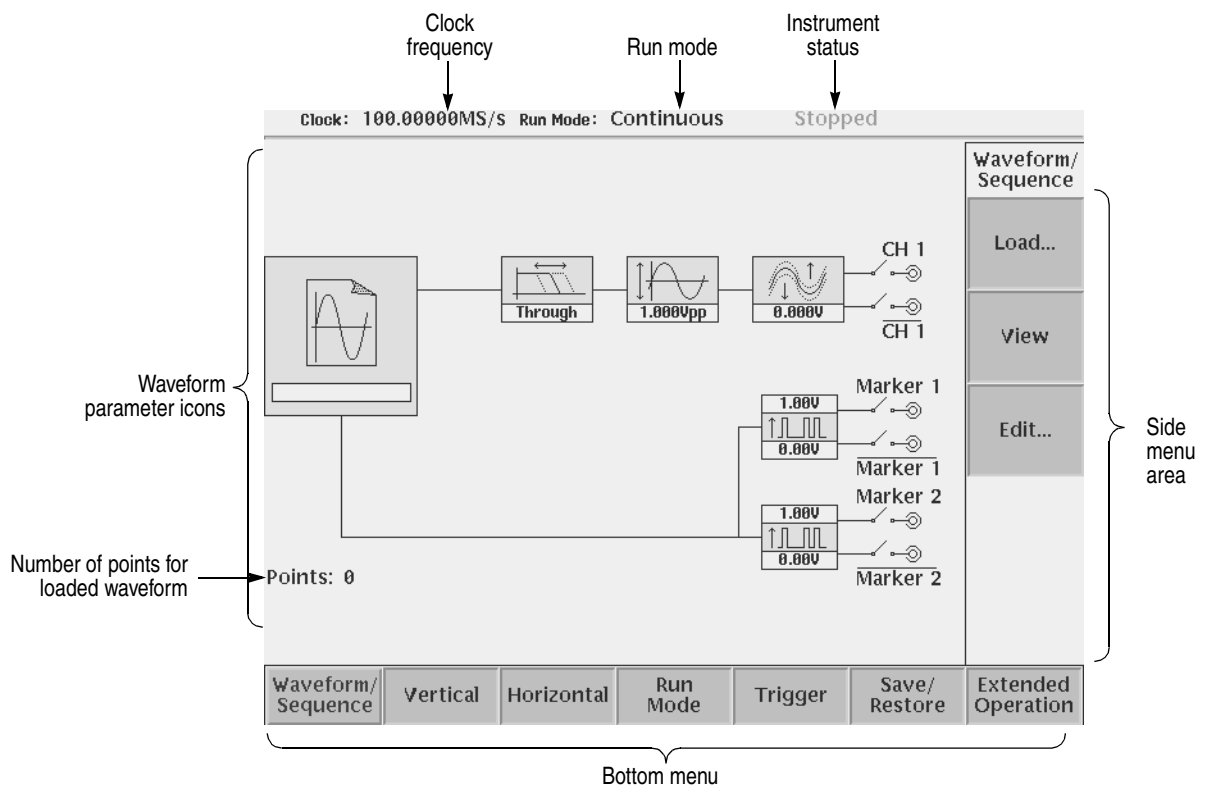

Figure 3-2: Setup main screen (except option 02)

Table 3-2: Waveform parameter icons





Element	Description	Element	Description
	Displays the file name of the waveform, pattern, or sequence file loaded for output. Note: use the View button to display the loaded waveform.		Displays the digital output and marker signal minimum and maximum voltage settings.
	Displays the lowpass filter setting through which the waveform is passed. (except option 02)		Indicates that the channel output is enabled or disabled. If the switch is shown open, that channel output is disabled.
	Displays the peak-to-peak signal amplitude setting.		Indicates that the marker output is enabled or disabled. All Marker outputs are controlled by the ALL MARKER OUT ON/OFF button.
	Displays the signal offset setting. (except option 02)		

Table 3-3: Setup bottom menu buttons

Bottom menu button	Description
Waveform/Sequence	Displays the side menu for loading, viewing, editing waveform files, and entering the FG mode main screen.
Vertical	Displays the Vertical side menu for setting waveform peak-to-peak amplitude, offset, lowpass filter, marker, and other output parameters. The product which has option 02 doesn't have offset and lowpass filter function.
Horizontal	Displays the Horizontal side menu for setting the clock source, clock frequency, and marker signal delay parameters.
Run Mode	Displays the Run Mode side menu for setting the instrument run mode. Refer to the <i>Run Modes</i> section on page 3-44 for an explanation of the different run modes.
Trigger	Displays the Trigger side menu for setting trigger source, slope, level, external trigger impedance, and interval parameters.
Save/Restore	Displays the Save/Restore side menu to save and restore setup output parameters.

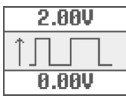
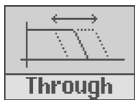
Table 3-3: Setup bottom menu buttons

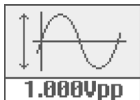
Bottom menu button	Description
Extended Operation	Displays the Extended Operation side menu to select four operation modes AWG mode, FG mode, Waveform Mixing mode, and Synchronous Operation mode.

Table 3-4: Status area

Item	Description
Clock	<p>Displays the clock rate of an internal clock or an external clock. The clock rate of an external clock is measured and displayed when external clock use. The following message is displayed in addition to a numerical value.</p> <ul style="list-style-type: none"> ■ PLL UNLOCKED: There is no Ref In signal when Clock Src is Internal and Clock Ref is External. ■ NO SIGNAL: There is no Clock signal when Clock Src is External. ■ OUT OF RANGE: The clock rate of a external clock signal is out of range when Clock Src is External. ■ NOT STABLE: The clock rate of a external clock signal is within range but not stable when Clock Src is External.
Run Mode	Displays the Run Mode selected on the Run Mode menu.
Instrument status	<p>The following state of a sequencer of operation is displayed.</p> <ul style="list-style-type: none"> ■ Stopped: Output operation has stopped. ■ Running: Output operation is executing. ■ Waiting: Waiting for a trigger signal or an event signal where the run mode is except Continuous.

The Waveform/Sequence Menu

The Waveform/Sequence menu is used for loading, viewing, and editing waveform files.

Load... The **Load...** button lets you load a waveform, pattern, or sequence file to output. Do the following steps to load a file:

1. Push **SETUP** (front)→**Waveform/Sequence** (bottom)→**Load...** (side).
2. Select a waveform file, pattern file or sequence from the file listing in the Select File dialog box that appears on the screen.
3. Push the **OK** side button.

Waveform and Pattern File Restrictions. The following list describes some restrictions regarding the loading of waveform and pattern files.

- The waveform and pattern files can be loaded from different drives and/or directories.
- If you try to load a file that is larger than the available waveform memory, or that is not a waveform, sequence or pattern format file, the instrument displays the following error message and clears the waveform memory:

Illegal file format

A valid waveform, sequence, or pattern file needs to be loaded.

Sequence Files. The following list describes some restrictions on loading sequence files.

- When sequence file loading fails, the instrument clears loaded output file names and waveform memory.
- Sequence file loading fails if any one of the following conditions are true:
 - There is a null character (“ ”) in the CH1 file name field of the sequence table.
 - The instrument cannot locate the waveform, pattern, or subsequence file specified in the sequence table. All waveform, pattern, and subsequence files must be at the same location and the instrument drive and path settings must point to that location.
 - There are too many lines in the sequence table. The maximum number of lines is 8000.
 - There is more than one nesting level of subsequence files. The maximum nesting level is one.
 - The sequence calls itself.

- The destination of a line jump specified in the sequence table is greater than the number of lines in the sequence table.

Equation Files. You cannot load an equation file to output a signal. You must first compile the equation file into a *.wfm* file prior to loading the waveform file.

View This button lets you view a loaded waveform by pushing the **View** side menu button. The instrument opens a window on the screen and displays the loaded waveform. Push the **OK** side button to close the view window.

Edit... This button opens the appropriate editor for a loaded waveform, pattern, or sequence file. Do the following steps to edit a loaded waveform or sequence file:

1. Push **SETUP** (front)→**Waveform/Sequence** (bottom)→**Edit...** (side).
The instrument opens the appropriate editor for the loaded waveform.

NOTE. *The waveform and pattern editors have an output auto-update function that can update the output waveform while you are editing the file. It has two modes: Auto and Manual. Auto updates the waveform memory whenever there are changes to the edit buffer. Manual updates waveform memory when you save the file. To set the auto-update mode, push the **Settings** bottom menu button from an editor screen.*

The Vertical Menu

The Vertical menu lets you set waveform (analog and markers) vertical parameters. You can set signal peak-to-peak range, offset voltage, and lowpass filter frequency. The Vertical menu commands are Filter, Amplitude, Offset, Marker... and Output.

NOTE. You can change the analog output amplitude and offset values directly in any screen by using the Vertical *LEVEL/SCALE* and *OFFSET* knobs on the front-panel, respectively.

The product which has option 02 doesn't have offset and lowpass filter function.

You can display the Setup Vertical menu at any time by pushing the *VERTICAL MENU* front-panel button.

Filter (except option 02)

This button lets you set the lowpass filter. You can select 20 MHz, 50 MHz, 100 MHz, 200 MHz or Through (no limiting).

Do the following steps to set the output waveform band limit:

1. Push **SETUP** (front)→**Vertical** (bottom)→**Filter** (side). The instrument highlights the Through screen icon.
2. Use the general purpose knob to select 20 MHz, 50 MHz, 100 MHz, 200 MHz or Through.

Amplitude

This button lets you set the analog waveform signal output voltage range from 20 mV_{p-p} to 2.0 V_{p-p} (option 02: 500mV_{p-p} to 1.0V_{p-p}), in 1 mV increments, terminated into 50 Ω. You can only get the maximum output of 2.0 V_{p-p} (option 02: 1.0V_{p-p}) if the waveform file is using the full 8-bit DAC range of ±1.000.

To set the marker output levels, refer to the Marker... menu description on page 3-39.

Do the following steps to set the waveform output levels:

1. Push **SETUP** (front)→**Vertical** (bottom)→**Amplitude** (side). The instrument highlights the Amplitude screen icon.
2. Use the general purpose knob, numeric buttons, keyboard, or **LEVEL/SCALE** knob to set the output amplitude value. If you use a knob, use the ◀ or ▶ button to select the digit to change.

Offset
(except option 02)

This button lets you set the waveform output offset voltage. You may set any value from -0.500 to 0.500 V in 1 mV increments. The VERTICAL:OFFSET knob on the front panel works in every display except Quick Edit.

Do the following steps to set the waveform offset value:

1. Push **SETUP** (front)→**Vertical** (bottom)→**Offset** (side). The instrument highlights the Offset screen icon.
2. Use the general purpose knob, numeric buttons, keyboard, or VERTICAL:OFFSET knob to change the offset value. If you use the general purpose knob, use the ◀ or ▶ buttons or keys to select the digit to change.

Marker...

This button lets you set the marker 1 and 2 high and low levels. You may set any value from $-2.00 \leq \text{Low} \leq 2.40 \text{ V}$, $-1.00 \leq \text{High} \leq 2.45 \text{ V}$, $\text{Low} \leq \text{High}$ ($-1.1 \leq \text{Low} \leq \text{High} \leq 3.0 \text{ V}$:AWG710) in 50 mV increments. The value of Low must always be less than or equal to the value of High. The maximum marker output level (High - Low) is $1.25 \text{ V}_{\text{p-p}}$ ($2.5 \text{ V}_{\text{p-p}}$:AWG710) when the output signal is terminated into 50Ω .

Do the following steps to set the marker signal high and low output levels:

1. Push **SETUP** (front)→**Vertical** (bottom)→**Marker...** (side). The instrument highlights the Marker screen icon for the selected channel.
2. Push the side menu button for the marker signal value you want to change.
3. Use the general purpose knob, numeric buttons, or keyboard to change the marker value. If you use the general purpose knob, use the ◀ or ▶ buttons or keys to select the digit to change.

Output
(except option 02)

This button selects the Normal or Direct output mode. In the Direct mode, the instrument analog output is connected directly to the output connector, bypassing the internal analog filter and offset circuit. The analog waveform signal output voltage range is from $20 \text{ mV}_{\text{p-p}}$ to $1.0 \text{ V}_{\text{p-p}}$, in 1 mV increments, terminated into 50Ω . The maximum signal level is $\pm 0.5 \text{ V}$.

The filter setting and offset setting are not provided in the direct mode.

To connect the instrument analog output directly to the CH1 and $\overline{\text{CH1}}$ output connectors, push **SETUP** (front)→**Vertical** (bottom)→**Output** (side) to select Direct.

To connect the instrument analog output back to the signal vertical parameter functions, push **SETUP** (front)→**Vertical** (bottom)→**Output** (side) to select Normal.

The Horizontal Menu

The Horizontal menu lets you set waveform (analog and markers) horizontal parameters for all output channels. The horizontal parameters include sample clock source (internal or external) and clock frequency. The Horizontal menu commands are Clock and Clock Ref.

The instrument uses only one clock sample frequency rate for all output signals, regardless of individual waveform settings.

NOTE. Use the **SAMPLE RATE/SCALE** knob to adjust the clock frequency directly, without having to open the Horizontal menu.

You can open the Horizontal menu by pushing the **HORIZONTAL MENU** front-panel button. This is the same as pushing **SETUP** (front)→**Horizontal** (bottom).

The **HORIZONTAL OFFSET** knob on the front-panel is available only for the Quick Editor. Refer to **HORIZONTAL OFFSET** knob on page 3-102.

Clock This button lets you set the data sample clock rate used to output a waveform. Sample rates range from 50.000000 kS/s to 4.2000000 GS/s (50.000000 kS/s to 4.0000000 GS/s :AWG710). (The sample rate controls the frequency of the output waveform frequency, which is calculated as follows:

$$F_{out} = \frac{\text{Sample Clock Freq}}{\text{Samples per Cycle}}$$

For example, if the clock rate is 100 MS/s and one cycle has 1000 data points, then the output frequency is 100 kHz. If you change the clock rate to 550 MS/s, then the output frequency changes to 550 kHz.

Do the following steps to set the instrument sample clock rate:

1. Push **SETUP** (front)→**Horizontal** (bottom)→**Clock** (side).
2. Set the value using the general purpose knob, numeric keys, or **SAMPLE RATE/SCALE** knob. If you use a knob, you can use the ◀ or ▶ button to move the cursor to the numeric character you want to change.

When you load the sequence files, the clock rate defined in the first waveform loaded into the instrument sets the instrument clock rate. Changing the instrument output clock rate from the front-panel controls changes the active waveform output frequency but does not change the clock rate stored with that waveform file.

Clock Out The instrument also outputs the internal clock signal to the rear panel VCO OUT (1/4 CLOCK OUT : AWG710) connector. Table 3-5 describes the VCO OUT (1/4 CLOCK OUT : AWG710) signal timing as it relates to the active Run Mode.

NOTE. When you push the RUN button, the instrument outputs a pulse signal for a short period of time on the VCO OUT (1/4 CLOCK OUT : AWG710) connector (not related to the clock signal). This signal is generated for the instrument internal setup.

Table 3-5: Clock signal output timing

Run modes	Timing
Continuous	The clock signal is always output when the RUN LED on the front-panel is on.
Triggered	The clock signal is always output when a waveform is being output. When the instrument waits for a trigger event, no clock output is provided.
Gated	The clock signal is always output when the RUN LED on the front-panel is on.
Enhanced	The clock signal is always output except the instrument is in the trigger wait state.

1/4 Clock Out (AWG710 only)

The instrument outputs the internal clock signal to the rear panel 1/4 CLOCK OUT connector (see Figure 3-3).

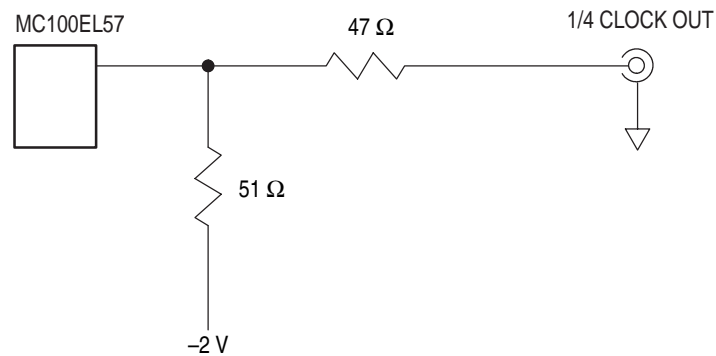

Figure 3-3: 1/4 CLOCK OUT output format

Three connection methods are available. Refer to Figure 3-4.

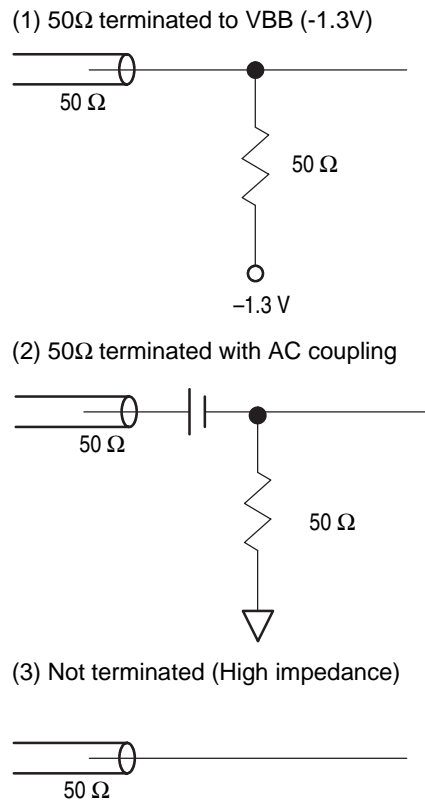

Figure 3-4: 1/4 CLOCK OUT connection examples

Clock Ref This button lets you set the instrument clock source. You can specify the internal clock generator or an external 10 MHz clock signal connected to the rear panel 10 MHz REF IN connector. The acceptable external clock signal is $10\text{ MHz} \pm 0.1\text{ MHz}$, $0.2\text{ V}_{\text{p-p}}$ to $3.0\text{ V}_{\text{p-p}}$.

The instrument synchronizes the internal sample clock phase-lock-loop (PLL) generator to the external clock. Using an external sample clock can help you synchronize the AWG710&AWG710B Arbitrary Waveform Generator with the rest of your test equipment.

If you use the external clock as the reference clock, you can change the output waveform clock rate like the internal clock.

Use the following procedure to select the reference clock source:

1. Push **SETUP** (front)→**Horizontal** (bottom)→**Clock Ref** (side).
2. Push the **Clock Ref** side button to toggle between Internal and External.

NOTE. *If the reference clock signal frequency connected to the 10MHz REF OUT connector is not appropriate, PLL UNLOCKED message will appear when you select External in the Clock Ref menu.*

Clock Src (AWG710B only)

This button lets you set the instrument master clock source. You can specify the internal clock generator or an external clock signal connected to the rear EXTLOCK IN connector. The acceptable external clock signal is 125 MHz to 4.2 GHz, 0.4 V_{p-p} to 2.0 V_{p-p} into 50 Ω, and duty cycle is 50 % ± 5 %.

Use the following procedure to select the clock source:

1. Push **SETUP** (front)→**Horizontal** (bottom)→**Clock Src** (side).
2. Push the **Clock Src** side button to toggle between Internal and External.

NOTE. *If you use the external clock, you can not change the output waveform clock rate with AWG710B Waveform Generator Clock menu or SAMPLE RATE/SCALE knob.*

The Run Mode Menu

Push the **SETUP** on the front-panel and the **Run Mode** bottom button to set the waveform output run mode. The AWG710&AWG710B Arbitrary Waveform Generator operates in response to trigger signals and/or event signals. The Run mode and instrument status (**Stopped**, **Running**, and **Waiting**) are always displayed at the top of screen (see Figure 3-5). The instrument status may not be displayed correctly if the status changes quickly.

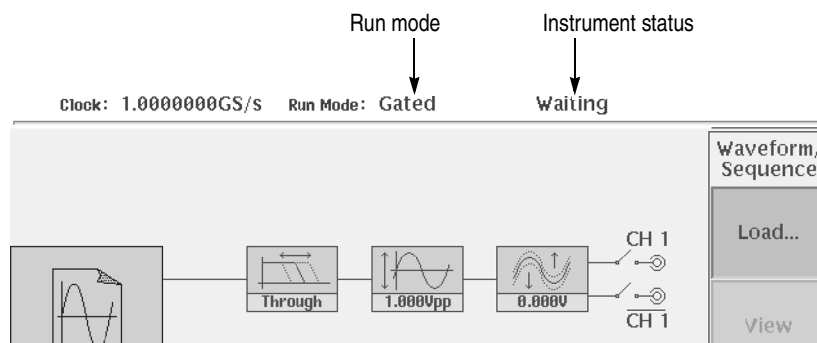

Figure 3-5: Run mode and current status

To specify a run mode, push **SETUP** (front)→**Run Mode** (bottom)→**Continuous**, **Triggered**, **Gated**, or **Enhanced** (side). The following text describes the run modes in more detail.

Continuous This button sets the instrument to continuous output mode. When you push the **RUN** button on the front-panel, the output begins immediately. This occurs regardless of the state of the trigger signal and **FORCE TRIGGER** button on the front-panel. The output starts at the head of the waveform or sequence, and repeats until you push the **RUN** button again. The Status Indicator is displaying **Running** while the waveform is being output, or **Stopped** when the output has been stopped.

Triggered This button sets the instrument to triggered output mode. When you push the **RUN** button on the front-panel, the instrument enters the state awaiting a trigger (the status is **Waiting**). In the state of waiting for trigger, the instrument outputs the head value of waveform or sequence. When the instrument detects trigger or the **FORCE TRIGGER** button is pushed, the output begins at the start of the waveform or sequence data (the status is **Running**). After outputting one waveform or sequence, the instrument outputs the head value of waveform or sequence and enters again the state awaiting another trigger (the status is **Stopped**).

If you push the **FORCE TRIGGER** button or the instrument detects the trigger edge during the waveform/sequence output, these operations are ignored. If you set

number of repetition to Infinite, the signal will continue to output until you push the **RUN** button on the front panel again.

Gated This button sets the instrument to gated output mode. When you push the **RUN** button on the front-panel, the instrument enters the state awaiting a trigger (the status is *Waiting*). In the state of waiting for trigger, the instrument outputs the value of (0 (zero) level + offset). When the trigger signal goes true or you push the **FORCE TRIGGER** button on the front-panel, the output begins at the start of the waveform or sequence data (the status is *Running*).

While the trigger signal is at the true level or the **FORCE TRIGGER** button remains pushed in, the waveform or sequence data is continuously output. When the trigger signal goes false or you release the **FORCE TRIGGER** button on the front-panel, the output stops and the instrument again enters the state awaiting a trigger.

When the trigger source is Internal, the instrument ignores any automatically-generated trigger signals while in the Gated mode.

Enhanced This button sets the instrument to enhanced output mode. While a waveform is being output, the Enhanced mode operates the same as the Triggered mode except for the sequence table output. For sequence table output, the Wait Trigger, Goto <N>, and Jump functions specified in the sequence file are enabled.

Pushing the **RUN** button on the front-panel toggles the output on and off. The trigger signal is used only to advance a sequence in which Wait Trigger is stopping on an ON line. When you push the **FORCE EVENT** button on the front-panel, the instrument operates in the same way as when the Logic Jump event signal goes true.

If the enhanced function is set in the sequence, the output will be as follows:

- **Wait Trigger.** For an ON line, the instrument awaits the trigger before the waveform is output. The selected trigger source (External or Internal) is selected.
- **Goto <N>.** If you enter the number, the control jumps to the specified sequence after the current signal is output.
- **Logic Jump.** When the combination of the event signals connected to the EVENT IN connector on the rear panel goes TRUE during waveform output of the line, the control jumps to the specified destination. This also happens when you push the **FORCE EVENT** button on the front-panel.
- **Table Jump.** During waveform output of the line, the control jumps to the destination specified in the jump table. This depends on the state of the event signal connected to the EVENT IN connector on the rear panel. For Table Jump, the **FORCE EVENT** button will not operate.

- **Software Jump.** During waveform output of any line, the control jumps to the destination specified by the argument of a remote command. The software jump can be performed only with the following command:

AWGControl:EVENT:SOFTWARE[:IMMEDIATE] <line-number>

- If you specify no destination of jump on the last line of the sequence, control returns to the first line after the completion of waveform output. (Goto <N> automatically sets to 1.)

If you push the **RUN** button during the waveform output, the output will stop.

The Trigger Menu

The Trigger menu lets you set instrument external signal trigger parameters. The Trigger menu commands are Source, Slope, Level, Impedance, and Interval.

Pushing the **TRIGGER MENU** button (front panel) displays the Trigger side menu. This has the same effect as pushing **SETUP** (front)→**Trigger** (bottom).

Source This button lets you set the instrument trigger source. You can select either External or Internal.

To set the trigger signal source, push **SETUP** (front)→**Trigger** (bottom)→**Source** (side) to toggle between External and Internal.

If you select External, the instrument uses the signal connected to the rear-panel TRIG IN connector. The external trigger signal must meet the following requirements:

Table 3-6: External trigger signal requirements

Requirement	Values
Input voltage range	±10 V into 1 kΩ impedance ±5 V into 50 Ω impedance
Minimum pulse width	10 ns, 0.2 V amplitude

If you select Internal, the trigger signal generated in the instrument will be used. For the internal trigger, you can set only the trigger interval. In the Gated mode, the internal trigger does not work.

Slope (or Polarity)

This button lets you set the external trigger signal slope (or polarity in the Gated run mode) on which to trigger the instrument. You can select the trigger slope for either the positive-going (rising) or the negative-going (falling) edge (see Figure 3-6).

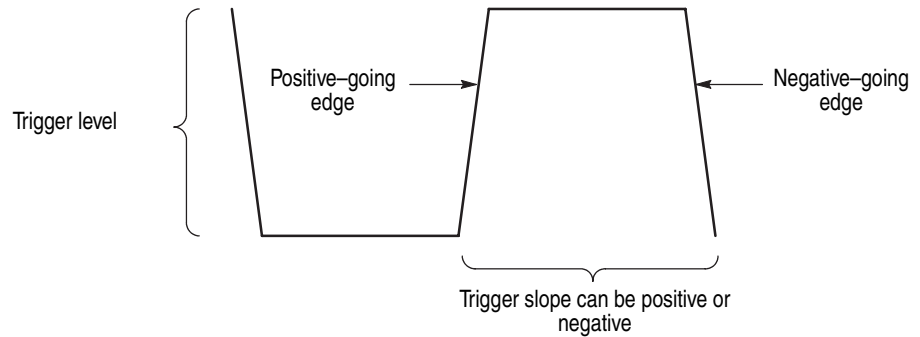

Figure 3-6: Trigger slope and trigger level

To set the trigger slope, push **SETUP** (front)→**Trigger** (bottom)→**Slope** (side) to toggle between Positive and Negative.

NOTE. In the Gated run mode, triggering occurs for the time period that the external trigger signal level is greater than or equal to the specified trigger level setting.

Trigger Level

This button lets you set the level at which the TRIG IN external trigger signal triggers the instrument. You can set the trigger level from -5.0 V to +5.0 V.

Do the following steps to set the signal level:

1. Push **SETUP** (front)→**Trigger** (bottom)→**Level** (side).
2. Use the general purpose knob, numeric buttons, or the keyboard to adjust the trigger level value.

You can set the trigger level with **TRIGGER LEVEL** knob (front) regardless of the Trigger side menu.

Impedance

This button lets you set the impedance value of the TRIG IN back-panel connector. You can set the TRIG IN impedance to either 50 Ω or 1 k Ω .

Do the following to set the TRIG IN back-panel connector input impedance:

1. Make sure that the trigger source is set to External.
2. Push **SETUP** (front)→**Trigger** (bottom)→**Impedance** (side) to toggle between **50 Ω** and **1 k Ω** .

Interval The internal trigger source is a pulse generator that automatically triggers the instrument every interval setting. This button lets you set the time interval between trigger pulses. The time interval ranges from 1.0 μ s to 10.0 s. The automatic trigger interval starts when **RUN** button is pressed.

Do the following steps to set the trigger interval:

1. Push **SETUP** (front)→**Trigger** (bottom)→**Interval** (side).
2. Use the general purpose knob, numeric buttons, or the keyboard to adjust the trigger interval time.

NOTE. The **FORCE TRIGGER** front-panel button forces a trigger event immediately when pressed. Forcing a trigger does not reset the start of the automatic trigger interval. For example, if the trigger interval is set for four seconds, and you force a trigger at 2.5 seconds after the automatic trigger signal seconds, the next automatic trigger occurs 1.5 seconds after the force trigger.

To disable automatic triggering, push **SETUP** (front)→**Trigger** (bottom)→ **Source** (side) to **External**. You can then use an external trigger signal on the **TRIG IN** connector or the **FORCE TRIGGER** front-panel button to trigger the instrument.

The Save/Restore Menu

The Save/Restore menu lets you save and restore instrument output setup information on both AWG mode and FG mode to a file. The setup parameters when saving is included in a setup file. When you restore a setup file, settings in both AWG mode and FG mode will replace the contents of a setup file.

When you output the file after loading it, you need to set the parameters for output because there includes only pattern data and clock information in the waveform and pattern file. The parameters are set in the SETUP main menu.

Setup file includes path information of the waveform file(s) to be set in the Setup Window. When the setup file is saved in the same directory as the waveform file(s), only waveform file name(s) are included in the setup file. Otherwise, the setup file stores the drive and full path information for the waveform file(s).

So you cannot move these files to another directory and/or a drive unless they are stored in the same directory.

Save Setup

This button lets you save the current instrument settings of both AWG mode and Extended operation mode to a file. The instrument appends the extension *.set* to the file name. Do the following steps to save the instrument output setup parameters to a file:

1. Push **SETUP** (front)→**Save/Restore** (bottom)→ **Save Setup** (side). The instrument displays the Select Setup Filename dialog box.
2. Use the general purpose knob or the keyboard to enter a file name.
3. Push the **Drive...** side button if you need to save the setup file to a location other than the current drive.

The setup file must be saved in the same location where the waveform, pattern and/or sequence files currently loaded in the memory are stored.

4. Push the **OK** side button to close the dialog box and save the setup file.

Restore Setup

This button lets you load an instrument setting file to configure the instrument settings. The instrument settings of AWG and Extended operation mode will replace the contents of an instrument setting file. Do the following steps to restore the instrument output setup parameters from a file:

1. Push **SETUP** (front)→**Save/Restore** (bottom)→ **Restore Setup** (side). The instrument displays the Select Setup File dialog box.
2. Use the general purpose knob to select the setup file name.
3. Push the **Drive...** side button to load a setup file from a drive other than the current drive.
4. Push the **OK** side button to close the dialog box and load the setup file. The instrument is set to the configuration specified in the setup file.

NOTE. *If you try to load a nonsetup file, you will get an error message.*



CAUTION. *Bus contentions or collisions may result if shared setup files exist on multiple instruments using one GPIB or bus or one Ethernet subnet. GPIB address and IP addresses are saved and restored with a setup file.*

The Extended Operation Menu

The Extended Operation is the menu which selects FG mode, Waveform Mixing mode, and Synchronous Operation mode from the usual AWG mode.

FG mode Although a standard function waveform can also be outputted as an arbitrary waveform using the standard function waveform in a waveform editor, FG mode which can output a waveform with the same feeling as usual function generator more easily is prepared.

In FG mode, you can output a standard function waveform simply only by setting up fundamental parameters, such as frequency, amplitude, and offset. Refer to the FG mode on page 3-233.

Waveform Mixing mode This mode lets you generate and output the waveform which mixed two waveforms. After you specify two waveform files and mixing ratios to mix, the AWG710&AWG710B generates and outputs a waveform. The generated mixed waveform can be saved as a waveform file. Refer to the Waveform Mixing mode on page 3-241.

Synchronous Operation mode (AWG710B only) The setup screen in the Synchronous Operation mode which performs synchronous operation using two units of the AWG710B is displayed.

Selection of the Sync-Master lets the AWG710B operates as a Master unit.
Selection of the Sync-Slave lets the AWG710B operates as a Slave unit.

Refer to the Synchronous Operation mode on page Figure on page 3-249 .

Waveform, Pattern and Sequence Waveform Output

AWG710&AWG710B Arbitrary Waveform Generator waveforms can be output by selecting a waveform, pattern, or sequence file on the Setup menu screen and loading it into the waveform memory.

You may set the run and trigger modes and the output parameters such as the clock frequency, amplitude, offset and so on. Then, push the **RUN**, **CH1 OUT**, and **ALL MARKER OUT ON/OFF** buttons on the front panel to output the waveforms in the waveform memory. A procedure to output the waveform is outlined below:

1. Push **SETUP** (front)→**Waveform/Sequence** (bottom)→**Load...** (side). Specify the file you want to output.
2. Push **Run Mode** (bottom)→Set the run mode in the side menu.
3. Push **Trigger** (bottom)→Set the trigger parameter in the side menu.
4. Push **Vertical** (bottom)→Set the vertical axis parameters, such as the amplitude, in the side menu.
5. Push **Horizontal** (bottom)→Set the horizontal axis parameters such as the clock frequency in the side menu.
6. Push the **RUN**, **OUTPUT**, and **ALL MARKER OUT ON/OFF** buttons on the front panel.

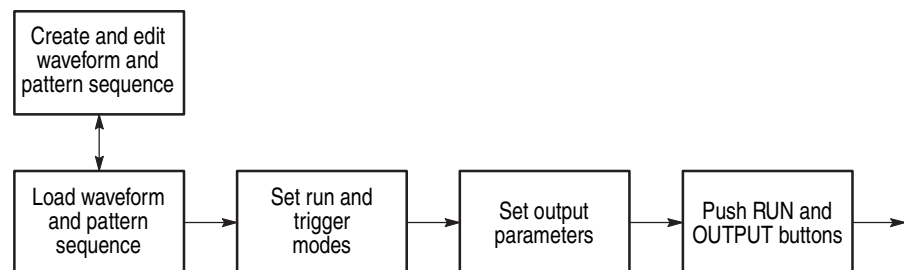

Figure 3-7: Waveform output sequence example

During waveform output, you can make changes to an output parameter using the shortcut controls: **VERTICAL LEVEL/SCALE**, **VERTICAL OFFSET**, and **HORIZONTAL SAMPLE RATE/SCALE**.

Changes you make with the editor during waveform output are shown immediately. Refer to *Edit...* on page 3-37.

Automatic Reloading of Output Files

A file that has been loaded and that is being output will be reloaded when one of the following conditions is met:

- The waveform or pattern file is modified with the editor. (Auto or Manual mode in the Settings bottom menu).
- The file is changed with Copy or Rename by operating the front-panel, GPIB or Ethernet control.
- Changes are made to a sequence file.
- A file is received from GPIB or Ethernet and changes are made to the file.

Auto-reload occurs when changes are made to a file. The file length may change due to Cut or Paste or because it is subjected to Copy as a thoroughly different file. If so, auto-reload will fail and the output file will be named *NULL*.

Waveform Files and Sample Clock Rates

Waveform and pattern files contain the clock attribute values appended. If you specify a waveform or pattern file as the output file, the clock value will be loaded from the file and set.

If you specify a sequence file for the output file, the clock specified in the first file in the sequence list sets the instrument clock rate.

If you load the file as the output file when the following two conditions are met, the waveform in the edit buffer will be loaded:

- You have performed a edit session before loading the output file (while the output file name is *NULL*).
- You have made changes to the waveform data and/or clock attributes whether the file has been saved or not.

Regarding the clock attributes, the values specified in the edit will be loaded.

If the output with the editor is in the **Auto** mode, reload takes place each time changes are made to the edit buffer. The clock attributes are not updated at this time.

When the file is first loaded, the clock attributes are set. Clock changes made with the menu take higher priority over those that are made with the editor by means of the auto-update of the output.

Starting and Stopping Output

When you load or create a waveform in the waveform memory, output does not start until you push the **RUN** button on the front-panel. The RUN LED is on and the instrument starts sweeping the waveform data in the waveform memory.

When the Waveform Generator is set to the Trigger mode, the Waveform Generator waits for a trigger event to be generated by pushing the **FORCE TRIGGER** button or by external trigger event signal. Refer to *The Run Mode Menu* on page 3-44.

The current run state of the instrument is displayed in the status area at the upper part of the screen as shown in Figure 3-5 page 3-44. Refer to Table 3-7 for state messages.

Table 3-7: Instrument run state and state messages

State messages	Descriptions
Stopped	The output operation is currently stopped.
Waiting	The instrument is waiting for a trigger or an event signal.
Running	The instrument is outputting waveform(s).

If waveforms are not present, the *Running* or *Waiting* message will be changed to the Stopped message. There will be no output when you push the **RUN** button and the Stopped message will continue to be displayed.

The RUN LED is on when the run state is *Running* or *Waiting*.

The line circuit from internal generator module to the output connector must be closed to output waveform from the front-panel output connector.

Turning Channel Output On and Off

Push the **CH1 OUT** button to connect or disconnect the instrument output to the CH 1 connector. When you push the CH1 button, the CH1 LED goes on and a waveform is output from the CH1 connector if the instrument is in the Running state. When you push the CH1 button again, the signal output is disconnected and the waveform output is stopped, even if the instrument is in the Running state. If there is no waveform loaded into a channel, you cannot turn that channel output on or off.

The CH1 LED automatically turns off when the waveform data in that channel becomes invalid. For example, you attempt to load an incorrect file, and the instrument deletes the current waveform from memory.

**Turning Marker Output
On and Off (AWG710B
only)**

Push the **ALL MARKER OUT ON/OFF** button to connect or disconnect the instrument marker output to the MKR1 and MKR2 connectors. When you push the **ALL MARKER OUT ON/OFF** button, the **ALL MARKER OUT ON/OFF** LED goes on and marker1 and marker2 signals are output from the MKR1 and MKR2 connector if the instrument is in the Running state. When you push this button again, the marker signals output are disconnected and the marker signal outputs are stopped, even if the instrument is in the Running state. If there is no waveform loaded into a channel, you cannot turn that channel output on or off.

The **ALL MARKER OUT ON/OFF** LED automatically turns off when the waveform data in that channel becomes invalid. For example, you attempt to load an incorrect file, and the instrument deletes the current waveform from memory.



CAUTION. Turn *OFF* the **ALL MARKER OUT ON/OFF** button before connecting/disconnecting a marker cable or turning on/off the power of DUT, in order to prevent the damage to a marker circuit.

NOTE. The *OUTPUT* button and the **ALL MARKER OUT ON/OFF** button are automatically turned off, when the mode of Extended Operation is changed, the Connecting menu of the Synchronous Operation mode is pushed, the Trigger Timing Cal of the Synchronous Operation mode is performed, and when Diag of the *UTILITY* menu is performed.

The Graphical Waveform Editor

This section describes the Graphical Waveform editor. The Graphical Waveform editor lets you create and/or edit an analog waveform. You can choose to display the waveform graphically or in table format. Refer to page 3-105 for information on editing waveform data using a table editor.

Editor Screen Elements

To open a new window for graphical waveform editing, push **EDIT**(front)→**Edit**(bottom)→**New Waveform** (side). Figure 3-8 shows the Waveform Editor screen elements. Table 3-8 describes the editor screen elements. Table 3-9 describes the bottom menu functions. The sections that follow Table 3-9 describe the menu operations in detail.

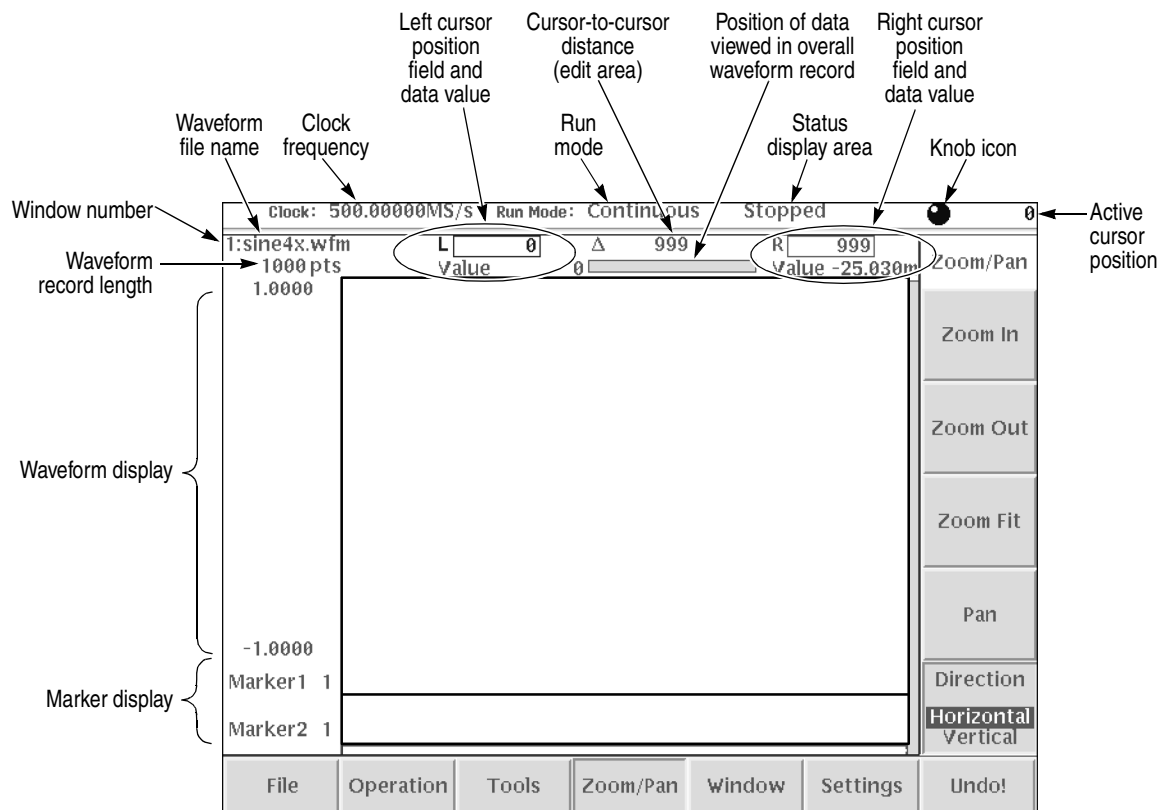

Figure 3-8: Waveform editor initial screen

Table 3-8 provides a description of the Waveform editor screen elements.

Table 3-8: Waveform editor screen elements

Element	Description
Active cursor position	The position of the active cursor in the data record relative to the start of the data record. Position is stated as point location or time depending on the horizontal unit set with the Settings menu.
Clock frequency	The clock frequency (sample rate) used to calculate the point-to-point time interval between each data point. This value is set in the Settings menu. Note that this value is not the output waveform frequency. Output frequency is calculated as follows: $Freq_{out} = Freq_{clk} / \text{points per waveform cycle}$
Cursor-to-cursor distance	The number of data points or time between the left and right cursors. Distance is stated as points or time depending on the horizontal unit set with the Settings menu.
Waveform record length	The record length of the entire waveform file, in points. Record length is always shown as points regardless of the horizontal unit set with the Settings menu. The default value is 1000 points.
Edit area position bar	The edit area position bar is relative to the position of the displayed edit area in the entire record length. This helps you determine where you are in a waveform record when you do zoom operations on the display area.
Window number	The edit window number is from one to three. The maximum number of editor windows you can open at one time is three.
Knob icon	The knob icon is displayed when you can use the general purpose knob to change a highlighted field.
Left cursor position field and data value	The position of the left cursor and the data value at that position. Cursor position 0 is the start of the data record. Position is stated as point location or time depending on the horizontal unit set with the Settings menu. You use the TOGGLE front-panel button to select between the left or right cursor. When the left cursor is active, you can use the general purpose knob or the Keypad buttons to change the cursor position.
Marker display	The marker display is a graphical representation of the marker data values.
Right cursor position field and data value	The position of the right cursor and the data value at that position. Cursor position 0 is the start of the data record. Position is stated as point location or time depending on the horizontal unit set with the Settings menu. You use the TOGGLE front-panel button to select between the left or right cursor. When the right cursor is active, you can use the general purpose knob or the Keypad buttons to change the cursor position.

Table 3-8: Waveform editor screen elements (cont.)

Element	Description
Run mode	The current instrument run mode (Continuous, Triggered, Gated, or Enhanced).
Status display area	The status display area shows the instrument status (Stopped, Running or Waiting).
Waveform display	The waveform display shows a graphical representation of the waveform data values. Refer to the note on page 2-59 for information on the waveform data range.
Waveform file name	The waveform file name is the file name to which the waveform data is written. The Graphical Waveform editor appends the <i>.wfm</i> file extension to all waveform files. If this is a new or modified waveform, you are prompted to save the waveform data to a file name before exiting the editor.

Table 3-9 provides a description of the Waveform editor bottom menus.

Table 3-9: Waveform editor bottom menu

Button	Description
File	Provides commands for opening new waveform or pattern edit windows, inserting data from a file, loading an file, saving edited data to a file, and closing the active editor window. Refer to page 2-17 for information on file management tasks.
Operation	Provides commands for editing and manipulating waveform data, including cutting, copying, pasting, rotating, shifting, creating function generator waveforms, and so on. These commands operate on the data located between the left and right cursors.
Tools	Provides commands to perform mathematical operations on the entire waveform record.
Zoom/Pan	Provides commands to zoom in on, zoom out from, and pan the edit window waveform. You can zoom and pan a waveform horizontally and vertically.
Window	Provides commands to select the active window when more than one edit window is open. Refer to page 3-230 for information on multiple editor windows.
Settings	Displays a dialog box in which to define editor setup parameters including waveform record length, clock frequency, display mode, cursor linking, grid on/off, and so on.
Undo!	Undoes the last edit operation. Undo! is a one-level undo operation. Press Undo! more than once to toggle between the last two operations (the Undo! step itself and the last edit operation).

The File Menu

The File menu controls loading, saving, and insertion of data from the system, floppy disk, or network files. The following sections describe the File menu operations.

New Waveform, New Pattern

The New Waveform, New Pattern command opens a new waveform or pattern editor window. If three editor windows are already open, these commands are unavailable.

Open...

The Open command displays a file name list and side menu that lets you select and load a file.

Save, Save As...

The Save, Save As... command lets you save the active editor waveform data to its currently named file or to a new filename. You must save waveform data to a file before you can output the waveform data. To save a waveform to its current file name, push **File** (bottom)→**Save** (pop-up)→**OK** (side).

If you are saving a waveform for the first time, the instrument opens the Input Filename dialog box, shown in Figure 2-16 on page 2-21. Use this dialog box to enter a file name. If necessary, you can select a different storage media or directory by pushing the **Drive...** side menu button. Enter the file name, then push the **OK** side button or the **ENTER** front-panel button to close the dialog box and save the file.

NOTE. When you exit an editor without saving edited data, the instrument displays the following message Save the changes you made?. Push the **Yes** side button to save the waveform data, or **No** to close the editor without saving the waveform data.

Refer to *Saving Files* on page 2-21 for more information about file saving operation.

Insert From File... You can insert another waveform file into the active editor window. The data is inserted at the active cursor position. Inserting waveform data increases the length of the whole waveform.

Do the following steps to insert waveform data from a file:

1. Move the active cursor to where you want to insert the file data.
2. Push **File** (bottom)→**Insert from File...** (pop-up)→**OK** (side).
3. Select a file from the Select File dialog box.
4. Push the **OK** side button.

The data is inserted at the active cursor position.

Close The Close command closes the active editor window. If you have made edit changes since the last time you saved your waveform data, and you attempt to close the editor window, the instrument displays the message *Save the changes you made?*. Push the **Yes** side button to save the waveform data. If you have not made any edit changes since the last time you saved the file, the instrument closes the editor window and redraws the screen to display the remaining editor windows. If you only have one editor window open and close that window, the instrument returns you to the EDIT main screen.

The Operation Menu

The **Operation** bottom button provides waveform data edit commands. The following sections describe each edit command in detail.

If you select a command with an ellipsis (...), the instrument displays either a side menu or dialog box that lets you set additional parameters. Commands that do not have ellipses are executed immediately.

Standard Waveform This command creates standard waveforms such as sine and triangle waves in the edit area. The edit area is the area between the cursor positions. Do the following steps to create a standard waveform:

1. Move the cursors to specify the edit area where the function waveform will be created.
2. Push **Operation** (bottom)→**Standard Waveform...** (pop-up).
The Set Standard Function dialog box as shown in Figure 3-9 is displayed. Table 3-10 describes the dialog box field functions.
3. Set the required parameters and the push the **OK** side button.

The instrument replaces, inserts, adds, or multiplies the edit area with the specified standard waveform data.

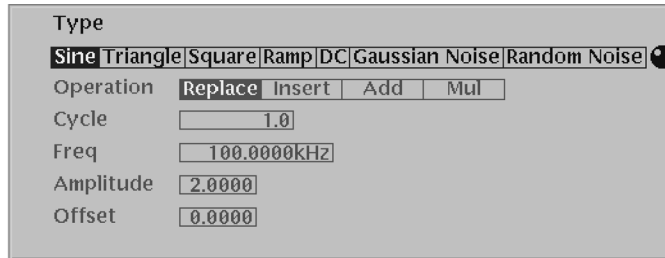

Figure 3-9: Standard Function Waveform dialog box

Table 3-10: Standard Function Waveform dialog box parameters

Parameter	Description
Type	Specifies the type of standard function waveform to create. You can select Sine, Triangle, Square, Ramp, DC, Gaussian Noise, or Random Noise.
Operation	<p>Selects how the standard function waveform is added to the edit area.</p> <p>Replace replaces the edit area data with the specified standard function waveform. This operation does not change the waveform data record length.</p> <p>Insert inserts the standard function waveform at the active cursor position. This operation increases the waveform data record length by the amount of the inserted waveform.</p> <p>Add replaces the edit area data with the sum of the current edit area data and the specified standard function waveform. This operation does not change the waveform data record length.</p> <p>Mul replaces the edit area data with the product of the current edit area data and the standard function waveform. This operation does not change the waveform data record length.</p>
Cycle	<p>Specifies the number of function waveform cycles to insert in the specified cursor area. The range of values is from 0.1 to 100,000 in 0.000001 to 0.001 increments. The default value is 1 cycle.</p> <p>If the Operation field is set to Replace, Add, or Mul, the Cycle field value determines the Frequency field value according to the equation $Frequency = Cycle \times clock\ frequency / data\ length$</p>
Frequency	<p>Specifies the frequency of the function waveform to insert in the specified cursor area. The range of values is from 0.1 Hz to 500 MHz, with 9-digit accuracy.</p> <p>If the Operation field is set to Replace, Add, or Mul, the Frequency field determines the Cycle field value according to the equation $Cycle = Frequency \times data\ length / clock\ frequency$</p>

Table 3-10: Standard Function Waveform dialog box parameters

Parameter	Description
Amplitude, or RMS	Specifies the standard function waveform's DAC range. The range of values is from -2.0 to 2.0 in 0.0001 increments. Specifying a negative value creates a waveform whose first cycle starts with a negative transition (in other words, a 180° phase shift). Refer to the note on page 2-59 for more information on DAC values. If you selected Gaussian Noise, this parameter turns to RMS. You can use Root Mean Square to specify the signal amplitude.
Offset	Specifies the function waveform offset value. The range of values is from -1.0 to 0.0 in 0.0001 increments. The default offset is 0.

Cut The Cut command deletes the edit area waveform and marker data and places the deleted data in the paste buffer. The waveform data length decreases by the amount of data deleted. If you unintentionally delete data, you can use the Undo! bottom button to undo the cut operation.

Copy The Copy command copies the waveform and marker data located between the cursors and places the copied data in the paste buffer. The overall waveform data record length does not change.

Paste (Insert) The Paste (Insert) command inserts the contents of the paste buffer into the waveform record at the active cursor position. The data to the right of the active cursor shifts to the right by the number of data points inserted. The overall waveform data record length increases by the number of data points inserted. If the paste buffer is empty, this command is ignored.

Paste (Replace) The Paste (Replace) command inserts the contents of the paste buffer into the waveform record at the active cursor position. The data to the right of the active cursor is replaced with the number of data points inserted. The overall waveform data record length is unchanged. If the paste buffer is empty, this command is ignored.

Multiple Paste... The Multiple Paste... command inserts the contents of the paste buffer a specified number of times into the waveform record at the active cursor position. The data to the right of the active cursor shifts right by the number of data points inserted. The overall waveform data record length increases. If the paste buffer is empty, this command is ignored.

Do the following steps to do a multiple paste operation:

1. Move an active cursor to the location in the waveform record where you want to insert the data.

2. Push **Operation** (bottom)→**Multiple Paste** (pop-up)→**OK** (side).

The instrument displays a dialog box in which you can enter the number of times to insert the paste buffer contents.

3. Set the paste count by using the numeric buttons or the general purpose knob.

4. Push the **OK** side button.

The contents of the paste buffer are inserted the specified number of times at the active cursor position.

Set Data High/Low

The Set Date High/Low command sets all Marker 1 or 2 values that are between the two cursors to High or Low. Do the following steps to set the marker values:

1. Move the cursors to specify the edit area that you want to change.

2. Push **Operation** (bottom)→**Set Data High/Low** (pop-up)→**OK** (side).

3. Push the **Marker 1** or **Marker 2** side button to select the marker.

4. Push the **Set Data** side button to toggle between High and Low value.

5. Push the **Exec** side button to change the marker specified in Step 3 to the value specified in Step 4 for the entire edit area.

Horizontal Shift...

The Horizontal Shift... command shifts the edit area data to the left or right by the specified value (points or time), within the cursor area. A positive value shifts data to the right, and a negative value shifts data to the left. All data that is shifted past the left or right cursor is truncated. The opposite, blanked field is padded with the initial cursor point values. This command can only shift one type of data (waveform, Marker 1 or Marker 2) at a time.

Do the following steps to horizontally shift the waveform or the marker data:

1. Move the cursors to specify the edit area of data to shift.

2. Push **Operation** (bottom)→**Horizontal Shift** (pop-up)→**OK** (side).

3. Push the **Data**, **Marker1**, or **Marker2** side button to select the data you want to shift.

4. Push the **Point** (or **Time**) side button.

Use the general purpose knob or numeric keys to specify the amount of shift. A positive value shifts data to the right, and a negative value shifts data to the left.

5. Push the **Exec** side button to shift the part specified in step 3 by the amount specified in step 4.

Horizontal Rotate...

The Horizontal Rotate... command rotates the edit area data to the left or right by the specified value (points or time), within the cursor area. A positive value shifts data to the right, and a negative value shifts data to the left. All data that is shifted past the left or right cursor is rotated to the opposite cursor. This command can only shift one type of data (waveform, Marker 1 or Marker 2) at a time.

Do the following steps to horizontally rotate waveform or marker data:

1. Move the cursors to specify the edit area to shift.
2. Push **Operation** (bottom)→**Horizontal Rotate** (pop-up)→**OK** (side).
3. Push the **Data**, **Marker1**, or **Marker2** side button to select the data you want to shift.
4. Push the **Point** (or **Time**) side button. Use the general purpose knob or numeric keys to specify the amount of shift. A positive value shifts data to the right, and a negative value shifts data to the left.
5. Push the **Exec** side button to shift the part specified in step 3 by the amount specified in step 4.

Vertical Shift...

The Vertical Shift... command shifts the cursor-to-cursor waveform data up or down the value specified with Value. If Value is positive, the data shifts up; if Value is negative, the data shifts down. The editor retains values that exceed the default ± 1.0 waveform peak-to-peak range. You can use the Zoom or Pan commands to view data that is out of the waveform display range. You can only vertically shift waveform data; you cannot vertically shift marker data.

Do the following steps to vertically shift waveform data:

1. Move the cursors to specify the edit area to shift.
2. Push **Operation** (bottom)→**Vertical Shift** (pop-up)→**OK** (side).
3. Push the **Value** side button. Specify the amount of shift using the general purpose knob or numeric buttons. A positive value shifts data up, and a negative value shifts data down.
4. Push the **Exec** side button to shift the waveform by the amount you specified in Step 3.

Expand... The Expand... command horizontally expands (scales) the edit area waveform and marker data by a specified amount in the range of 2 to 100. Expansion starts at the left cursor position. All data in the edit area expands as required for the amount of expansion.

1. Move the cursors to specify the edit area to expand.
2. Push **Operation** (bottom)→**Expand...** (pop-up)→**OK** (side).
3. Push the **By** side button. Specify the amount of expansion by using the general purpose knob or numeric buttons. You may specify any integer from 2 to 100.
4. Push the **Exec** side button to expand the edit area data starting at the left cursor position.

Vertical Scale... The Vertical Scale... command vertically shrinks or expands the edit area waveform data by a specified factor value, around a specified origin value. The Factor value range is -100 to 100 in 0.01 increments. The Origin value range is -1 to 1 in 0.0001 increments.

Do the following steps to vertically scale the waveform data:

1. Move the cursors to specify the edit area to scale.
2. Push **Operation** (bottom)→**Vertical Scale...** (pop-up)→**OK** (side).
3. Push the **Factor** side button.

This is the value by which you want to multiply the edit area waveform data. Specify the scale using the general purpose knob or the numeric buttons. A negative value of -100 to -1.01 inverts and rescales the signal. A value from -1 to -0.01 inverts and reduces signal vertical values.

4. Push the **Origin** side button.

Specify the center of scale using the general purpose knob or the numeric buttons.

5. Push the **Exec** side button.

The cursor-to-cursor data vertically expands or shrinks with the center at the Origin position.

Horizontal Invert... The Horizontal Invert... command horizontally inverts (flips) the edit area waveform and marker data. You can invert the waveform and marker data separately. This command does not change the waveform data record length.

Do the following steps to horizontally invert the waveform or marker data:

1. Move the cursors to specify the edit area to invert.
2. Push **Operation** (bottom)→**Horizontal Invert...** (pop-up)→**OK** (side).
3. Push the **Data**, **Marker1**, or **Marker2** side button to specify which data to invert.
4. Push the **Exec** side button.

The data in the edit area inverts (flips) horizontally.

Vertical Invert... The Vertical Invert... command vertically inverts (flips) the edit area waveform and marker data. You can invert the waveform and marker data separately. This command does not change the waveform data record length.

Do the following steps to vertically invert the waveform or marker data:

1. Move the cursors to specify the edit area to invert.
2. Push **Operation** (bottom)→**Vertical Invert...** (pop-up)→**OK** (side).
3. Push the **Data**, **Marker1**, or **Marker2** side button to specify which data to invert.
4. Push the **Exec** side button to vertically invert the cursor-to-cursor data you have specified in Step 3.

Clip... The Clip... command sets the edit area waveform data maximum upper or lower signal level to a specified value.

Do the following steps to clip the waveform data:

1. Move the cursors to specify the edit area to clip.
2. Push **Operation** (bottom)→**Clip...** (pop-up)→**OK** (side).
3. Push the **Clip** side button to specify the portion of level to be clipped. Select either the **Upper** or **Lower**. Upper refers to all signal data located above the origin, and lower refers to all signal data located below the origin.
4. Push the **Level** side button and specify the clip level using the general purpose knob or numeric keys.
5. Push the **Exec** side button to clip the waveform data.

Shift Register Generator...

The Shift Register Generator... command specifies a shift register to generate pseudo-random pulses with the value of 1 or 0 that replace the waveform data in the edit area. The pseudo-random shift generator consists of a user-definable register size (1 to 32 bits) and a user-specified number of feedback taps that do an XOR operation between a specified register bit and the register output.

NOTE. *XOR (exclusive OR) is a boolean logic operation that outputs one if two input values are different and outputs 0 otherwise.*

Figure 3-10 shows an example of the pattern generated for a 3-bit register with an initial value of 101 and a single tap on register bit 2.

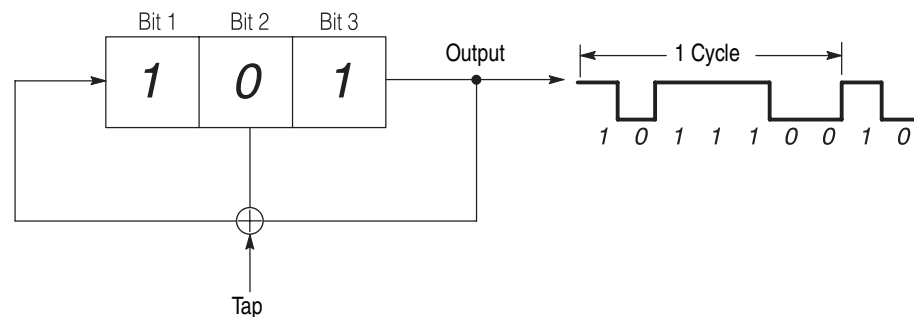

Figure 3-10: Register value and tap setting example

The following steps describe how the instrument generates the output waveform values.

1. Output 1 of the rightmost bit.
2. Take XOR of the output value 1 and the Bit 2 value 0 (result is 1).
3. Shift the bit values one column to the right.
4. Assign the value 1 to Bit 1, which is the XOR value from Step 2. The new array of the register values is 110.
5. Repeat steps 1 to 4, with 110 as the register value.
6. Repeating output of the rightmost bit of the register and the subsequent shift of the register value results in the output values as shown in Figure 3-10. In this example, the shift register output pattern starts to repeat after seven cycles.

The data generated by the shift register is called an M Series. If n is defined as the number of shift register bits, then the output pattern from the shift register generator (M Series length) will begin to repeat after $2^n - 1$ cycles.

The Shift Register Generator dialog box lets you define the register length, initial register bit values, and XOR tap bits used to generate pseudo-random pulses. Figure 3-11 shows the dialog box, and Table 3-11 describes the dialog box parameters.

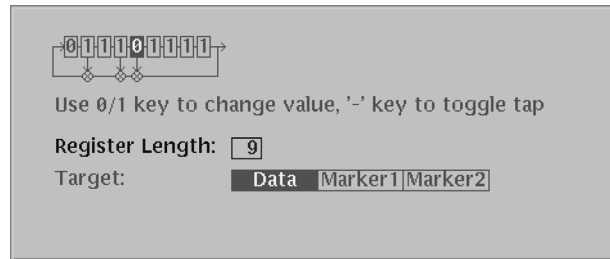

Figure 3-11: Shift Register Generator dialog box

Table 3-11: Shift Register Generator dialog box setting parameters

Parameter	Description
Register Icon	The Register Icon displays the current register length and tap position values at the top left side of the dialog box.
Register Length	Specifies the register length. Set a value from 1 to 32 using the general purpose knob or numeric buttons. The graphic register image in the dialog box will change to show the number of registers you enter.
Target	Specifies the location where the generated pseudo-random pulse data is created. Selecting Data replaces the waveform data. Selecting Marker1 or Marker2 replaces the marker data. If the register data has fewer data points than those in the edit area, the register output repeats until the end of the edit area.

Do the following steps to generate a set of pseudo-random pulses:

1. Move the cursors to specify the edit area to replace with the pseudo-random signal.
2. Push **Operation** (bottom)→**Shift Register Generator...** (pop-up)→**OK** (side).

The Shift Register Generator dialog box appears.

3. Specify a register length in the Register Length field.

The graphical register icon at the top of the dialog box redraws to show the number of registers entered in the Register Length field. The value can be 0 to 32.

4. Specify the register tap position(s) by selecting the register graphic icon. Use the ◀ or ▶ buttons to move the cursor to the desired tap position, and then push the - button to set the tap at the cursor position.

You can also use the Maximum Length Setting side button to automatically set the tap positions to maximize the length of the random waveform data sequence.

5. Select **Data**, **Marker1**, or **Marker2** in the **Target** field to specify the waveform data type to replace with the register output.
6. If desired, enter the initial register bit pattern values in the register graphic icon at the top of the dialog box.

You can also use the Set All Registers side menu to set all register bits to one.

7. Push the **OK** side button to generate the cursor-to-cursor pseudo-random pattern in the area specified in Target.

Set Pattern...

The Set Pattern... command replaces existing edit area waveform data with 0 or 1 data values that you specify. You can also use this command to copy the pattern data from one editor window and replace it in another editor window. If the pattern you enter has fewer data points than those in the edit area, the pattern repeats until the end of the edit area. This command does not change the waveform data record length. Selecting Set Pattern opens the Set Pattern dialog box, shown in Figure 3-12.

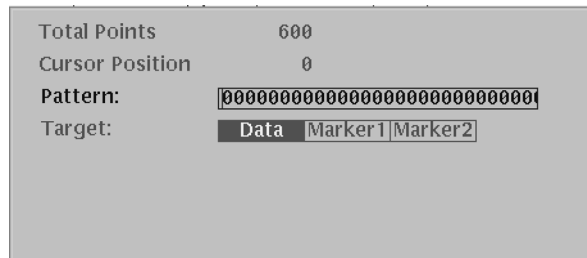

Figure 3-12: Set Pattern dialog box

Table 3-12: Set Pattern dialog box parameters

Parameter	Description
Total Points	Displays the number of data points entered in the Pattern field. The instrument updates this value as you change the pattern data in the pattern field.
Cursor Position	Displays the cursor position in the pattern field. The instrument updates this value as you change the cursor position in the Pattern field.
Pattern	Specifies the pattern field value. Enter the pattern data by using the 0 or 1 numeric buttons on the front panel or from an attached keyboard. Push the Clear Pattern side button to clear the pattern data field. Push the Import Pattern side button to insert the edit area pattern data from the active window target data type into the pattern field. You can then write the pattern data to a target waveform type in the active window or another window.
Target	Specifies the location where the generated data is created or the source for imported pattern data. If you specify Data, the pattern data replaces edit area waveform data; if Marker1 or Marker2 is selected, the pattern data replaces the edit area marker data. To import the pattern from the Target specified here, use the Import Pattern side menu.

Do the following steps to specify a pattern:

1. Move the cursors to specify the edit area in which to replace the waveform data with pattern data.
2. Push **Operation** (bottom)→**Set Pattern...** (pop-up)→**OK** (side).
The Set Pattern dialog box appears.
3. Select **Data**, **Marker1**, or **Marker2** to specify the target data type to replace with the pattern data.
4. Define the pattern using numeric buttons, or push the **Import Pattern** side button to import the pattern data.
5. If necessary, you can change the pattern value by moving the cursor with the **◀** or **▶** button and then using numeric keys and the **←** key.
6. Push the **OK** side button to replace the waveform or marker data with the specified pattern data.

The Import Pattern function lets you read waveform or pattern data from the specified target data type of the active window and stores it in the pattern buffer. You can then replace waveform or marker data with the pattern data in the current window or another window. The Set Pattern dialog box converts all waveform data greater than 0.5 volts to a one level if the waveform data is analog T. All waveform data less than or equal to 0.5 volts is set to a zero level.

Do the following steps to use the Import Pattern function to convert waveform data into pattern data:

1. Move the cursors to specify the edit area from which to import the waveform pattern data.

2. Push **Operation** (bottom)→**Set Pattern...** (pop-up)→**OK** (side).

The Set Pattern dialog box appears.

3. Select **Data**, **Marker1**, or **Marker2** to specify the data type from which to import the pattern data.

4. Push the **Import Pattern** side button to import the pattern data.

All waveform data above 0.5 becomes a one pattern value, and all waveform data at or below 0.5 becomes a zero pattern value. The pattern data is stored in the pattern buffer.

5. Select **Data**, **Marker1**, or **Marker2** to specify the data type to replace with the pattern data.

6. Push the **OK** side button to replace the waveform or marker data with the specified pattern data.

Do the following steps to write pattern data between different editor windows:

1. Move the cursors to specify the edit area from which to import the waveform pattern data.

2. Push **Operation** (bottom)→**Set Pattern...** (pop-up)→**OK** (side).

The Set Pattern dialog box appears.

3. Select **Data**, **Marker1**, or **Marker2** to specify the data type from which to import the pattern data.

4. Push the **Import Pattern** side button to import the pattern data.

All waveform data above 0.5 becomes a one pattern value, and all waveform data at or below 0.5 becomes a zero pattern value. The pattern data is stored in the pattern buffer.

5. Push the **Cancel** side button.

This cancels the Set Pattern dialog box but retains the pattern data in the pattern buffer.

6. Open or make active the other editor window.
7. Move the cursors to specify the edit area in which to replace the existing data with the pattern data.

8. Push **Operation** (bottom)→**Set Pattern...** .

The Set Pattern dialog box appears, with the pattern field displaying the pattern data from the other editor window.

9. Select **Data**, **Marker1**, or **Marker2** to specify the target data type to replace with the pattern data.

10. Push the **OK** side button to replace the waveform or marker data with the specified pattern data.

Numeric Input...

The Numeric Input... command lets you change the waveform or marker data value at the active cursor location. You can use the numeric buttons or the general purpose knob to change the waveform data value.

Do the following steps to change the numeric value of the data at the active cursor position:

1. Move a cursor to the data point that you want to change.
2. Push **Operation** (bottom)→**Numeric Input...** (pop-up)→**OK** (side).
3. Push the **Data** side button and use the general purpose knob or numeric keys to set the waveform data value.
4. Push the **Marker1** or **Marker2** button to toggle between the marker values.

NOTE. *The values modified through the side menu are immediately shown in the data. Use the general purpose knob after the value has been modified. Push Undo! to return to the previous value prior to modification.*

The Tools Menu

The Tools menu performs mathematical operations on the entire waveform data record you are currently editing. There are two mathematical operations:

- Single Waveform Math, which performs the specified mathematical operation on the currently edited waveform.
- Dual Waveform Math, which performs a specified mathematical operation between the currently edited waveform and a different waveform.

The math operations do not change the marker data.

The math waveform operations apply to the whole waveform rather than merely the edit area. The waveform math commands opens a new window that contains the waveform data that is the result of the math operation. The operation uses the values of the points on the waveform or waveforms for input, and performs the operation, point by point, to generate the results.

NOTE. *If you perform a math operation that needs to create a new window, and there are three windows already open, the math command displays an error message.*

If a math operation creates a waveform with values greater than ± 1.0 , you can use the Zoom/Pan (bottom) commands to view the part of waveform that lies outside the window. The instrument retains the calculated values even if they exceed the current editor settings. Use the **Normalize** command to scale the signal values to a ± 1.0 DAC range.

For Dual Waveform Math, there may be a mismatch between the data lengths of the two input waveforms. The output waveform's data length will equal the shorter of the two compared waveforms.

Table 3-13 lists the waveform math commands along with the equation used to calculate the new waveform data. Information regarding more complicated commands follow Table 3-13.

Table 3-13: Mathematical function commands

Command	Equation ¹	Description
Absolute	$G(x) = F1(x) $	Creates a new waveform that is the absolute value of the points in the source waveform.
Square	$G(x) = (F1(x))^2 : F1(x) \geq 0$ $G(x) = - (F1(x))^2 : F1(x) < 0$	Creates a new waveform that is the squared value of the points in the source waveform.
Cube	$G(x) = (F(x))^3$	Creates a new waveform that is the cubed value of the points in the source waveform.

Table 3-13: Mathematical function commands (cont.)

Command	Equation ¹	Description
Square Root	$G(x) = \sqrt{F1(x)} \mid : F1(x) \geq 0$ $G(x) = -\sqrt{F1(x)} \mid : F1(x) < 0$	Creates a new waveform that is the square root value of the points in the source waveform.
Normalize		Scales the active editor window signal values to a ± 1.0 range, centered on 0. This command makes changes to the active editor window data values.
Differential	$G(x) = d/dx F1(x)$	Creates a new waveform that is the differentiation of the points in the source waveform. Refer to page F-1 for the differentiation algorithm.
Integral	$G(x) = \int F1(x)$	Creates a new waveform that is the integral value of the points in the source waveform. Refer to page F-3 for the integration algorithm.
Add	$G(x) = F1(x) + F2(x)$	Creates a new waveform that is the sum of the active window and a nonactive window data points. There are no restrictions on the data lengths of the two source waveforms. The data length of the resultant is equal in length to the shortest of the source waveforms.
Sub	$G(x) = F1(x) - F2(x)$	Creates a new waveform that is the subtraction of the active window and a nonactive window data points, starting a data position 0. There are no restrictions on the data lengths of the two source waveforms. The data length of the resultant waveform is equal in length to the shortest of the source waveforms.
Mul	$G(x) = F1(x) \times F2(x)$	Creates a new waveform that is the multiplication of the active window and a nonactive window data points. There are no restrictions on the data lengths of the two source waveforms. The data length of the resultant waveform is equal in length to the shortest of the source waveforms.

Table 3-13: Mathematical function commands (cont.)

Command	Equation ¹	Description
Compare...		<p>Creates a new waveform that is the comparison of the active window and a specified window data points. Refer to page 3-75 for information on the Compare dialog box.</p> <p>There are no restrictions on the data lengths of the two source waveforms. The resultant waveform's data length is equal in length to the shortest of the source waveforms. You can also set comparison hysteresis levels.</p> <p>Standard Compare. The new waveform consists of logical 0 and 1 values. If the source level exceeds the reference signal level, the comparison result is a one. If the source level is less than the reference signal level, the comparison result is a 0. See Figure 3-13.</p> <p>Hysteresis Compare. The new waveform consists of logical zero and 1 values. If the source level exceeds the reference signal level by the specified hysteresis amount, the comparison result is a one. If the source level is less than the reference signal level by the specified hysteresis amount, the comparison result is a zero. See Figure 3-13.</p>
Convolution...		<p>Creates a new waveform that is the convolution value of the points in the source waveform. Refer to page 3-76 for information on the Convolution dialog box. Refer to page F-4 for the convolution algorithm.</p>
Correlation...		<p>Creates a new waveform that is the correlation value of the points in the source waveform. Refer to page 3-77 for information on the Correlation dialog box. Refer to page F-5 for the correlation algorithm.</p>
Digital Filter...		<p>Creates a new waveform by applying a user-defined digital filter to the source waveform data values. Refer to page 3-78 for information on the Digital Filter dialog box.</p>
Re-Sampling...		<p>Changes the active editor window clock frequency or data record length (number of points). This command changes the data values of the entire waveform record in the active editor window. Refer to page 3-79 for information on the Re-sample dialog box.</p>

Table 3-13: Mathematical function commands (cont.)

Command	Equation ¹	Description
XY View...		Displays the XY view of two waveforms. The XY view dialog box is an information display and does not alter the waveform data. Waveform XY view. Refer to page 3-80 for information on the XY View dialog box.

¹ **F1: Source waveform of active window**
F2: Source waveform of nonactive window
G: Waveform resulting from operation
(x): Waveform data point value

Compare... Figure 3-13 shows an example of the output of standard and hysteresis comparison operations. The rectangular wave is the reference waveform, and the triangular wave is the source waveform.

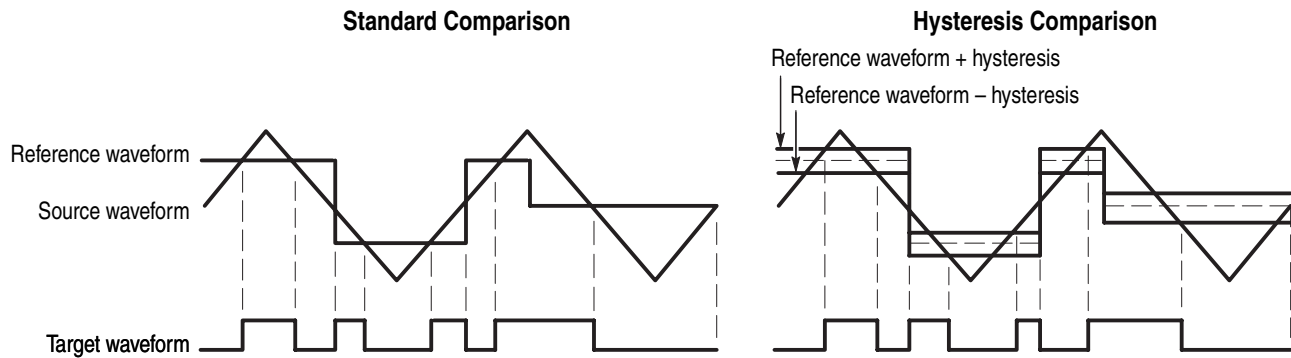

Figure 3-13: Waveform compare operation example

Compare Dialog Box. The Compare dialog box lets you set the target and source waveform and hysteresis values. Table 3-14 describes the Compare dialog box parameters.

Table 3-14: Compare dialog box parameters

Parameters	Descriptions
Target	Specifies the location where you want to display the result of operation. Options are Data, Marker 1 and Marker 2.
With	Specifies the reference waveform.
Hysteresis	Specifies the amount of hysteresis. The value may be -1 to 1 in 0.0001 increments.

Do the following steps to do a comparison math operation between two waveforms:

1. If more than one window is open, select the source waveform as follows:
Push **Window** (bottom)→**Window1**, **Window2**, or **Window3** (side).
2. Push **Tools** (bottom)→**Compare...** (pop-up)→**OK** (side).
The Compare dialog box appears.
3. Push either **Data**, **Marker1** or **Marker2** in the Target to specify the location where you want to create the data.
4. Select the reference waveform in the With field.
5. Specify the amount of hysteresis in the Hysteresis field.
6. Push the **OK** side button to generate a pattern in the target edit area.

This pattern shows the result of the compare process.

Convolution...

The Convolution... command performs convolution for the active window's and a nonactive window's waveforms and displays the result in the third window. There are no restrictions on the data lengths of the two waveforms. For markers, the value of current window is copied. If one or three windows are open, the operation will not work.

Refer to *Convolution* on page F-4 for more information about convolution and examples.

Convolution Dialog Box. The Convolution dialog box lets you set the second waveform for the operation and the Periodic On/Off toggle. Table 3-15 describes the Convolution dialog box parameters.

Table 3-15: Convolution dialog box parameters

Parameters	Descriptions
With	Specifies the second waveform for the operation.
Treat waveform periodic	Specifies whether the waveform must be regarded as periodic during calculation.

Do the following steps to perform a convolution math operation between two waveforms:

1. If more than one window is open, select the source waveform as follows:
Push **Window** (bottom)→**Window1**, **Window2**, or **Window3** (side).

2. Push **Tools** (bottom)→**Convolution...** (pop-up)→**OK** (side). The Convolution dialog box appears.
3. Select the second waveform in the With field.
4. Select either **Off** or **On** in the Treat waveform as periodic field.
5. Push the **OK** side button to generate the result of convolution of the two waveforms.

Correlation... The Correlation... command performs correlation between the data points in the active window and the data points in a nonactive window, starting at data point 0. The results are displayed in a third window. There are no restrictions on the data lengths of the two waveforms. For markers, the value of current window is copied. If one or three windows are open, the operation will not work.

Refer to *Correlation* on page F-5 for more information on correlation.

Correlation Dialog Box. The Correlation dialog box lets you set the second waveform for the operation and the Periodic On/Off switch. Table 3-16 describes the Correlation dialog box parameters.

Table 3-16: Correlation dialog box parameters

Parameters	Descriptions
With	Specifies the second waveform for the operation.
Treat waveform periodic	Specifies whether the waveform must be regarded as periodic during calculation.

Do the following steps to perform a correlation math operation between two waveforms:

1. If more than one window is open, select the source waveform as follows:
Push **Window** (bottom)→**Window1**, **Window2**, or **Window3** (side).
2. Push **Tools** (bottom)→**Correlation...** (pop-up)→**OK** (side).
The Correlation dialog box appears.
3. Select the second waveform in the With field.
4. Select either **Off** or **On** in the Treat waveform as periodic field.
5. Push the **OK** side button to generate the result of correlation of the two waveforms.

Digital Filter... The Digital Filter... command applies a digital filter to the whole of the active window's waveform and displays the result in another window. If three windows are open, the operation will not work.

The digital filter implemented in this instrument is composed of n FIR filter and Kaiser window functions, where n represents the number of delay elements that composes the filter. You can specify the n as a tap that varies from 3 to 101. The larger the value of n (number of taps), the greater the filtering capability. However, filtering will take a longer time to perform as the value of n increases.

Digital Filter Dialog Box. Figure 3-14 shows the Digital Filter dialog box. Table 3-17 describes the digital filter parameters.

Applying the digital filter results in delay by $(\text{number of taps} - 1)/2$. The original data is regarded as an iterative waveform during calculation. As a result of the delay due to the filter, the portion around the start of the output waveform is influenced by the end of the input waveform.

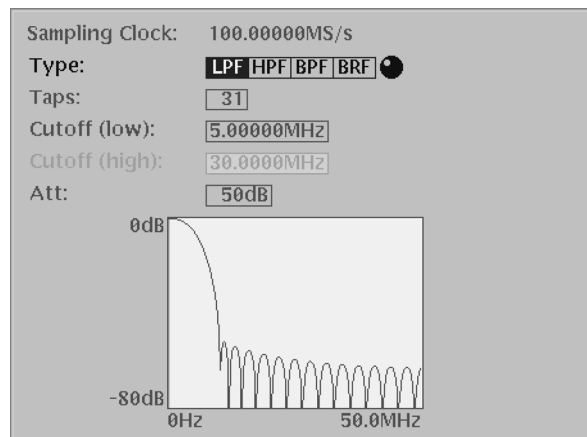

Figure 3-14: Digital Filter dialog box

Table 3-17: Digital filter dialog box parameters

Parameters	Descriptions
Type	Selects the filter type. You can select LPF (low pass filter), HPF (high pass filter), BPF (band pass filter), or BRF (band rejection filter).
Taps	Specifies the number of taps (odd number, 3 to 101).
Cutoff	Specifies the cutoff frequency. If you selected BPF or BRF, you must specify the upper and lower bandpass limits.
Att	Specifies the attenuation of the inhibited bands (21 to 100, in dB increments).

Do the following steps to digitally filter a waveform:

1. If more than one window is open, select the source waveform as follows:
Push **Window** (bottom)→**Window1**, **Window2**, or **Window3** (side).
2. Push **Tools** (bottom)→**Digital Filter...** (pop-up)→**OK** (side).
The Digital Filter dialog box appears.
3. Select the second waveform in the Type field.
4. Specify the number of taps in the Taps field.
5. Specify the cutoff frequency in the Cutoff field.
6. Specify the attenuation of the inhibited band in the Att field.
7. Push the **OK** side button to generate a waveform by applying the active waveform to the digital filter.

Re-sampling...

The Re-sampling... command enables you to specify a new clock frequency or a new number of points. It resamples and updates the whole waveform data record in the active window.

Re-sampling Dialog Box. The current number of points and the current sample clock frequency are in the top display. You should set the new number of points or sample clock frequency at the bottom. The number of points and the sample clock frequency are dependent on each other.

Table 3-18: Re-sampling dialog box parameters

Parameters	Descriptions
New Points	Specifies the new number of sample points.
New Clock	Specifies the new sample clock frequency.

Do the following steps to resample a waveform:

1. If more than one window is open, select the source waveform as follows:
Push **Window** (bottom)→**Window1**, **Window2**, or **Window3** (side).
2. Push **Tools** (bottom)→**Re-Sampling...** (pop-up)→**OK** (side).
The Re-sampling dialog box appears.
3. Set a value in either the New Points or the New Clock.

4. Push the **OK** side button to update the current window with the waveform that resulted from resampling with the above specified sample clock frequency.

Code Convert...

The Code Convert... command can be applied to the waveform data and marker data. The code convert function inputs a 01 pattern. When you select waveform data as the input source, the input data is considered to be 1 when the point values are equal to or larger than 0.5 and 0 when the point values are less than 0.5.

For the details on the code conversion, refer to *The Tools Menu* on page 3-87 and to *Code Conversion* on page F-7.

XY View...

The XY View... command displays the XY view of two waveforms. The XY view dialog box is an information display and does not alter the waveform data.

The XY View dialog box, shown in Figure 3-15, lets you specify the waveforms you want to display in the XY view. Table 3-19 describes the dialog box fields.

XY View Dialog Box.

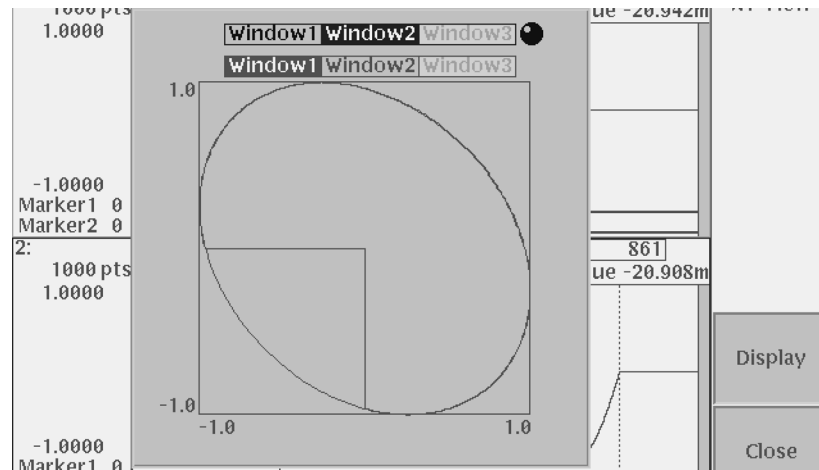

Figure 3-15: XY View dialog box

Table 3-19: XY View dialog box parameters

Parameters	Descriptions
X Axis	Specifies the waveform you want to assign to the X axis.
Y Axis	Specifies the waveform you want to assign to the Y axis.

Do the following steps to view two waveforms in an XY display:

1. Make sure that two or more windows are currently open.
2. Push **Tools** (bottom)→**XY View...** (pop-up)→**OK** (side).
The XY View dialog box appears.
3. Select the window waveform to use for the X axis.
4. Select the window waveform to use for the Y axis.
5. Push the **Display** side button to display the two specified waveforms in the XY view.
6. Push the **Close** side button to close the dialog box.

The Zoom/Pan Menu

You can use the Zoom function to expand or shrink the waveform display in an editor window. The Pan function shows a segment of waveform that lies outside the window due to the expansion.

When you push the **Zoom/Pan** bottom button, the side menu displays the operation menu. The displayed waveform can either expand or shrink, with the waveform data unchanged. If two or more waveforms are on display, this command zooms in on only the waveform of the current window.

Table 3-20: Zoom/Pan side menu buttons

Side buttons	Descriptions	
Direction	Specifies the direction of zoom or pan. The direction you specify here will apply to both zoom and pan operation.	
Zoom In	Expands the waveform with the center defined as follows:	
	Horizontal zoom	The active cursor is the center.
	Vertical zoom	The window center is the center.
Zoom Out	Shrinks the waveform with the center defined as follows:	
	Horizontal zoom	The active cursor is the center. (Left end, if the size has become smaller than the window width.)
	Vertical zoom	The window center is the center.
Zoom Fit	For horizontal	Horizontal fit takes place so that the whole waveform is contained in the window.
	For vertical	Vertical fit takes place so that the segment from -1.0 to 1.0 is contained in the window.
Pan	Assigns the general purpose knob to the waveform view movement.	

To do the Zoom/Pan, do the following steps:

1. If more than one window is open, select the source waveform as follows:
Push **Window** (bottom)→**Window1**, **Window2**, or **Window3** (side).
2. Push the **Zoom/Pan** bottom button to display the side menu.
3. Use the **Direction** side button to set the direction of zoom/pan.
4. Move the cursor to the center of zoom to perform horizontal zoom. When the Pan button is held down, the general purpose knob is already assigned to the pan function. To move the cursor using the general purpose knob, push the **TOGGLE** button to assign the cursor movement to the knob.
5. Push the **Zoom In** or **Zoom Out** side button to cause the waveform to expand or shrink.

If the desired portion of the waveform went outside the window as a result of zoom, move the waveform by using the Direction side button and the general purpose knob. For waveforms with extremely large amplitude or a large offset value, use the Pan function to bring it in the window.

6. Push the **Zoom Fit** side button to reset the expansion/shrinkage that is in the direction specified with Direction.
7. Push the **CLEAR MENU** or any other bottom button to terminate zoom/pan.

The Window Menu

The Window menu displays a side menu that lets you select which edit window is active. Simply push the side button of the window you want to make active.

NOTE. Push **File** (bottom)→**Open** (pop-up) to load a file into a second or third edit window.

The Settings Menu

There are a number of waveform parameters, including the number of data points in the waveform (data record length), the clock frequency, display mode, and horizontal units, that you can define. Although the instrument had default values for these parameters, you should set these to your own waveform requirements. You can use the Settings dialog box to set these parameters. To display the Settings dialog box, push the **Settings** bottom button. Figure 3-16 shows the Settings dialog box.

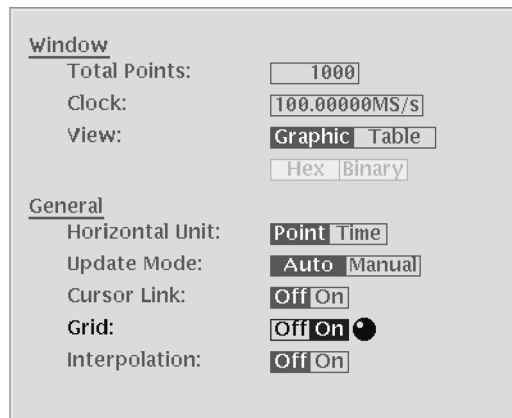

Figure 3-16: Settings dialog box

Window and General are two types of editor setup parameters. Window parameters only affects the active edit window. General parameters influence all windows currently opened and that will be opened, whether they are active or not. Table 3-21 describes the Window setup parameters, and Table 3-22 describes the general setup parameters.

Table 3-21: Setup window parameters

Parameters	Descriptions
Total Points	Specifies the data length of the waveform in the current window. The default is 1000 points. The range of data points is from 960 to 32400000/64800000 (opt.01) (16200000/32400000 (opt.01) :AWG710)and must be a multiple of 4. If you specify a value larger than the current data length, one or more zeros are added at the end of the data. If you specify a value less than the current length, all data after the end data point is deleted. The displayed value reflects data point changes resulting from any edit operations (such as cut or paste) that increase or decrease the number of data points in the record.
Clock	Specifies the clock frequency used to calculate the point-to-point time interval between each data point. The default setting is 100 MS/s. Note that this clock does not define the waveform output frequency.
View	Selects either the Graphic or Table waveform data display mode. The default setting is Graphic.
Table Type	Specifies to display tabular waveform data in binary or hexadecimal format. This selection is available only when the View parameter is set to Table. The Editor displays all data values in real numbers.

Table 3-22: Setup general parameters

Parameter	Description
Horizontal Unit	Specifies the horizontal axis data point unit (points or time) used to represent the position along the horizontal axis. The default setting is points.
Update Mode	<p>Specifies when output memory is updated. In Auto the output waveform is automatically updated in the waveform memory as you change the waveform in the editor. Changes are not saved to the original file, unless you manually save the changes.</p> <p>Note: Auto mode only works when the file you currently editing is also loaded in the waveform memory.</p> <p>Selecting Manual causes the instrument to update the output waveform only when the contents of the waveform file on the disk is changed by the save function of the editor.</p> <p>In Auto mode, you cannot edit waveform while the instrument is reloading. The longer the waveform, the longer you may have to wait to return to edit mode. Manual mode allows faster editing when you have a large number of points in the data file.</p>
Cursor Link	<p>Specifies whether to link cursor movement when two or three edit windows are open. Selecting ON causes the cursors in the inactive windows to be linked to their respective cursor in the active window. The default value is Off.</p> <p>If a linked cursor reaches either end of its data record before the active window cursor, the linked cursor remains at the data record end. This can result in changes to the relative cursor positions and edit areas between the editor windows.</p>
Grid	<p>Specifies whether to display a grid. Selecting On displays a grid in all open Graphical Waveform Editor windows. Selecting Off disables grid display. The default value is Off. The grid is not displayed in the Tabular Waveform Editor window or the Pattern Editor window.</p> <p>The instrument automatically sets the grid interval.</p>
Interpolation	<p>Specifies whether to enable waveform display interpolation when the density of points decreases due to zooming. Selecting On specifies that the instrument use the algorithm $aX^2 + bX + c$ to interpolate the waveform level between data points.</p> <p>Selecting Off displays the data point values as they are. The default value is Off.</p> <p>This function is provided to display a smooth waveform from data that contains relatively few data points in a cycle (such as in a disk test waveform). Note that this function may cause reduction in the linearity of some types of waveforms, such as a ramp waveform.</p>

The Pattern Editor

The Pattern Editor lets you create and edit data to output the analog signal. Graphic and tabular are the two display modes. The graphic mode displays the waveform graphically, while the tabular mode displays the tubular mode numerically in tabular form.

The instrument will interpret the data bit values and send the resulting signal to the CH 1 or $\overline{\text{CH1}}$ output.

About Waveform and Pattern Files

You can load both the waveform and pattern files to output a waveform to CH1 and $\overline{\text{CH1}}$. When you load a waveform file, the instrument converts the file to an 8-bit digital pattern and stores the pattern into the waveform memory. At the same time, the instrument stores the data in the pattern file into the waveform memory without any conversion.

The waveform file format is composed of 4-bytes for each data point and 1-byte for markers. The pattern file format is composed of 2-bytes including data and markers.

When you transfer the data, select pattern file to shorten the transfer time if you are not going to perform other operations on the data. The number of bytes in the pattern file is always less than that of the waveform file even though they are the same data length.

However, when you use waveform data to generate another waveform by mathematical operations, such as multiplying, dividing, or adding, you must keep the waveform data as a waveform file. The waveform file format exists for keeping the data precision in mathematical operations.

For more details about file format, refer to the *Data Transfer* section in the *AWG710&AWG710B Arbitrary Waveform Generator Programmer Manual*.

Starting the Pattern Editor

To start the Pattern Editor, push **EDIT** (front)→ **Edit** (bottom)→**New Pattern** (side). Figure 3-17 shows the Pattern Editor screen elements. All Pattern editor screen elements are the same as for the Waveform Editor (page 3-56) except for those listed in Table 3-23. All Pattern Editor bottom menu items are the same as for the Waveform editor (page 3-57) except for those listed in Table 3-24.

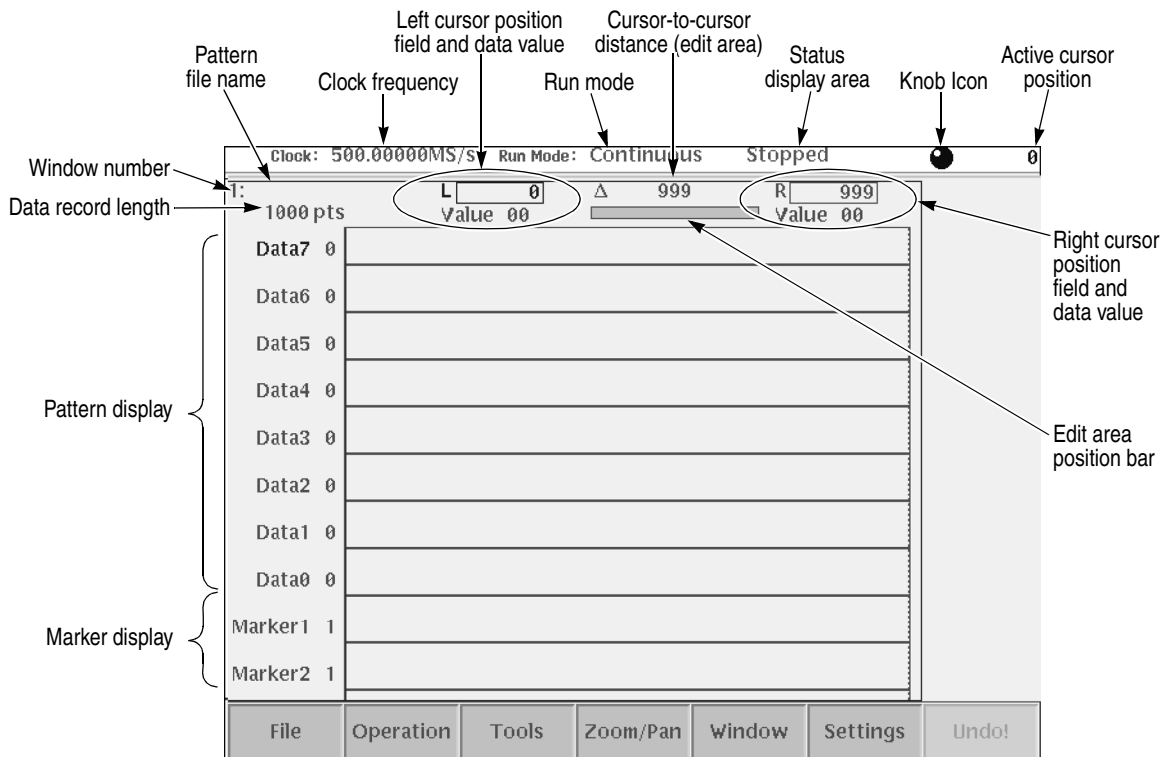

Figure 3-17: Pattern editor initial screen

Table 3-23: Pattern editor screen elements

Element	Description
Pattern display	The pattern display is a graphical representation of the pattern data values. There are a total of 8 data bits (Data0 through Data7) and two marker signals. Data values are 1 or 0.
Pattern file name	The pattern file name is a file name to which the waveform data is written. The instrument appends the .PAT file extension to all pattern files. If this is a new pattern, you are prompted to enter a file name before exiting the editor.

Table 3-24: Pattern editor bottom menu

Button	Description
Tools	Provides a command to convert pattern waveform data. This is the only Tools command available while in the Pattern Editor.

The File Menu

The File menu command descriptions are the same as those for the Graphical Waveform editor. Refer to *The File Menu* on page 3-58 for a description of the File menu commands.

The Operation Menu

The Operation menu command descriptions are the same as those for the Graphical Waveform editor except for Standard Waveform..., Vertical Shift..., Vertical Scale..., and Clip..., which are not available in the Pattern Editor. Refer to *The Operation Menu* section on page 3-59 for a description of the Operation menu commands.

The Tools Menu

The only Tools command available in the Pattern Editor is the Code Convert... command. This command creates a new pattern by using a user-specified table to convert the pattern of the specified line. The instrument opens a new window to display the results of the conversion.

Code Conversion Process

The outline for the code conversion procedures is:

- Use the data bits you specified with Target as the source data.
- Define the code conversion rules in a code conversion table.
- A new code conversion table must be created using the Edit... side menu command. An existing conversion table must be used with the commands in Open... side menu.
- Any new code conversion table created can be saved.
- When you push the **OK** side button, the pattern of code-converted source data is created in a separate window.

To open the code conversion table:

1. Push **Tools** (bottom)→**Code Convert...** (pop-up)→**OK** (side).
2. In the Code Convert dialog box, use the general purpose or the ◀ or ▶ button to specify the data scope to convert.

The side menu has commands related to the code conversion tables.

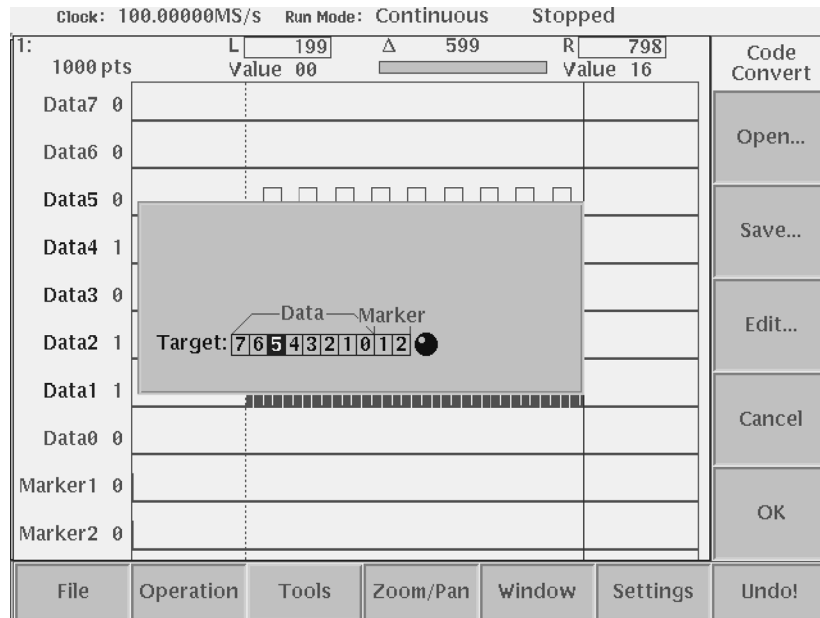

Figure 3-18: Code Convert dialog box and side menu

Table 3-25: Code conversion commands

Commands	Description
Open...	Reads an existing code conversion table.
Save...	Saves a code conversion table that was newly created or edited. It is saved in an ASCII file and the cells are separated by commas.
Edit...	Creates or edits a code conversion table.

Code Conversion Table

When you push the **Edit...** side button, the code conversion table appears as shown in Figure 3-19. Each code conversion table defines the template pattern that is used for pattern matching with the source code. Use the **Edit...** side button to create a new code conversion table. Alternatively, use the **Open...** side button to read an existing code conversion table.

Past Source	Current Source	Next Source	Past Output	Output Code

Figure 3-19: Code conversion table**Table 3-26: Code conversion parameters**

Parameters	Description
Past Source	Corresponds to the previous source data, which is to the left of the current noticed point. You can view up to eight points of past data.
Current Source	Shows the source data you are currently looking up. You may specify up to 16 points, starting in the noticed point.
Next Source	Specifies the source pattern that is further to the right of the portion read with Current Source. You can look at up to eight points of data.

Table 3-26: Code conversion parameters (cont.)

Parameters	Description
Past Output	The portion in which you view the output data that was output first. You can view up to eight points of the conversion result of the past output.
Output Code	Writes the resulting data of conversion that is output when all the above four conditions are satisfied. You may specify 16 points of data. If all conditions from Past Source to Past Output are satisfied in the conditions portion, Output Code will be output. Past Source, Current Source, Next Source, and Past Output are defined as conditions segments, and Output Code as the output segment.

Operations in the dialog box can be made as follows:

- A pattern must have been defined in at least one cell within a line conditions segment on one line.
- The number of points in a cell may be optional, unless it exceeds the maximum number of points. Any blank cell is ignored during pattern matching.
- Each cell must be a pattern of 0s, 1s, and/or don't care (minus) signs.
- The maximum definable number of lines is 1024 lines.

Code Conversion Mechanism

The following information explains the code conversion mechanism:

- Initial state: The left end of source data is defined as the noticed point. Past Source and Output Code data are regarded as all 0 data.
- The left and right patterns to the noticed point are compared with the individual lines of the conditions segment in the conversion table. The comparison is from the top to the bottom to find identical lines. If such lines are found, the Output Code data defined in the line is added to the output data.
- The noticed point shifts to the right. The amount of shift corresponds to the size of the Current Source data that was found to identical in the source data. The new noticed point is defined there.
- The above compare process for the individual lines is repeated for the new noticed point.
- An error is caused if there are no identical lines found during the compare process.

Refer to *Appendix F: Code Conversion* for code conversion examples.

Executing Conversion Follow the steps below to execute code conversion:

1. Push the **Save...** side button and name the file.
2. Push **OK** side button.

Code conversion is executed with the specified pattern as the source code. The result of code conversion is displayed in a new window.

The Zoom/Pan Menu

You can use the Zoom function to expand or shrink the waveform display in an editor window. The Pan function lets you scroll the pattern image to show waveform data that lies outside the edit display.

The Zoom/Pan menu commands are the same as those for the Graphical Waveform editor except that you cannot select vertical zoom/pan operations. You can only zoom or pan horizontally in the Pattern Editor. Refer to *The Zoom/Pan Menu* section on page 3-81 for a description of the vertical Zoom and Pan menu commands.

The Window Menu

The Window menu displays a side menu that lets you select which edit window is active. Push the side button of the window you want to make active.

The Settings Menu

The Settings menu commands define editor setup parameters, including waveform record length, clock frequency, display mode, cursor linking, grid on/off, and so on. The Settings menu commands are the same as those for the Graphical Waveform editor except for Grid and Interpolation. You can set grid and/or interpolation. However, the pattern editor does not use these parameters. These parameters are used only for the waveform editor when you are editing two or more windows. Refer to *The Settings Menu* section on page 3-82 for a description of the Settings menu commands.

The Undo! Command

The Undo! command reverses the last edit operation. This is only a one-level undo function.

Selecting Data Bits to Edit

Like the waveform editor, the pattern editor executes operation menu commands on the data between the two cursors. You must select which of the 8 data bit signals to edit. Selected bits (data and marker) are indicated by highlighting the data bit and/or marker names at the left of the pattern display area. The selected bits are referred to as the edit scope. For example, Figure 3-20 shows the edit scope (selected data bits) as Data5 through Data1. Note that you can only select contiguous sets of data bits.

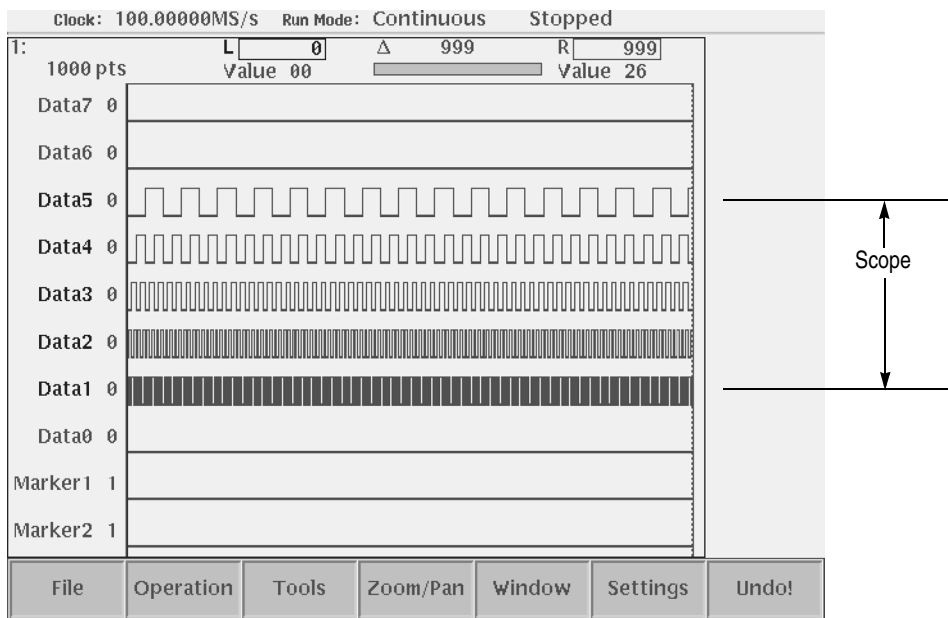

Figure 3-20: Operating data bits (scope)

To specify the edit scope, do the following steps:

1. Push **Operation** (bottom)→**Select Lines** (pop-up)→**OK** (side).
The side menu items From and To appear.
2. Push the **From** side button and specify the start bit of the scope using the general purpose knob or numeric buttons.
The option may be Data0 to Data7, Marker1, and Marker2.
3. Push the **To** side button and specify the end bit of the scope using the general purpose knob or numeric buttons.
The option may be Data0 to Data7, Marker1, and Marker2.

Do the following to copy data from one bit to another. The following example copies Data7 data, consisting of 1000 points, to Data0.

1. Place the left cursor at data point 0, and the right cursor at data point 999. Make the left cursor active with the **TOGGLE** button.
2. Push **Operation** (bottom)→**Select Lines** (pop-up)→**OK** (side).
3. Push the **From** side button to set to Data7.
4. Push the **To** side button to set to Data7.
5. Specify the edit scope position as Data9 using the ▲ or ▼ button. (Data9 is highlighted.)
6. Push **Operation** (bottom)→**Copy** (pop-up)→**OK** (side).
7. Specify the edit scope position as Data0 using the ▲ or ▼ button. (Data0 is highlighted.)
8. Push **Operation** (bottom)→**Paste (Replace)** (pop-up)→**OK** (side).

Defining Edit Area

Figure 3-21 shows an example of the waveform pattern created in the area defined by area cursor. All edit operations act on either the area between the cursors or the area to the right of the active cursor. When you edit a pattern, you must first specify the area or the position to be edited.

The area to edit is specified as the area between the left and right vertical cursors. You can select the active cursor by pushing the **TOGGLE** button, and move a cursor by using the general purpose knob or numeric keys.

- Push the **TOGGLE** button on the front panel to switch the active cursor between the left and right cursor. You cannot activate both the left and right cursors at the same time. The activated cursor is represented with the real vertical line and the nonactive cursor with the dashed vertical line.
- Move the active cursor to the position to be edited.

Depending on the type of operation, only the active cursor position may be important. In this case, you must activate either the left or right cursor and move to the position to perform the action.

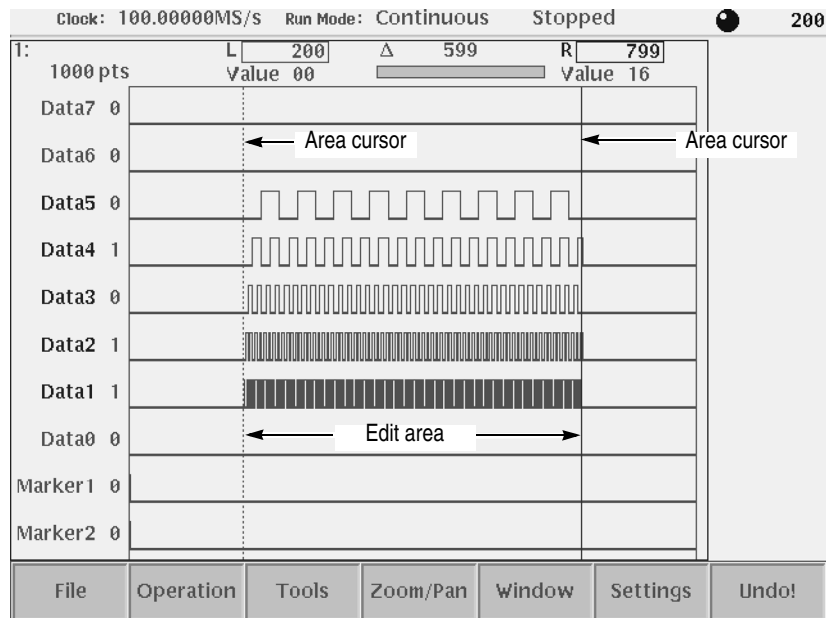

Figure 3-21: Area cursors

Creating a Pattern

The New Pattern command opens a pattern edit window with the following default values:

Data length: 1000 points
 Bit value level: 0
 Clock frequency: 100 MS/s
 Edit scope: Data7 through Data0

The Pattern Editor does not change the data length when executing **Cut** operations. To create 1000–point or shorter data, change the data length in the Total Points item of the **Settings** menu.

For creating pattern, you can use the following methods alone or in combination:

- Select from standard patterns
- Import from external file
- Newly created and/or edit pattern
- Generate random pattern

Creating Standard Patterns

The counter dialog box lets you specify the type of pattern and the range (scope) of data bits to apply to the pattern. See Figure 3-22. The instrument lets you create one of four standard counter patterns as listed in Table 3-27, and inserts the pattern in the edit area between the cursors.

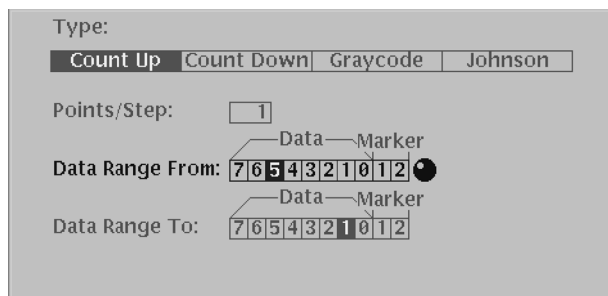

Figure 3-22: Counter dialog box

Table 3-27: Patterns to be selected in Counter dialog box

Standard patterns	Descriptions
Count Up	Creates a binary incrementing counter pattern
Count Down	Creates a binary decrementing counter pattern
Graycode	Creates a gray code counter pattern
Johnson	Creates a Johnson counter pattern

Do the following steps to create a counter pattern:

1. Specify the scope and area in which you want to create the pattern.
2. Push **Operation** (bottom)→**Counter...** (pop-up). The Counter dialog box as shown in Figure 3-22 is displayed.
3. Select a type (standard pattern) from the dialog box.
4. Specify the number of points in Points/Step in which you want to represent one step of the standard pattern.

You may specify a value from 1 to 100 by using the general purpose knob or numeric buttons.

- 5. Specify bit width in the Data Range From and Data Range To. These two parameters specify the counter bit width and the position in the data. The markers are also available.
- 6. Push the **OK** side button.

Inserting Data From Files

You can import pattern data from a file on the floppy drive, hard disk, or the network, to any location in the current pattern edit window. The data is inserted at the active cursor position. Importing data results in an increase in the record length (number of points) of the pattern.

Do the following steps to import pattern data from a file:

- 1. Move the cursor to the position to which you want to move the data.
- 2. Push **File** (bottom)→**Insert from File...** (pop-up)→**ENTER** (front).
- 3. Select the file from the Select File dialog box.
- 4. Push the **OK** side button.

Set Pattern...

This command generates a binary pattern (0 and 1 values) for the cursor-to-cursor waveform data or markers. You have two options of generating this pattern: you can enter the new data using the numeric buttons or keyboard, or you can import the pattern from the current edit area between the cursors. You can specify the data or markers with **Target**, which is displayed in the Set Pattern dialog box, regardless of the scope selection.

Set Pattern dialog box. Figure 3-23 shows the Set Pattern dialog box that lets you set a pattern.

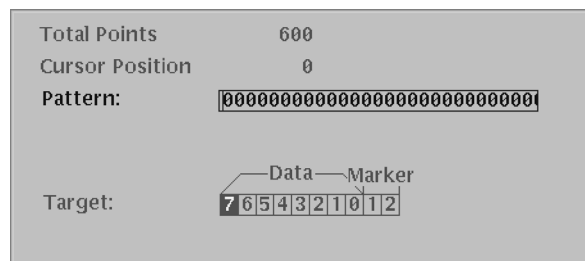

Figure 3-23: Set Pattern dialog box

Table 3-28: Set Pattern dialog box parameters

Parameters	Descriptions
Total Points	Specifies that the number of points of a pattern defined in the [Pattern] field. This value cannot be modified using numeric buttons.
Cursor Position	Specifies that the cursor position in the [Pattern] field is displayed. This value cannot be modified using numeric buttons.
Use Code Table	Specifies whether to use the code translation table.
Pattern	Specifies the pattern field value. Enter the value using the '0' or '1' numeric button. Push the Import Pattern side button to set the cursor-to-cursor data corresponding to the section specified in Target.
Target	Specifies the location in which the generated data is created. If you specify Data, the '01' pattern will be generated in the pattern section. The pattern imported with the Import Pattern side menu is from the Target specified in this field.

Operations in the dialog box are as follows:

- Use the ▲ or ▼ button to move the selection to move up or down.
- Use the general purpose knob or the ◀ or ▶ button to move the selection cursor left or right.
- The pattern between the cursor lines you specified in Target is imported by pushing the **Import Pattern** side button.
- Push the **Clear Pattern** side button to cause the pattern field value to clear to NULL.
- Push the **OK** side button to cause the pattern in the Pattern field to be generated between the Target cursors. If this pattern is shorter than the cursor-to-cursor interval, continue pushing the **OK** side button until it is filled. If the pattern is longer than the interval, use part of the pattern to fill this interval.

Do the following steps to set a pattern:

1. Move the cursors to specify the area in which you want to generate a pattern.
2. Push **Operation** (bottom)→**Set Pattern...** (pop-up)→**OK** (side).
The Set Pattern dialog box appears.
3. Specify the location where the pattern is created.
You can do this from Data, Marker1, or Marker2 in the Target.
4. Push the **Import Pattern** side button to import the cursor-to-cursor data.

If necessary, you can change the pattern value by moving the cursor with the ◀ or ▶ button and then using numeric keys and the ← key.

5. Push the **OK** side button to generate the Pattern field pattern between the cursors in the area specified in Target.

A pattern is generated in the cursor-to-cursor area you specified in **Target**.

Numeric Input...

The Numeric Input... command enables you to set the pattern data located in the current active cursor position by using the numeric buttons. The marker values can also be set.

1. Move the cursor to the point where you want to set a value.
2. Push **Operation** (bottom)→**Numeric Input...** (pop-up)→**OK** (side).
3. The current values are displayed in the Data, Marker1, and Marker2 side menus. In this condition, you can change the position setting by moving the cursor.
4. Push the **Data** side button, then set the pattern data value using the general purpose knob or numeric keys.
5. Push the **Marker1** or **Marker2** to toggle between the marker values.

NOTE. *The value modified through the side menu are immediately reflected in the data. Push **Undo!** to cause the value to return to the previous value.*

Quick Editing

Quick edit allows you to modify and output the currently edited waveform (with the waveform editor) in real time by using the knobs on the front-panel. The Quick Edit enables you to scale or shift the cursor-to-cursor data on the Waveform editor screen along the vertical and/or horizontal axis. Use the vertical scale, vertical offset, horizontal scale, and horizontal offset front-panel knobs.

If Update Mode is set to Auto with the waveform editor, waveform modifications using the knobs are automatically updated to the waveform file and to the output waveform.

NOTE. *You can enter into the quick edit mode only from the waveform editor. You cannot enter into the quick edit mode when the AWG710B is set to the Synchronous Operation mode.*

Screen Display

Open a target waveform with the waveform editor, and then push the **QUICK EDIT** button on the front-panel. The screen is the same as that of the waveform editor in graphic mode except for the bottom and side buttons. A bottom button is not available, and only three side buttons can be used for adjusting the editing parameters. See Figure 3-24 for an example of the quick edit screen.

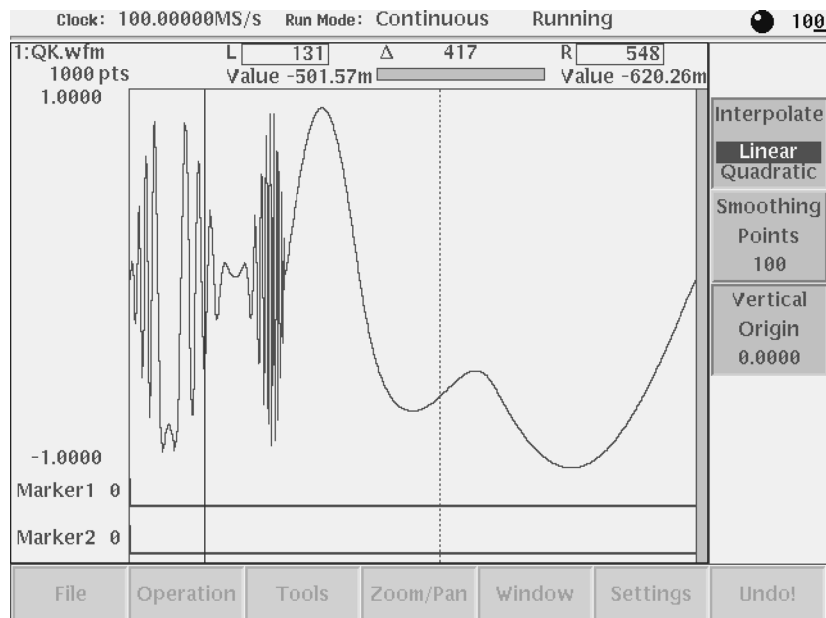

Figure 3-24: A waveform example under quick editing

Quick Edit Mode

Using the Quick Edit mode enables the following:

- Operating four knobs of VERTICAL SCALE, VERTICAL OFFSET, HORIZONTAL SCALE, and HORIZONTAL OFFSET.
- Setting parameters in the Quick Edit screen
- Moving the cursors using the general purpose knob or numeric keys
- Operations not requiring menu changes (pressing a button such as RUN, OUTPUT, or HARDCOPY)
- Updating the contents of the edit buffer

Quick Edit Mechanism

When you enter into the quick edit mode, the instrument copies the data that is in the edit buffer and places it into the undo buffer. All the changes you make immediately reflect to the data in the edit buffer (and also to the data in the waveform memory if that data is being loaded to output).

When you cancel the changes and quit the quick editor, the instrument copies the data in the undo buffer back to the edit buffer (and also to the waveform memory if the data is being loaded), and then terminate the quick editor.

About Smoothing

Quick Edit performs expand, shrink, or shift the cursor-to-cursor data. Consequently, if nothing is processed, a gap may be produced between the changed and unchanged portions. To link the entire data smoothly, smoothing is performed.

Cursor-to-cursor points move in response to turning the general purpose knob. Also for the unchanged portions, the smoothing moves the positions so that the entire data is linked smoothly. This occurs throughout the range specified with the Smoothing Points side menu. The amount of shift is calculated internally to enable a smooth link and to minimize the effect on the unchanged portions. The calculation uses a cubic polynomial for the horizontal amount and sine for the vertical amount.

The value of the points mentioned above are usually nonintegers. That is, the resulting horizontal coordinates of the points are not integers. The values at the coordinates (integers) on the horizontal axis of the waveform data are sequentially obtained using the interpolation you specified with the Interpolate side menu.

Quick Controls

To enable the Quick Edit mode, press the **QUICK EDIT** front-panel button, as shown in Figure 3-25.

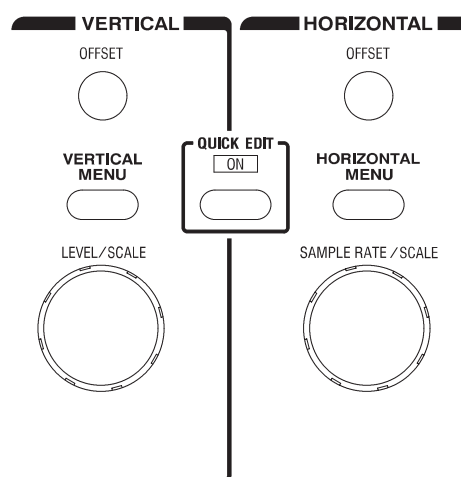

Figure 3-25: Controls for quick editing

VERTICAL SCALE Knob The cursor-to-cursor data is scaled vertically with the Vertical Origin side menu as the center. You may set a three-digit value (0.1 to 10.0) for the scaling factor. Smoothing should be done for the area you specified with the value set in the Smoothing Points side menu, with the appropriate cursor position as the center.

VERTICAL OFFSET Knob The cursor-to-cursor data is shifted vertically. The amount of shift can be set in 0.001 increments in the -0.5 to 0.5 range. Smoothing should be done for the area you specified with the Smoothing Points side menu, with the appropriate cursor position as the center.

HORIZONTAL SCALE Knob The cursor-to-cursor data is scaled horizontally with the midpoint of the data as the center. You may set a three-digit value (0.1 to 10.0) for the scaling factor. Smoothing should be done for the area you specified with the Smoothing Points side menu, with the end point of the scaled data as the center.

HORIZONTAL OFFSET Knob The cursor-to-cursor data is shifted horizontally. The amount of shift can be set with a five-digit value from -1000.0 to 1000.0 (0.001 point resolution). Smoothing should be done for the area you specified with the Smoothing Points side menu, with the end point of the scaled data as the center.

Starting Quick Edit

Quick Edit works for the cursor-to-cursor waveform data you placed in the edit mode in the Waveform editor.

Follow the steps below to start Quick Edit.

1. Start the Waveform editor to display the target waveform.
2. Specify the modification area using the cursors.
3. Press the **QUICK EDIT** button on the front-panel.

The QUICK EDIT LED stays on while you are in the Quick Edit mode.

You must load the target waveform into the waveform memory to observe changes while outputting the waveform.

Follow the steps below to load and output the target waveform:

1. Select **SETUP** (front-panel)→**Waveform/Sequence** (bottom)→**Load** (side).
2. Set the output parameters on the side menu screen to output the waveform.
3. **Waveform/Sequence** (bottom)→**Edit...** (side).

Place the loaded waveform in the edit mode.

4. Specify the modification area using the cursors.
5. Press the **Quick EDIT** button on the front-panel to execute Quick Edit.

NOTE. When a waveform is loaded in the waveform memory, the changes made in the Quick editor cannot reflect to the output. To reflect the changes to the output, be sure to load the target waveform in the **SETUP** menu, enter into the editor, and then enter into the Quick Editor.

Exiting Quick Edit

When exiting Quick Edit, you can select whether or not to save the waveform changes.

1. Press the **QUICK EDIT** button on the front panel.
2. Before Quick edit is exited, you are asked if you want to fix the current changes.
3. Select the **Yes**, **No**, or **Cancel** side menu.

Setting Parameters

Interpolating Method

When changes are made to the waveform by turning a knob, the values of the shifted points are calculated by interpolation. You can select either Linear or Quadratic for the interpolating method.

Press the **Interpolation** side button to toggle between Linear or Quadratic.

Range of Smoothing

When changes are made to the waveform by turning a knob, the shifted points and the points in the nonshifted area are linked smoothly. This is called smoothing. This parameter specifies the extent (of the nonshifted points) to which smoothing applies. The value may be 0 to 1000.

1. Press the **Smoothing** side button.
2. Use the general purpose knob or numeric keys for value.

Position of Center of Vertical Extent

This specifies the center used for vertical scaling. The value may be -1.0 to 1.0.

1. Press the **Vertical Origin** side button.
2. Use the general purpose knob or numeric keys to change the value.

Moving the Cursor

During execution of Quick Edit, you can change the target area for editing, by moving the cursors. When you use one of the four VERTICAL/HORIZONTAL knobs; the general purpose knob and the numeric keys remain assigned to change the value. To move a cursor, press the TOGGLE button on the front-panel before operating the general purpose knob or numeric keys.

Follow the steps below to move the cursor:

1. Press the **TOGGLE** button on the front-panel to assign the general purpose knob to cursor movement.
2. Set the cursor position using the general purpose knob or numeric keys.

Renewing Edit Buffer

During execution of Quick Edit, you can combine the four VERTICAL and HORIZONTAL knobs and the general purpose knob for the operation purpose. Each time you operate any of the knobs, the following internal calculation is made to renew the waveform data:

- The cursor-to-cursor data is defined as the object of calculation with respect to the waveform that was obtained when you start Quick Edit.
- Using the current Vertical Scale, Vertical Offset, Horizontal Scale, and Horizontal Offset values, the calculation is made in this order with respect to the cursor-to-cursor data.
- Smoothing is executed.

About Undo

The undo buffer is used for waveform backup, so the Quick Editor does not support the Undo! function. Before exiting Undo!, you are asking whether to reflect the changes to the waveform. To cancel the changes, select **No**.

The Table Editor

Editing in the graphic display lets you see the shape of the waveform you are editing. However, changing data values in the graphical edit mode is a difficult task. The Table Editor lets you quickly enter or edit data values by using a table display format.

Opening The Table Editor

By default, the Waveform and Pattern editors open in the graphic display mode. (The assumption is made that you have already opened a waveform or pattern file.)

Do the following steps to switch to the Table Editor:

1. Push the **Settings** bottom button to display the Settings dialog box.
2. Select **Table** in the View field.
3. Push the **OK** side button.

The instrument opens the Table Editor, as shown in Figure 3-26.

Follow the procedure above to return to the graphic display mode. Select **Graphic**, instead of Table, in step 2.

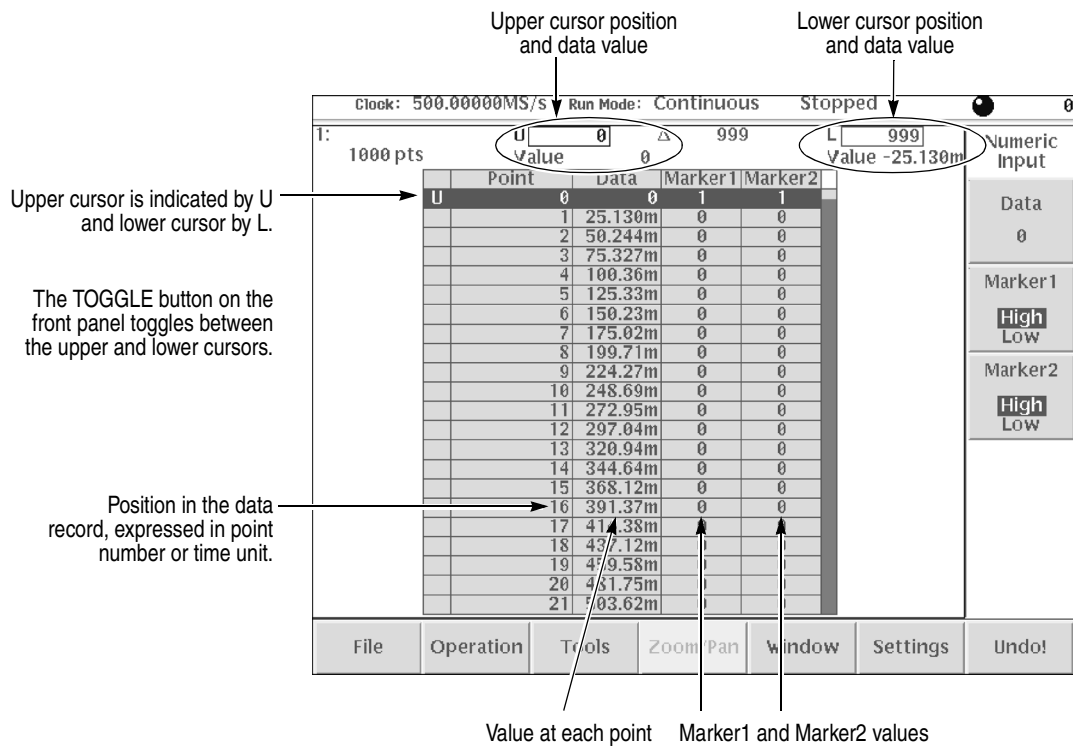

Figure 3-26: Table Editor window

Editing The Table Data

The Numeric Input... command in the Operation bottom menu lets you edit waveform and marker data in the Table Editor. Do the following steps to edit the waveform or the marker data in the table:

1. Use the general purpose knob or cursor fields to move the active cursor to the data point that you want to edit.
The active data point is the highlighted row in the table.
2. Push **Operation** (bottom)→**Numeric Input...** (pop-up).
3. To edit waveform data, push the **Data** side button and change or enter the data value using the general purpose knob, keyboard, or keypad buttons.
4. To edit the marker data, push the **Marker 1** or **Marker 2** side button to toggle between High and Low.

The data in table display mode is the same data that is displayed in the graphic editors. You can use all applicable bottom menu commands, except for the Zoom/Pan commands, to manipulate data in the Table Editor mode.

NOTE. Remember that you need to define the edit area (data points located between the cursors) before executing the Operation commands.

To look at the waveform area outside the current display area, scroll the display using the general purpose knob or the ▲ and ▼ buttons. If the data to view is more than 50 data points away from the current cursor location, it is faster to use the numeric keypad to enter the new cursor value in the Cursor Position field.

Pushing the **TOGGLE** front-panel button switches the table contents to show the data values at the other cursor. When toggling between the cursors, the Table Editor displays the Upper cursor at the top of the table and the Lower cursor at the bottom of the table.

The Equation Editor

The Equation editor is an ASCII text editor that includes menus and commands for writing waveform equation files using the Waveform Programming Language (WPL). You can use WPL to generate a waveform from a mathematical function, perform calculations between two or more waveform files, and use loop and conditional branch commands to define waveform values.

The WPL duplicates almost all of the AWG710&AWG710B Arbitrary Waveform Generator Waveform and Pattern editor functions. However, you cannot perform sequential data processing on a point-by-point basis. Instead, the Equation editor has functions for performing calculations between two or more waveform files that affect all the points in a waveform.

To output an equation waveform you must compile the equation file into a waveform file.

NOTE. *It is highly recommended that you install a PC-style keyboard if you intend to use the Equation editor. It is much easier to enter and edit text from a keyboard than to use the front-panel controls to edit a file.*

In this manual, all equation file names use the extension .equ to differentiate them from nonequation-content text files.

You can use the Equation editor to create and load text-only files, such as readme or other text files. However, the focus of this section is to describe how to use the Equation editor to create waveform equations.

Starting the Equation Editor

To start the Equation editor, push **EDIT** (front)→**Edit** (bottom)→**New Equation** (side). You can also automatically start the Equation editor by loading an equation file from the EDIT menu file list. Figure 3-27 shows the Equation editor screen. Table 3-29 describes the editor screen elements that are specific to the Equation editor. Table 3-30 describes the bottom menu functions. The sections that follow Table 3-30 describe the menu operations in detail.

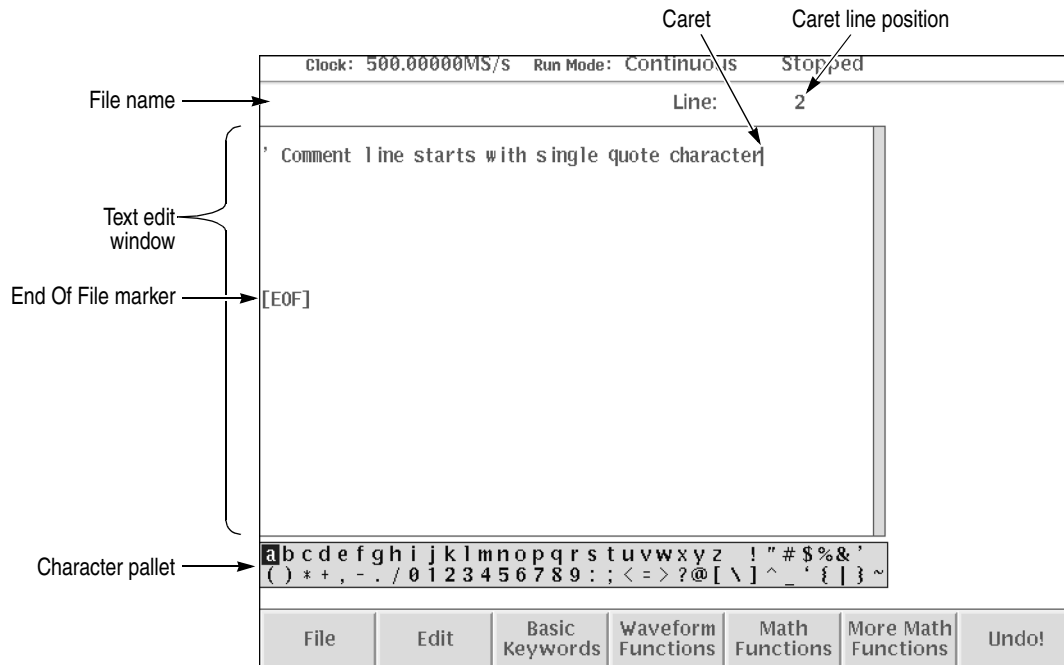

Figure 3-27: Equation editor window

Table 3-29: Equation editor screen elements

Element	Description
File name	The file name to which the equation or text is written, or the name of the file being edited. The instrument appends the default <i>.txt</i> file extension to all Equation editor files. If this is a new file, you are prompted to enter a file name before exiting the editor. It is suggested that you use the <i>.equ</i> file extension to identify equation files.
Caret line position	The line number in the file where the caret is located. The file starts at line 1.
End Of File marker	Indicates the end of the file. All equations or text must be entered before this marker.





Table 3-29: Equation editor screen elements

Element	Description
Character pallet	Used with the general purpose control knob to enter alphanumeric characters into the edit window. To enter a character at the caret position, highlight a character and push the ENTER button.
Text edit window	Area where you enter text and/or equation information. The maximum length of a line is 256 characters, including spaces. You can concatenate lines by entering a colon character (:) at the end of a line. The maximum number of characters you can concatenate is 1000.
Caret	A vertical bar that indicates the position in the file where edit operations take place. Use the front-panel or keyboard arrow keys to move the caret.

Table 3-30: Equation editor bottom menu

Button	Description
File	Provides side-menu commands for closing the editor, saving text to the current file or a new file, and compiling an equation file into a waveform file. Refer to page 2-17 for information on relevant file management tasks.
Edit	Provides side-menu commands for text edit functions to cut, copy, paste, select, and insert text.
Basic Keywords	Provides a pop-up menu of WPL basic keywords. The keywords are described in the <i>Waveform Programming Language</i> section beginning on page 3-185.
Waveform Functions	Provides a pop-up menu of WPL waveform operation keywords. The keywords are described in the <i>Waveform Programming Language</i> section.
Math Functions	Provides a pop-up menu of WPL math operation keywords. The keywords are described in the <i>Waveform Programming Language</i> section.
More Math Functions	Provides a pop-up menu of more WPL math operation keywords. The keywords are described in the <i>Waveform Programming Language</i> section.
Undo!	Reverses a character or string cut or paste operation to the previous state. This is a one-level undo function.

Using the Equation Editor

The text display area and character palette are shown on the display. Input characters or strings (such as keywords) using bottom buttons. Use the general purpose knob and the , , , and  buttons to input characters.

Front-Panel Edit Controls

Table 3-31 describes the front-panel buttons, keys and knob to use for entering and editing text.

NOTE. *It is highly recommended that you install a standard PC-style keyboard if you intend to use the Equation editor. It is much easier to enter and edit text from a keyboard than to use the instrument front-panel controls.*

Table 3-31: Front-panel Equation editor controls

Control	Description
◀ and ▶ button	Moves the caret horizontally in the edit area. Hold down an arrow key to continue moving the caret in the specified direction.
▲ and ▼ button	Moves the caret vertically in the edit area. Hold down an arrow key to continue moving the caret in the specified direction.
General purpose knob	Selects a character in the Character Palette.
ENTER button	Inserts the highlighted character in the Character Palette at the caret location.
← Key	Deletes the character that is to the left of the caret in the edit area.
SHIFT Button	Toggles between the uppercase and lowercase character modes in the Character Palette.
↵ Key	Inserts a line feed character at the caret position and moves all following text down a line.

Do the following steps to insert a character:

1. Use the general purpose knob to select the character from the character palette.
2. Press the **ENTER** key.
The character is inserted at the current caret position.
3. Use the arrow keys to move the caret in the edit area.

Selecting Text

You must select text before doing copy or cut operations. Do the following steps to select text:

1. Move the caret to the start of your text to select.
2. Push **Edit** (bottom)→**Selection** (side) menu.
3. Push the ◀ or ▶ buttons to select text. See Figure 3-28. The selected text is highlighted. You can now cut or copy the selected text to the paste buffer.

NOTE. You can also use the **TOGGLE** button to toggle the text selection mode to on and off.

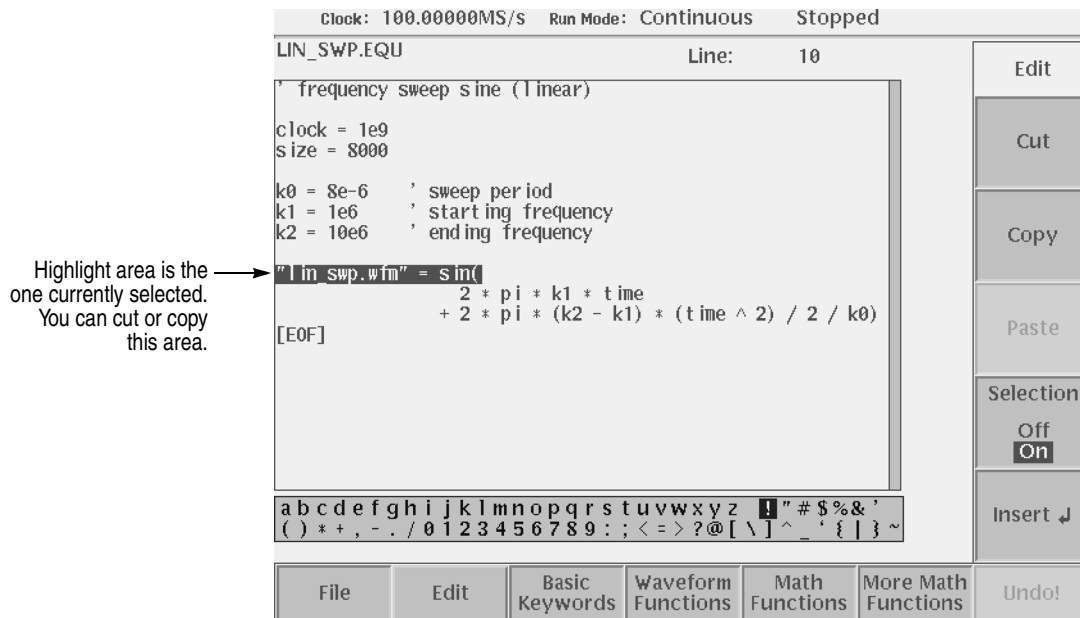

Figure 3-28: Text selection (example)

Cutting, Copying, and Pasting Text

The Paste command inserts the paste buffer text starting at the caret position. You must have copied or cut text prior to using the Paste command.

Do the following steps to cut or copy text from the edit area:

1. Select the text to cut or copy. Refer to *Selecting Text* on page 3-112.
2. Push the **Cut** side button to delete the selected text from the edit area and place it in the paste buffer from the selection range.
3. Push the **Copy** side button to copy the selected text from the edit area and place it in the paste buffer.

The text is unselected after completing the copy operation.

Do the following steps to paste text into the edit area:

1. Move the caret to where you want to insert the paste buffer text.
2. Push the **Paste** side button. The string in the paste buffer is inserted at the caret position.

Using an External Keyboard

You can connect a 101- or 106-keyboard to the rear panel. You can use the keyboard to enter the same characters shown in the Character Palette. Use the Shift key to enter uppercase characters. Table 3-32 describes the editor operations available from the keyboard.

Table 3-32: Control keys from the external keyboard

Keyboard key	Description
Character and numeric keys	Characters found in the character palette can be input from the corresponding keys on the keyboard.
Arrow keys	Moves the caret horizontally or vertically.
Back Space	Deletes the character that is to the left of the caret.
Delete	Deletes the character that is to the right of the caret.
Return	Inserts an End Of Line character at the caret position.
Ctrl-C	Copies selected text to the paste buffer.
Ctrl-X	Cuts selected text to the paste buffer.
Ctrl-V	Pastes the contents of the paste buffer at the caret location.
Ctrl-Z	Reverses the last character, cut, or paste operation to the previous state.
Ctrl-S	Toggles the selection on and off.

Entering Keywords and Functions

The Equation editor has built-in keywords and functions to make creating equations an easier task. These commands insert correctly-formatted keywords or functions into the text file at the current caret position. Inserted keywords are treated as ordinary text if you need to edit them. The keywords are described in the *Waveform Programming Language* section starting on page 3-185.

Do the following steps to insert a keyword or function:

1. Move the caret to the position you want to insert the keyword or function.
2. Push the **Basic Keywords**, **Waveform Functions**, **Math Functions**, or **More Math Functions** bottom button. A pop-up menu appears.
3. Select the keyword to insert from the pop-up menu.
4. Press the **OK** side button. The keyword is inserted at the caret position.

Compiling Equations

The instrument cannot directly output an equation waveform. You must compile the equation into a standard waveform file. You then load and output this waveform file the same as any other waveform file. You can compile an equation file from either the Equation editor or the main EDIT menu.

The syntax checker runs after you initiate the compile command. The error line number is displayed if a syntax error is found.

Compiling from the Equation Editor

Do the following steps to compile an equation from the Equation editor:

1. Push **File** (bottom)→**Compile** (side).

The instrument checks the equations for syntax errors. If the equation file contains syntax errors, the instrument displays the line number it thinks contains the syntax error. Push the **OK** side button to return to the editor and correct the equation(s).

If the equations contain no syntax errors, the instrument compiles the equations and saves them to a standard waveform file. The instrument then displays the names of the new waveform file. By default, the instrument uses the equation file name with a *.wfm* suffix.

2. Select the compiled waveform in the list, and push the **View** side button.

The instrument displays the waveform in the waveform view window.

3. Push the **Close** side button to return to the editor screen.

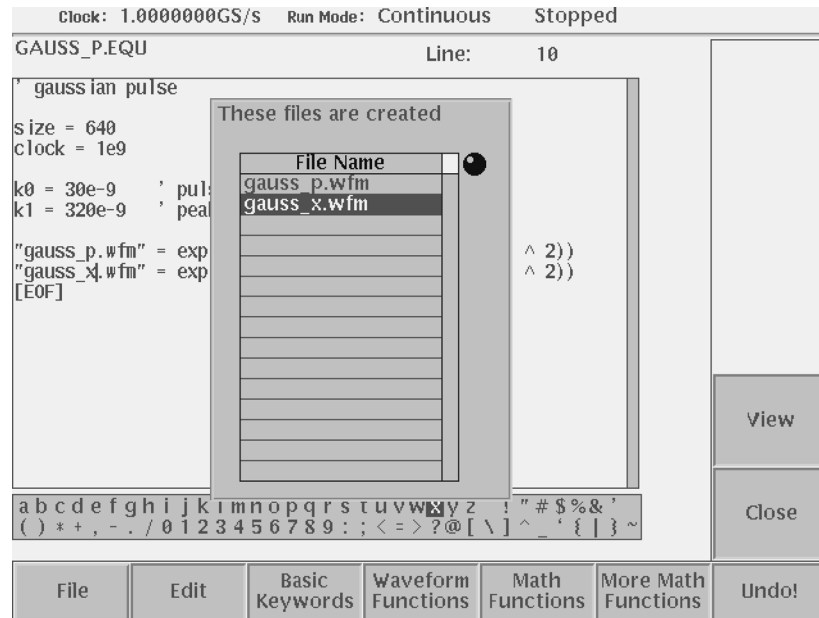

Figure 3-29: File list listing two waveforms created

Compiling from the EDIT Menu

Do the following steps to compile an equation from the main EDIT screen:

1. Push the **EDIT** button once or twice to display the EDIT file listing screen.
2. Select an equation file from the file list.
3. Push **Tools** (bottom)→**Compile Equation** (side).

The instrument checks the equations for syntax errors. If the equation file contains syntax errors, the instrument displays the line number it thinks contains the syntax error. Push the **OK** side button to clear the error message. You must then open the equation file in the Equation editor to fix the error.

If the equations contain no syntax errors, the instrument compiles the equations and saves them to a standard waveform file. By default, the instrument uses the equation file name with a *.wfm* suffix.

4. Select the compiled waveform in the list, and push the **Edit** side button.

The instrument displays the waveform in the Waveform editor window.

The Sequence Editor

The Sequence editor is used to create a sequence file. A sequence file is simply a list of waveform file names that the instrument will output. Additional parameters like repeat count, event triggering, and conditional jumps allow you to generate very large and complex output waveforms. You can also specify another sequence file as an output file. This section describes the features of the Sequence editor. *Tutorial 6: Creating and Running Waveform Sequences* on page 2-70 provides detailed instructions for creating sequence files.

Starting the Sequence Editor

To start the Sequence editor, push **EDIT** (front)→**Edit** (bottom)→**New Sequence** (side). You can also automatically start the Sequence editor by loading a *.seq* file from the EDIT menu file list. Figure 3-30 shows the Sequence editor screen with an example sequence list. Table 3-33 describes each column of the sequence table, with more information and procedures on page 3-122. Table 3-34 describes the bottom menu functions. The sections that follow Table 3-34 describe the menu operations in detail.

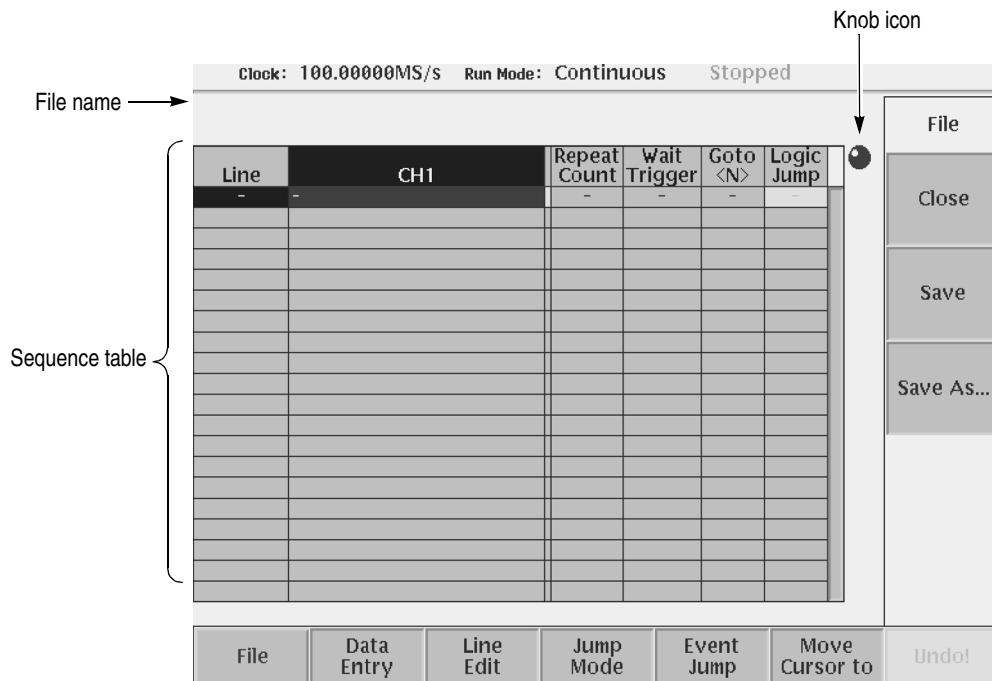

Figure 3-30: Sequence editor initial screen

Table 3-33: Sequence table columns

Column	Description
Sequence file name	Remains blank if you have not saved the sequence once after opening a new file.
Line	Sequence line number. It is assigned automatically here as a result of the addition or deletion of a line.
CH1	<p>Specifies the waveform or sequence file to output on CH 1 for that line of the sequence table.</p> <p>A sequence file may be specified for an output file. You can only nest sequence files one level.</p> <p>The waveform file name cannot contain a drive or directory name. The sequence file and all waveform files called must be accessible at the same directory level. If the waveform file name fields for CH1 is blank on a sequence line, or the instrument cannot locate a specified file, the instrument displays an error message and aborts loading the sequence file.</p> <p>The data length of each waveform file used for the sequence process must be a multiple of 4 from 960 points to 32.4 M/64.8 M (option 01) (16.2 M/ 32.4 M (option 01) :AWG710) points. For sequence output, the total of data length of the waveforms must not exceed 32.4 M/64.8 M (option 01) (16.2 M / 32.4 M (option 01) :AWG710) points.</p>
Repeat Count	Specifies the number of repeats. You may specify any integer from 1 to 65536, or select the keyword Infinity. The Infinity setting is neglected in a nested sequence file (subsequence).
Wait Trigger	Causes the instrument to wait for a trigger event before outputting the waveform(s) on the specified sequence table line. Valid values are On and Off (blank). Wait Trigger functionality is only valid when the Run Mode is set to Enhanced. This setting is neglected in the subsequence.
Goto <N>	<p>Specifies the number (n: 1 to 8000) and jumps to the specified sequence table after outputting the current signal. Goto <N> functionality is only valid when the Run Mode is set to Enhanced. This setting is neglected in the subsequence.</p> <p>Note that, for the last line of the sequence table, this setting is always 1 regardless of the setting.</p>
Logic Jump	Specifies the sequence table to jump to a specified line depending on signal values on the EVENT IN connector. You may specify Next (go to the next line) or Off (blank) as well as specify the sequence line number for the destination. Selecting Off means that the line that is currently being edited is set as a jump address. For example, when an event occurs during the output of the waveform set in the line 5 with jump off, the waveform in the line 5 is output again from the top. This field remains gray if the Jump Mode is set to Table or Software. This setting is neglected in the subsequence or when the jump mode is set to Software.

NOTE. Infinity setting in Repeat Count and all settings in Wait Trigger, Goto <N> and Logic Jump are neglected in the subsequence.

NOTE. The AWG710&AWG710B Arbitrary Waveform Generator saves memory by saving waveforms that are output when using the sequence editor, if the waveforms that are output from the instrument are identical. However, the subsequence set to multiple repeat count is expanded into the sequence memory, so you need to be careful about the waveform data length. Also refer to Limitations on Using Sequences on page 3-128.

If you use multiple waveforms, the instrument may not output the waveform even though the number of points are within the 32.4 M or 64.8 M (option 01) (16.2 M or 32.4 M (option 01) : AWG710). This is because the waveform memory is comprised of internal 64 points segments.

Table 3-34: Sequence editor bottom menu

Button	Description
File	Provides side-menu commands for closing the editor, saving the sequence table to the current file name, and saving the sequence data to a new file name.
Data Entry	Provides side-menu commands for inserting a new line in the table as well as entering and editing data in the sequence table columns.
Line Edit	Provides side-menu commands to cut, copy, and paste table lines.
Jump Mode	Provides side-menu commands to select jump mode.
Event Jump	Provides side-menu commands and a new screen for entering event jumps into the sequence table.
Move Cursor To	Provides a pop-up dialog box to specify table line number to select for editing.

Sequence Table Editing

This section describes the sequence table editing.

Cursor Movement

The cursor moves on a cell-by-cell basis. The following text describes how to move the cursor. The instrument highlights the active cell.

- Move the cursor up or down a line by using the general purpose knob, the ▲ and ▼ buttons, or the keyboard keys.
- Move the cursor horizontally along a line by using the ◀ and ▶ buttons or the keyboard keys.
- You can also move the cursor by entering numeric values. This is convenient, for example, when a long sequence results, because more rapid cursor movement is implemented.

Push the **Move Cursor to** bottom button to display the Move Cursor to the dialog box. Input the destination line number in the dialog box, and then push the **OK** side button.

- When you set the value in the Repeat Count, the ◀ and ▶ buttons are assigned to shift the numeric values. To move the cursor horizontally, push the **TOGGLE** or **CLEAR MENU** on the front-panel. Use the ◀ and ▶ button to move the cursor.
- The side menu corresponding to the Data Entry bottom button varies with the parameter value in the cursor position.

Inserting a Line

When you first open a new sequence table, a table containing 0 lines is created. You must insert new lines into the table before you can edit the contents. To insert new lines, use the Insert Line command as follows:

1. Move the cursor to the position that you want to insert a new line. If this is a new table, you are already at the place to insert a new line.
2. Push **Data Entry** (bottom)→**Insert Line** (side).

A new line is created immediately above the line of the current cursor position.

If you insert a new line into a table that contains line jump numbers, the instrument automatically updates the table line numbers and the jump line numbers.

NOTE. *The maximum number of lines in a sequence table is 8000.*

Cutting a Line You can cut a selected line to the paste buffer. Do the following steps to cut a line:

1. Move the cursor to select the line that you want to delete.
2. Push **Line Edit** (bottom)→**Cut Line** (side).

The instrument deletes the selected table line. You can use the Paste Line command to insert the cut line into a new position in the table.

NOTE. After cutting a line from the table, the table automatically updates all current and destination line numbers for jump operations. If you cut a line that was specified as a jump destination, the jump setting is set to Off (no jump). Reinserting the cut line will re-establish the jump connections.

Copying a Line You can copy a selected line to the paste buffer. Do the following steps to copy a line:

1. Move the cursor to the line you want to copy.
2. Push **Line Edit** (bottom)→**Copy Line** (side).

Pasting a Line You can insert the paste buffer contents into the sequence table. Do the following steps to paste a line:

1. Move the cursor to the line you want to insert the paste buffer contents.
2. Push **Line Edit** (bottom)→**Paste Line** (side).

The paste buffer contents are inserted at the selected table line. The contents of the line at the point of insertion, and all subsequent lines, are shifted down by one line.

NOTE. After pasting a new line in the table, the table automatically updates all current and destination line numbers for jump operations.

Sequence Table Fields

- Line** Indicates the line number of each row of the sequence table. The instrument automatically assigns line numbers as well as updates line numbers after editing the sequence table.
- CH 1** Specify the names of the waveform files that are output to the CH1 cells. You can mix and match *.WFM*, *.SEQ*, and *.PAT* files on a single sequence line.

NOTE. Remember that you can only nest sequence files one level. Also, the sequence table cannot call itself as a subsequence.

To specify each file name, select it from the displayed file listing. You must not use a drive or directory name. All waveform files and the sequence file must be under the same directory.

You can also specify a sequence file.

Do the following steps to enter a waveform, pattern, or sequence file name:

1. Move the cursor to **CH1**.
2. Push **Data Entry** (bottom)→**Enter Filename...** (side).
3. The Select File dialog box appears.
From the file listing, select the file to output.
4. Push the **OK** side button.

The instrument inserts the file name into the sequence table.

To delete a specified waveform file, move the cursor to the desired file. Then push **Data Entry** (bottom)→**Clear Filename...** (side).

- Repeat Count** Specify the number of repeats used to cause repetitive output of a waveform on a line. This value may be 1 to 65536. In addition, Infinity may also be specified. When infinity is specified, control will no longer advance. Thus, it should usually be used together with Logic Jump or Table Jump. Do the following steps to enter a repeat count:

Do the following steps to set the repeat count value:

1. Move the cursor to the Repeat Count column.
2. Push **Data Entry** (bottom)→**Repeat Count...** (side).
3. Specify a repeat count value using the general purpose or numeric keys.

Do the following steps if you specify Infinity.

1. Push **Data Entry** (bottom)→**Infinity** (side) to toggle between **On** and **Off**.
2. Alternatively, push the **SHIFT** on the front-panel and then the **INF** numeric key in step 1. Specify the repeat count.

NOTE. The *Infinity* setting is neglected in the subsequence. The general purpose knob is assigned to shift the numeric values when Repeat Count has been set. Push **TOGGLE** or **CLEAR MENU** on the front panel to exit the setting mode.

Wait Trigger

The Wait Trigger column lets you set the instrument to wait for a trigger event before outputting a waveform on the specified sequence table line. Either the Internal or External trigger source will be used, depending on which is selected in the SETUP menu. Valid values are On and Off (blank). Wait Trigger functionality is only valid when the Run Mode is set to Enhanced. Note that this setting is neglected in the subsequence.

The instrument processes sequence table entries until it encounters a Wait Trigger set to ON. If the instrument Run Mode is set to Triggered or Enhanced, the instrument then stops output until it receives a trigger. When the instrument receives a trigger, it outputs the waveform on the sequence table line that contains the Wait Trigger, then continues to process the sequence table lines.

Do the following steps to set the Wait Trigger value:

1. Move the cursor to the line in which to set the Wait Trigger value.
2. Move the cursor to the **Wait Trigger** column.
3. Push **Data Entry** (bottom).
4. Push **Wait Trig.** (side) to toggle between On and Off. The Off state is a blank in the column.
5. Push the **CLEAR MENU** on the front panel to exit the setting mode.

Goto <N>

The Goto <N> column lets you set an unconditional jump to the specified sequence table line. The valid number is 1 to 8000. Goto <N> functionality is only valid when the Run Mode is set to Enhanced. Note that this parameter is ignored if it is set in a subsequence file.

The instrument processes sequence table entries until it encounters a Goto <N>. If the instrument Run Mode is set to Enhanced, the instrument jumps to line one of the table, then continues to process the sequence table lines.

NOTE. By default, the last line of a sequence table always jumps back to line one, unless you have set another jump destination.

Do the following steps to set the Goto <N> value:

1. Move the cursor to the line in which to set the Goto <N> value.
2. Move the cursor to the Goto <N> column.
3. Push **Data Entry** (bottom).
4. **Goto Next** and **Goto Specified Line** menu items are displayed on the side.
5. Push **Goto Specified Line**(side) and enter the value.

The valid number is 1 to 8000.

6. Push the **CLEAR MENU** on the front panel to exit the setting mode.

Logic Jump

The Logic Jump column specifies a conditional jump to a line in the sequence table. Conditional jumps move to a sequence line depending on the value of the TTL logic signals on the EVENT IN rear panel connector. The AWG710B has 7 bits event signals and the AWG710 has 4 bits event signals. The instrument uses event signals to trigger line jumps in the sequence table. Logic Jump functionality is only valid when the Run Mode is set to Enhanced. Note that this setting is neglected in the subsequence.

Figure 3-31 shows the standard 9-pin, D type EVENT IN connector that accepts TTL-level signals (0.0 V to 5.0 V (DC + Peak AC)). The external event input connector lines are pulled to a logic high level when nothing is connected to it.

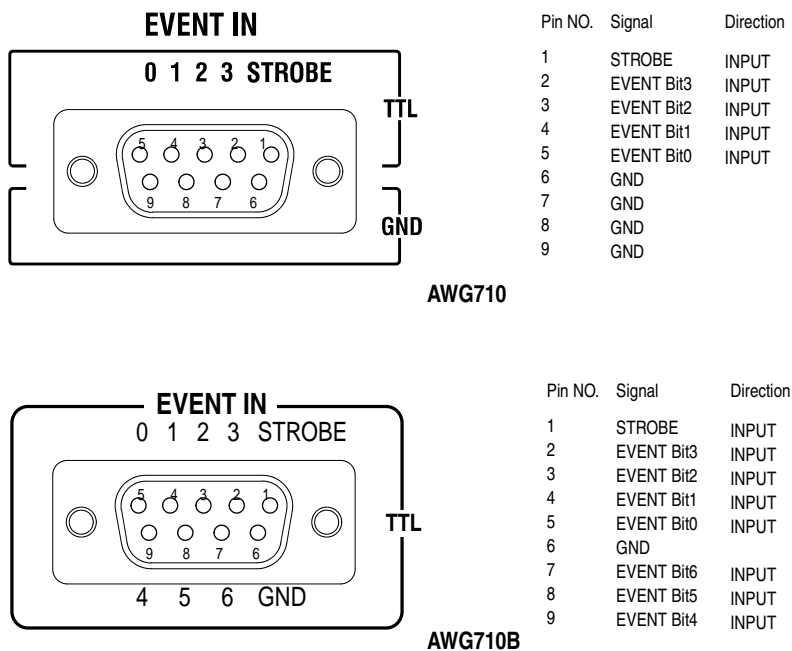

Figure 3-31: EVENT IN connector

You can define two types of conditional jumps: a Logic Jump and a Table Jump. You can also specify whether the jump occurs synchronously or asynchronously, and whether to use an external strobe signal to sample the event values. These features are discussed in the following text.

Logic Jump. The Logic Jump lets you specify the signal values on all four EVENT IN lines for a single event that triggers the jump. You can specify high, low, or don't care values for each line.

Do the following steps to enter a logic jump line number:

1. Move the cursor to the line in which to set the Jump Logic value.
2. Move the cursor to Logic Jump column.
3. Push **Jump Mode** (bottom)→**Logic** (side) to select **Logic**.
The Logic Jump graphic is highlighted.
4. Push **Data Entry** (bottom)→**Jump to Next** (side) to specify a jump to the next line when the event conditions are true.
5. Push **Data Entry** (bottom)→**Jump Off** (side) to clear the Jump Logic table cell. Note that the currently edited line is set as a jump destination in this case.
6. Push **Data Entry** (bottom)→**Jump to Specified Line** (side) and **Jump To** to indicate a jump to a specified line when the event conditions are true.

Use the general purpose knob, front-panel keypad, or keyboard numeric keys to enter a line number.

7. Push **Jump Mode**. The instrument displays the Jump Mode screen.
The Logic jump mode is still selected.
8. Use the general purpose knob, front-panel arrow keys, or keyboard keys to select the logic level for each of the four EVENT IN lines.

X = don't care, L = low (false) logic level, and H = true (high logic level)

Table Jump. The Table Jump lets you specify a line jump for one or more of the 128 = 2^7 ($16 = 2^4$:AWG710) possible logic levels of the EVENT IN lines. Undefined (no line number entered) lines are ignored.

Do the following steps to enter values in the Table Jump table:

1. Move the cursor to the line in which to set the Jump Logic value.
2. Move the cursor to Logic Jump column.
3. Push **Jump Mode** (bottom)→**Table** (side).
The Table Jump graphic is highlighted.
4. Push **Event Jump** bottom button.

5. Use the general purpose knob, the front panel arrow buttons or keyboard arrow keys to select an event logic value line in the table.
6. Push the **Table Jump** side button to **ON** to enable entering a jump line number.

To clear a value, push the **Table Jump** side button to **Off**.

7. Push the **Jump To** side button and then use the general purpose knob, front-panel keypad, or keyboard numeric keys to enter a line number.
8. Repeat steps 5 through 7 to enter jump line numbers for other event table values.
9. Push the **CLEAR MENU** button on the front-panel to return to the sequence table display.

Timing. The Timing function controls when a jump occurs in the waveform output sequence. Selecting ASync causes the instrument to jump to the specified sequence table line as soon as an event goes true.

Selecting Sync causes the instrument to jump to the specified sequence table line after completing the output of the current waveform memory. For example, suppose that an event occurs during the second repeat count of a line on which the waveform is defined to be output three times. The jump occurs after completing the second output repetition and before starting the third output repetition.

To set the timing value in the Event Jump screen, push the **Timing** side menu button to toggle between Sync and ASync.

Strobe. You can set the instrument to enable or disable strobing in the EVENT IN signals. Event signals must be input to the EVENT IN connector on the rear panel when you run the sequence in Enhanced mode. You can input four event signals and one strobe signal in the connector.

When Strobe is set to Off, the instrument reads the event signals at the timing of every two internal clock cycles, and updates the event value if a state transition in the event signals are found.

When Strobe is set to On, the instrument reads the event signals when the strobe signal goes to low state (Enable), and updates the event value if a state transition in the event signals are found.

If you set the strobe signal to low state after all the event signals have finished the state transitions and have been in stable period, the instrument can read the event signal state without error. This prevents an incorrect action in the AWG710&AWG710B Arbitrary Waveform Generator sequence control. Figure 3-32 illustrates an signal timing example.

To enable or disable Strobe functionality in the Event Jump screen, push the **Strobe** side menu button to toggle between On and Off. The strobe setting is saved in the sequence file as an attribute, and used when the sequence is executed. You cannot change this setting while a sequence is being performed.

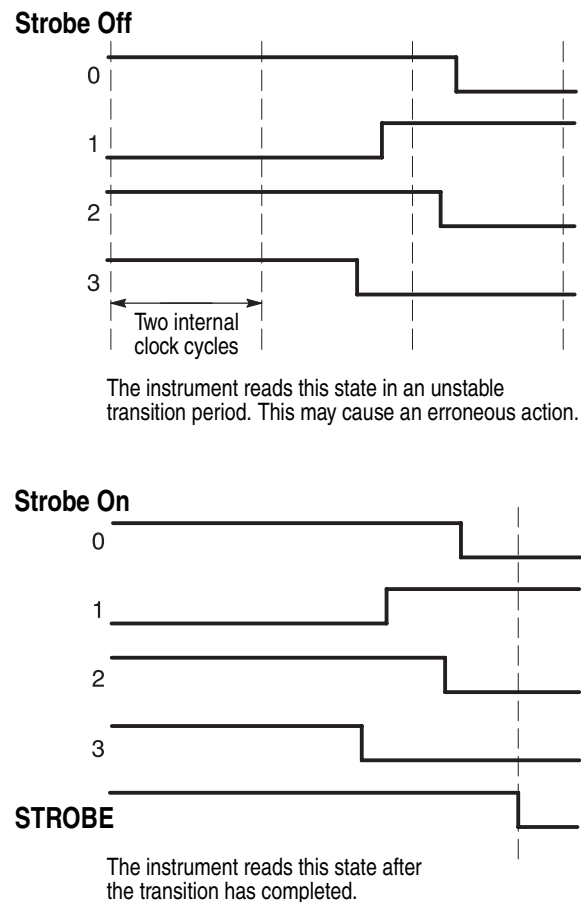

Figure 3-32: Event signal timing and strobe

Software Jump

Software jump can be performed only with the command using a GPIB or Ethernet interface. When you specify a line number as an argument in the command line, the control in the currently loaded sequence file will jump to the specified line.

To perform a software jump, the mode must be set in the loaded sequence file. This can be set in the sequence editor by pushing:

Jump Mode (bottom) → **Software** (side)

For more information, refer to the AWGControl:EVENT:SOFTWARE[:IMMEDIATE] in the AWG710&AWG710B Arbitrary Waveform Generator Programmer Manual.

Limitations on Using Sequences

The sequence is processed by the instrument hardware. The nested sequence, however, is expanded into the sequence memory by the instrument firmware.

The sequence to be recalled from a sequence is called Subsequence, and the nested level is limited to 1. The number of sequence steps expanded in the sequence memory may go over the sequence memory capacity, depending on how you configure the sequence and/or subsequence.

The enhanced settings which include, Infinity, Trigger Wait, Goto <N>, and Logic Jump are neglected in the subsequence when you set the run mode to Enhanced.

Sequence memory usage. Sequence memory controls the maximum number of subsequence recalls and their repeat counts that can be run. When you load a sequence, the AWG710&AWG710B Arbitrary Waveform Generator compiles the sequence and subsequence lines into internal codes that are stored in the sequence memory. The AWG710&AWG710B Arbitrary Waveform Generator then uses the sequence memory code to output the waveform data. There is one internal code item for each sequence line except for lines that contain a subsequence recall.

For subsequence recalls without a repeat count, the AWG710&AWG710B Arbitrary Waveform Generator compiles a number of internal code items equal to the number of lines in the subsequence.

For subsequence recalls with a repeat count, the AWG710&AWG710B Arbitrary Waveform Generator compiles a number of internal code items. These are equal to the repeat count for that subsequence call times the number of lines in the subsequence. For example, if a sequence line has a subsequence recall with the repeat count of 25 and that subsequence has two lines, the AWG710&AWG710B Arbitrary Waveform Generator generates 50 internal code items for that sequence line and stores them in the sequence memory. This occurs for each subsequence call. Figure 3-33 illustrates how the AWG710&AWG710B Arbitrary Waveform Generator compiles the sequence and subsequences into the internal codes and stores them in the sequence memory.

Sequence and subsequence example

Suppose that the waveform file: BK1.WFM,, BK2.WFM, BK3.PAT, BK5.WFM and BK7.WFM has been created in the waveform memory.

Sequence:

BK1.WFM	6
SUB8.SEQ	25
BK2.WFM	1
SUB8.SEQ	15
BK3.PAT	4
SUB8.SEQ	5

Subsequence call

Compile

Subsequence: SUB8.SEQ

BK7.WFM	2
BK5.WFM	3

Internal code image in the sequence memory

BK1.WFM	Repeat 6
BK7.WFM	Repeat 2
BK5.WFM	Repeat 3
...	
BK7.WFM	Repeat 2
BK5.WFM	Repeat 3
BK2.WFM	Repeat 1
BK+7.WFM	Repeat 2
BK5.WFM	Repeat 3
...	
BK7.WFM	Repeat 2
BK5.WFM	Repeat 3
BK3.PAT	Repeat 4
BK7.WFM	Repeat 2
BK5.WFM	Repeat 3
...	
BK7.WFM	Repeat 2
BK5.WFM	Repeat 3

} 25 times
 } 15 times
 } 5 times

Figure 3-33: Compiling and storing sequences and subsequences

Defining subsequence calls with large repeat counts can generate internal code that consumes a large amount of sequence memory. This can result in insufficient memory errors. The AWG710&AWG710B Arbitrary Waveform Generator does not check for sequence memory availability errors. If you load a sequence and the AWG710&AWG710B Arbitrary Waveform Generator displays a memory error message, you need to reduce the number of subsequence calls, the number of repeat counts, and/or the number of lines in the subsequences.

The APPL Menu

The following applications are in the APPL menu:

- Disk application
- Network application
- Jitter composer

These applications are used like an editor to generate a waveform for specific purposes.

Disk Application

Using this application, you can easily create test signals for reading or writing data from/to hard disk media.

Signals are created using the following process:

- Input binary bit pattern expressed by 0 and 1.
- Convert the input pattern and estimate the positions of the generated pulse and polarity.
- Superpose an isolated pulse in the position estimated above. The pulses shift during superpose.

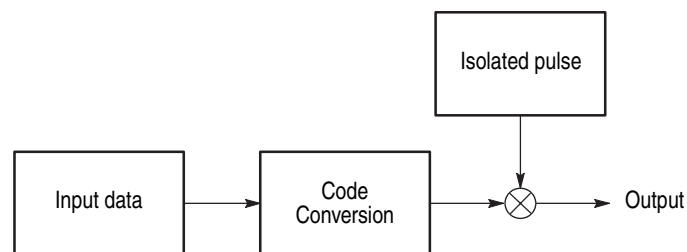

Figure 3-34: Outline flow for producing HDD reading test signal

- Operation Flow**
1. Select **APPL** (front-panel)→**Application** (bottom)→**Disk** (side) to display the Disk Application screen. See Figure 3-35.

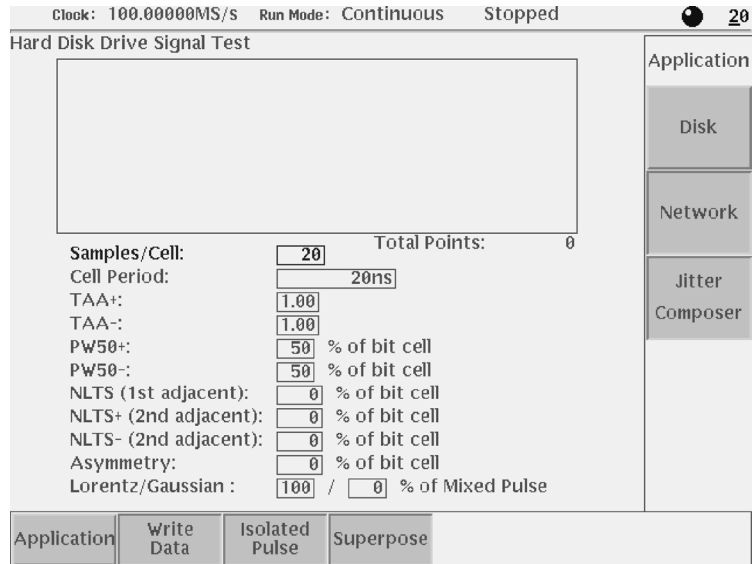

Figure 3-35: Disk application initial screen

2. Select **Write Data** (bottom)→**Read from File...** (side) or →**Pre-defined Pattern** (side) to display the dialog box for input data selection.
3. Select a file or pre-defined pattern.

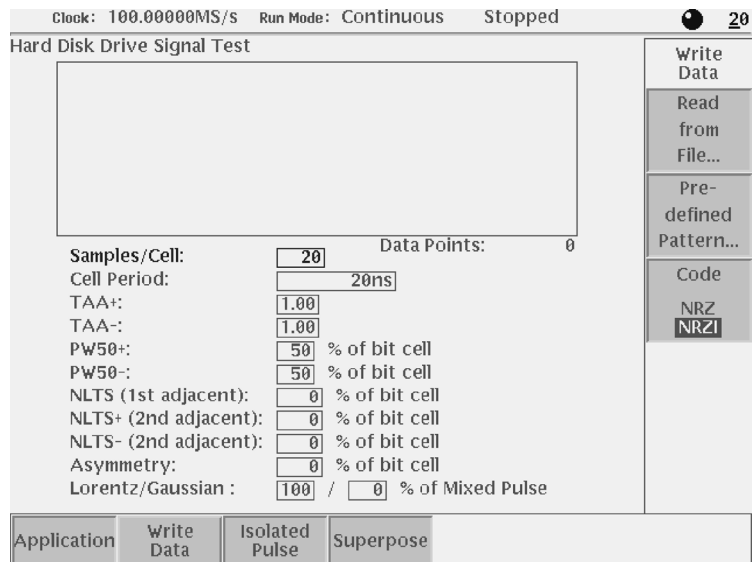

Figure 3-36: Writer Data menu

- Press **Isolated Pulse** bottom button, and select an isolated pulse from the side menu.

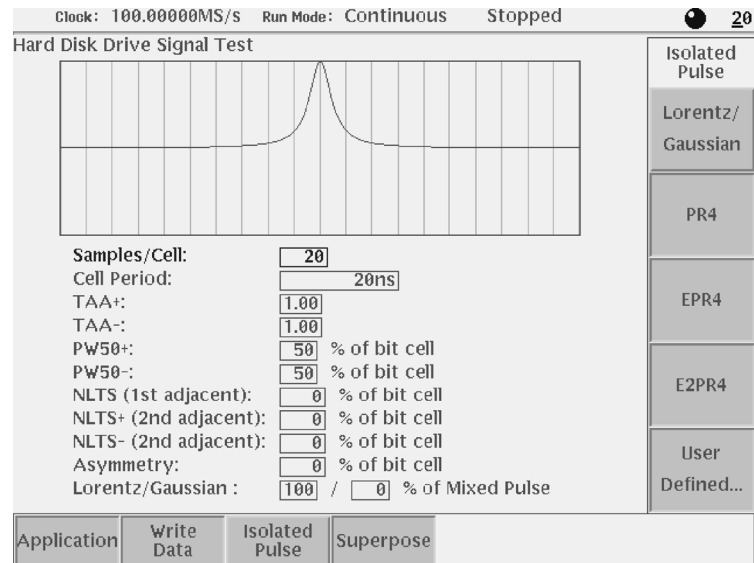

Figure 3-37: Isolated Pulse menu

- Set the parameters displayed on the menu screen.
- Select **Superpose** (bottom)→**Execute** (side) to execute superposing. The generated waveform is displayed in the menu screen window.

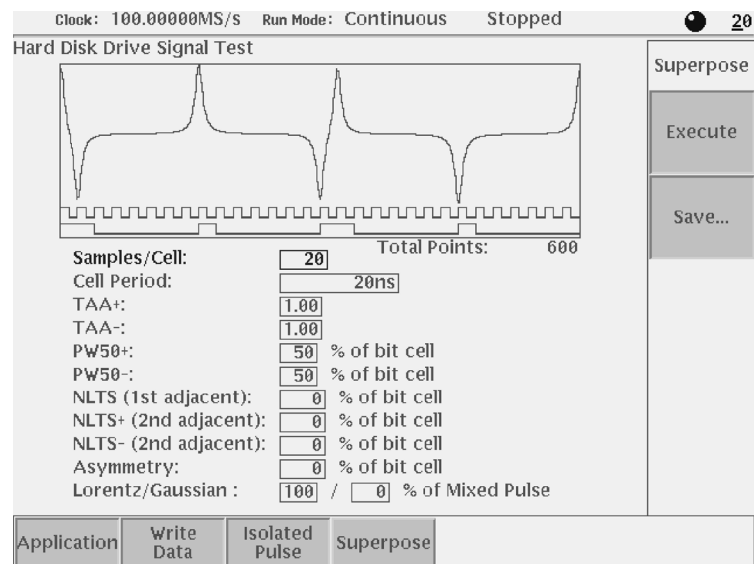

Figure 3-38: Execution of superpose

7. If needed, you can repeat adjusting the superpose parameters in this screen and generate new output waveform.
8. Select **Superpose** (bottom)→**Save...** (side) to save the generated waveform to a file.

Input data

The specified pattern or waveform file is used as input data. When a pattern data file is specified for input, the application reads only the MSB bits (DATA7). When a waveform file is specified, this process converts the values equal to or greater than 0.5 to a logic 1, and the values less than 0.5 to a logic 0.

NOTE. *One restriction is applied to the number of input data points;
input data points > isolated pulse data points / (Samples/Cell)*

The pre-defined patterns shown in Table 3-35 are incorporated in the application:

Table 3-35: Pre-defined patterns

Pattern items	Descriptions
$X^{15} + X + 1$	15-bit M-series pseudo random pulse
$X^9 + X^5 + 1$	9-bit M-series pseudo random pulse
$X^7 + X^3 + 1$	7-bit M-series pseudo random pulse
32'1's	32-bit wide data in which all bits are set to 1
Harmonic Elimination Pattern	The pattern's 5th harmonic component is set to 0. 110000001000000110000001000000

Code Conversion

This part inputs the binary bit pattern and converts the transition from 1 to 0 or 0 to 1 to a series of positive and negative pulse. Table 3-36 lists the available code conversion types:

Table 3-36: Code Conversion

Code conversion	Descriptions
NRZ	Converts a transition from 0 to 1 to a positive pulse, and from 1 to 0 to a negative pulse. This conversion considers the input data as representing a direction of magnetization.
NRZI	Generates a pulse when the input data is 1. The first pulse is always positive, and after this, the pulse polarity toggles for every input data value of 1. This conversion considers the input data as representing the disk writing data.

Isolated Pulse Isolated pulse lets you superpose a pulse onto the converted code. You can select from the following five pulse types:

- Lorentz/Gaussian pulse

Isolated pulse is created by the mixture of two types waveforms; Lorentz and Gaussian. You can adjust mixture rate through Lorentz/Gaussian: parameters displayed in the lower part of the screen.

When you adopt complete Lorentz waveform as an isolated pulse, set the parameter to [100] / [0]%. When you adopt Gaussian waveform as an isolated pulse, set the parameter to [0] / [100]%.

Mixed waveform is acquired by adding two formulas which have same PW50 and normalizing the calculated value. Each formula is set to L(x) and G(x), and the mixture rate is set to a and b respectively.

$$\text{Isolated pulse: Normalize } (a*L(x) + b*G(x)) \\ (a + b = 1.0)$$

- PR4 pulse
- EPR4 pulse
- E2PR4 pulse
- User defined pulse

You can define isolated pulse. Create user-defined waveform on the internal disk. There are two options for creating user-defined file; using editor or using signals acquired by oscilloscope. Follow the procedures described below to create the isolated pulse.

Creating Isolated Pulse

Two parameters are important to create an isolated pulse.

- Number of points for 1 bit

Samples/Cell parameter is displayed on the Disk application screen. This represents the number of points for one bit of disk waveform. Isolated pulse must correspond to this parameter value.

- Total points of the isolated pulse

Total number of points that make up the isolated waveform should be set to four times of values given by Samples/Cell parameter. The maximum number of points is smaller than the value calculated by the two parameters: data points specified by Write Data(bottom) Pre-defined Pattern... or Read From File... and the value specified by Samples/Cell parameter. In other words, the maximum number of points is smaller than the number of points after the application performs superposition.

Using formula.

Use the following formula to specify the values when the waveform is acquired from calculation.

Peak value:	Center (Except for shifting the value intentionally)
PW50:	(Samples/cell)/2
Waveform size:	(Samples/cell)*4

For example, you use Lorentz waveform, specify the formula as follows;

cells = 10	'Samples/cell ==> 10
size = cells * 4	'Number of total waveform points
pw = cells / 2	'Pulse width at half level
clock = 1e9	'AWG clock that needs to calculate
ppw = pw / clock	'Pulse width for calc.
pposit = size / 2 / clock	'Peak position for calc.
"Lorentz.wfm" = 1/(1+(2*(time - pposit)/ppw)^2)	

Using acquired waveform file.

You can create isolated waveform from signals acquired through the oscilloscope or other equipment by using the waveform editor.

When acquiring the signals, it is not necessary to observe the number of points or PW50. However, it is required to set the pulse edge to 0 (zero). When you use the waveforms from the oscilloscope, it is recommended to adjust the edge to zero level.

Use the following steps to modify the waveform.

First, you need to extract the pulse.

1. Open the acquired waveform by waveform editor.
2. Locate the pulse which you want to extract, then move the left-cursor to the center of pulse.
3. Expand the display by using Zoom function as necessary.
4. Specify the range of pulse you want to extract.

After specifying the range, check the number of points that make up the PW50. Set the total number of points to eight times of PW50(in this case, the PW50 is set to 50%).

5. Locate the left-cursor to 0, the right-cursor to 1 point left of the pulse you want to extract. Then, delete unnecessary data on the left side of the pulse by using **Operation** (bottom) → **Cut** (pop-up).
6. Locate the right-cursor to the maximum point of the waveform, the left-cursor to 1 point right of the pulse you want to extract. Then, delete unnecessary data on the right side of the pulse by using **Operation** (bottom) → **Cut** (pop-up).

This completes the extraction of pulse you want to create.

Next, you need to adjust the total number of points.

7. Check the number of points that make up the PW50 you extracted (acq_pw).
8. Check the total number of points that make up the extracted pulse (acq_size).
9. Check the value given by Samples/Cell parameter (cells).
10. Specify the total number of points that make up the isolated waveform you want to create(size).

Use the following formula when PW50 is 50%.

$$\begin{aligned}pw &= \text{cells}/2 \\ \text{size} &= (\text{pw}/\text{acq_pw}) * \text{acq_size}\end{aligned}$$

11. Press **Tools** (bottom) → **Re-Sampling** (pop-up) to open menu.
12. Specify the value of size calculated by New Points and press **OK** (side) button. Now you have got the isolated waveform.
13. Save the isolated waveform you created by using appropriate name.

This completes the creation of user-defined isolated waveform.

Superpose Parameters

The superpose parameters are used to define an isolated pulse waveform and a quantity for shift. Table 3-37 lists the superpose parameters.

Table 3-37: Superpose parameters

Parameters	Descriptions
Samples/Cell	Specifies the number of waveform points to be generated for each point of the input data.
Cell Period	Specifies the cell period.
TAA+ and TAA-	Specifies the pulse width of the positive and negative isolated pulse. The setting range is from 0 to 1.0 in steps of 0.01. The maximum amplitude is 1.0.
PW50+ and PW50-	Specifies the half-width of the pulse as a percentage of the cell. The setting range is from 0 to 200 in step 1. This parameter cannot be set for the PR4, EPR4 and E2PR4.
NLTS	When the pulse is generated continuously, this parameter shifts the pulses from the second one onward. Set the quantity of the shift to this parameter in the percentage of the cell. The setting range is from -100 to 100 in step 1.
NLTS+ and NLTS-	Shifts the current pulse depending on whether the pulse existed or not in two data position advance. The setting range is from -100 to 100 in step 1. When the current pulse has the same polarity as the pulse in two data position advance, the current pulse is shifted backward by the value represented by this parameter (NLTS-). When the current pulse has the different polarity, it is shifted forward by this parameter (NLTS+). The total quantity of shift can be calculated by mixing the value of NLTS+, NLTS- and NLTS.
Asymmetry	Shift the positive pulse forward and the negative pulse backward by the value specified by this parameter. The setting range is from -100 to 100 in step 1.
Lorentz/Gaussian	Specifies the mixture ratio of Lorentz and Gaussian pulse by unit of % as an isolated pulse. Sum of two values within the boxes is always equal to 100. Setting one value to 100 specifies complete the Lorentz or Gaussian pulse. This parameter can be performed only when you select Lorentz/Gaussian as an isolated pulse.

Generating Waveform

The magnetic disk reading waveform is generated based on the input data, isolated pulse, and superpose parameters. To generate a waveform, select **Superpose** (bottom)→**Execute** (side).

The square pattern with the period of one cell is set in Marker 1. The input data is set in Marker 2.

Isolated pattern is calculated for only 20 cells, and the other part is considered to be 0.

For the isolated pulse, wraparound is included in the calculation in superposition, assuming that this waveform repeats. However, the calculation is not made for the second and subsequent cycles of wraparound. Therefore, the correct calculation is not made for input data shorter than the isolated pulse length (20 cells).

NOTE. One restriction is applied to the number of input data points;
 $input\ data\ points > isolated\ puls\ data\ points / (Samples/Cell)$

The NLTS calculation requires the position of the previous pulse, which cannot be obtained from the initial part of input data. Also for this problem, information is obtained with wraparound by using the last part of input data.

Saving to File

You can save the generated waveform to a file. If the waveform length does not satisfy the instrument file length conventions, the instrument repeats the data several times and regenerates the waveform to create a valid file.

Network Application

This application creates a network test signal to analyze the various standard network signals.

The signals are created using the following process:

- Input binary bit pattern expressed by 0 and 1.
- Convert the input pattern using the standard-defined code and estimate the positions where pulse will be generated and its polarity.
- Superpose a standard-defined isolated pulse in the position estimated above.

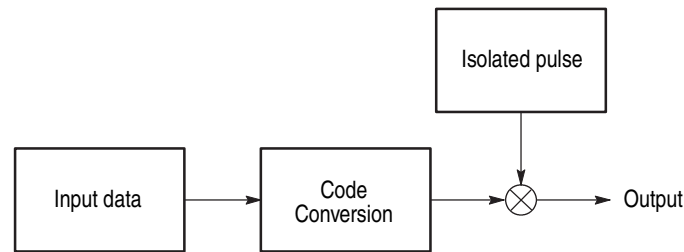

Figure 3-39: Outline flow for producing network test read signal

Operation Flow

1. Select **APPL** (front-panel)→**Application** (bottom)→**Network** (side) to display the Network Application screen. See Figure 3-40.

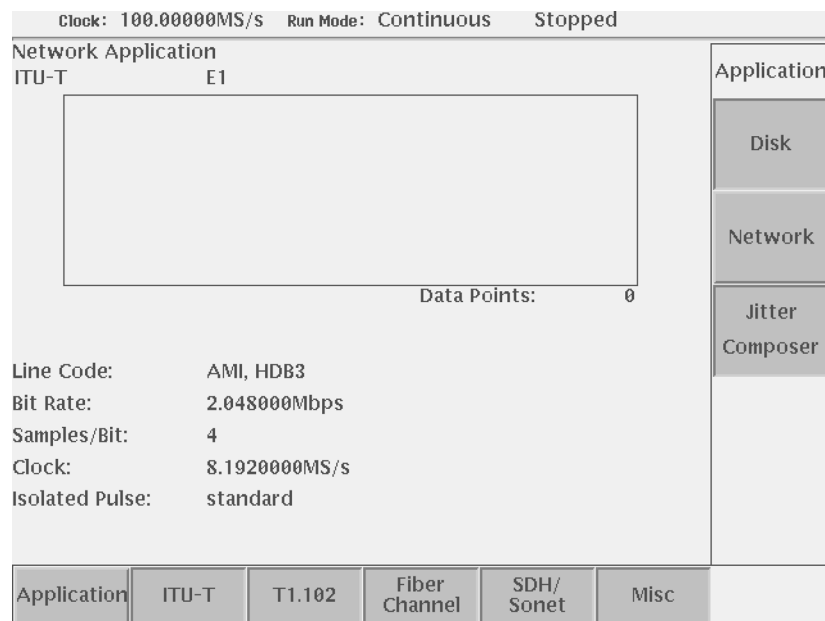

Figure 3-40: Network application initial screen

2. Select a standard network signal by pressing either bottom button, selecting subordinate standard item from the pop-up menu, and press the **OK** side button.

The side menu will change. See Figure 3-41.

3. Select a file or pre-defined pattern as a input data by pressing **Read Ptn from File...** (side) or **Pre-defined Pattern...** (side).

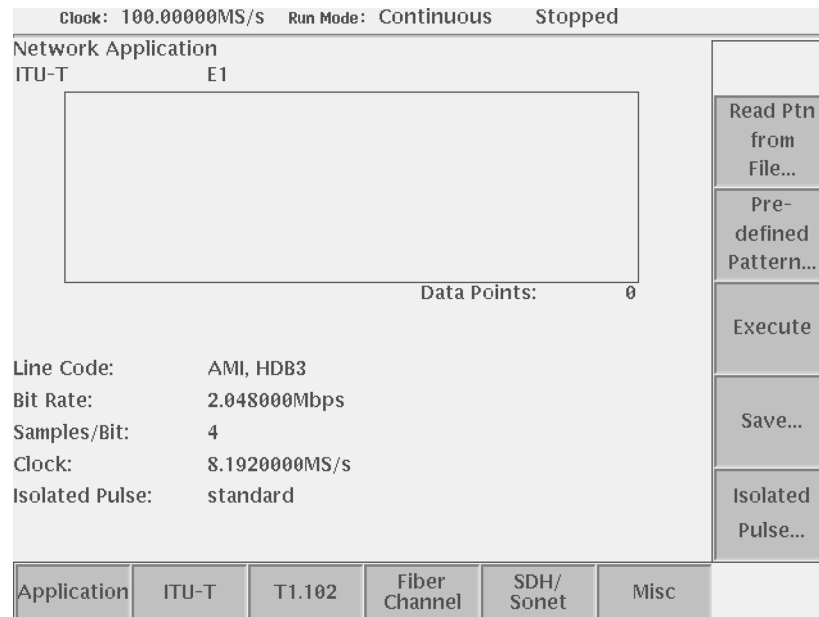

Figure 3-41: Side menu will change after selecting a standard

When you select one of ITU-T E1, E2, E3, T1.102 DS1, DS1A, DS1C, DS2, DS3, STS-1 as a standard, you can use user defined isolated pulse.

4. Press **Isolated Pulse...** side button. The side menu will change.

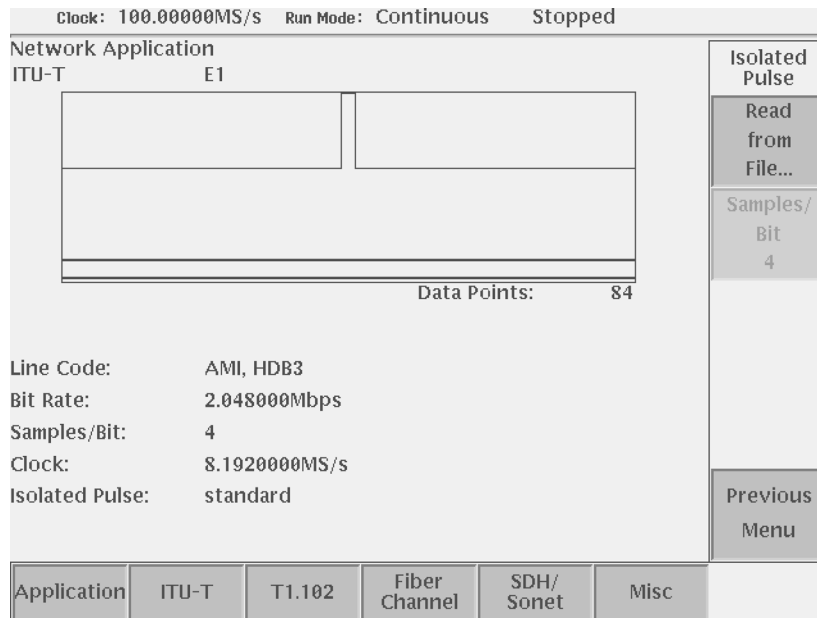

Figure 3-42: Side menu for selecting the Isolated pulse

5. Press **Read from File...** side button. The side menu will change.
6. Select a waveform file from the file list as a isolated pulse.
7. **Samples/Bit** side button will be enabled. Select a value from 1, 2, 4, 8, 16, 32, 64.
8. Press **Previous Menu** side button to return Figure 3-41.
9. Press **Execute** side button to execute superposing.
The generated waveform is displayed in the menu screen window.

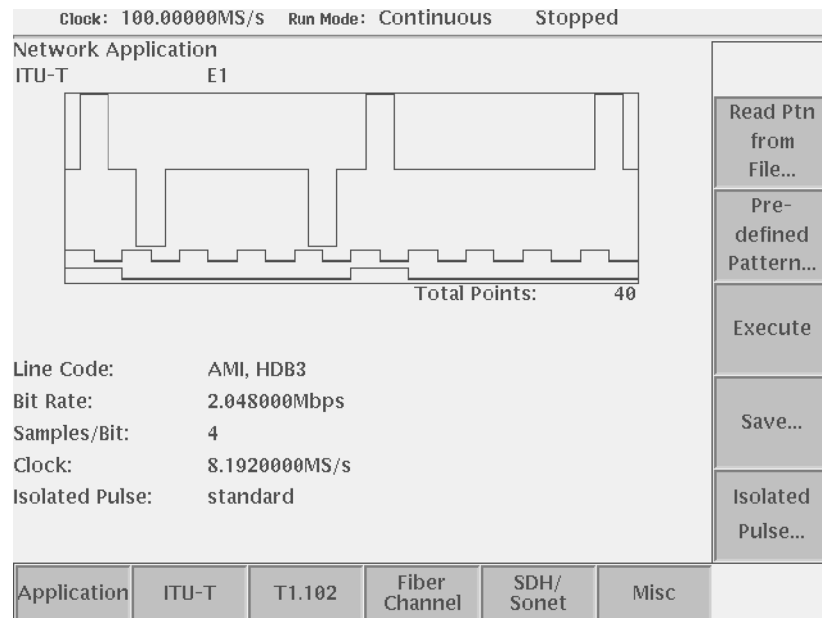

Figure 3-43: Execution of superposing

10. Select **Superpose** (bottom)→**Save...** (side) to save the generated waveform to a file.

Input data

Pattern data file or waveform file is used as input data. When a pattern data file is specified for input, the application reads only the MSB bits (DATA7). When a waveform file is specified, this process converts the values equal to or greater than 0.5 to a logic 1, and the values less than 0.5 to a logic 0.

The pattern data or waveform data to be input must have the number of points equal to or more than 20 points.

The pre-defined patterns shown in Table 3-38 are incorporated in the application:

Table 3-38: Pre-defined patterns

Pattern items	Descriptions
PN9	9-bits M-series pseudo random pulse
PN15	15-bits M-series pseudo random pulse
0000	
1111	
100100	
10001000	
1000010000	
100000100000	
1000000010000000	
1111100000	

Line Code Conversion

Line code conversion inputs the binary bit pattern and converts the transition from 1 to 0 or 0 to 1 to a positive or negative pulse. Table 3-39 lists the standard defined code conversions.

Table 3-39: Code conversion

Code conversion	Descriptions
CMI (Code Mark Inversion)	Last level: Low Level of the last binary 1: High
B6ZS, B8ZS (Bipolar with Eight Zero Substitution)	Polarity of the last pulse: Negative Number of successive 0: 0
B3ZS, HDB3 (High Density Bipolar 3)	Polarity of the last pulse: Negative Number of successive 0: 0 Number of B pulse: 1
MLT-3 (High Density Bipolar 3)	Initial level: 0, First output nonzero level: 1

Isolated Pulse

The standard-defined isolated pulse is used. You do not need to set a pulse.

When the Line Code is a AMI standard (ITU-T E1, E2, E3, T1.102 DS1, DS1A, DS1C, DS2, DS3, STS-T), an user defined waveform file can be used as an isolated pulse. The length of isolated pulse has no restriction.

Superpose Parameters

Table 3-40 lists the standard defined superpose network parameters.

Table 3-40: Network parameters

Standard	Line code	Bit rate	Samples/ bit	Clock
ITU-T STM1E	CMI	155.5200 Mbps	2	311.0400 MS/s
E5 CEPT	NRZ	565.0000 Mbps	1	565.0000 MS/s
E4	CMI	139.264000 Mbps	2	278.52800 MS/s
E3	AMI, HDB3	34.368000 Mbps	4	137.47200 MS/s
E2	AMI, HDB3	8.448000 Mbps	4	33.79200 MS/s
E1	AMI, HDB3	2.048000 Mbps	4	8.19200 MS/s
T1.102 STS-3	CMI	155.520000 Mbps	2	311.04000 MS/s
STS-1	AMI, B3ZS	51.840000 Mbps	16	829.44000 MS/s
DS4NA	CMI	139.264000 Mbps	2	278.52800 MS/s
DS3	AMI, B3ZS	44.736000 Mbps	16	715.77600 MS/s
DS2	AMI, B6ZS	6.312000 Mbps	32	201.98400 MS/s
DS1C	AMI, B8ZS	3.152000 Mbps	4	12.60800 MS/s
DS1A	AMI, HDB3	2.084000 Mbps	32	66.68800 MS/s
DS1	AMI, B8ZS	1.544000 Mbps	32	49.40800 MS/s
Fiber Channel				
FC1063E	NRZ	1062.5000 Mbps	1	1062.5000 MS/s
FC531E	NRZ	531.2000 Mbps	1	531.2000 MS/s
FC266E	NRZ	265.6000 Mbps	1	265.6000 MS/s
FC133E	NRZ	132.8000 Mbps	1	132.8000 MS/s
SDH/Sonet				
OC48 / STM16	NRZ	2488.3000 Mbps	1	2488.3000 MS/s
OC36	NRZ	1866.2000 Mbps	1	1866.2000 MS/s
OC24	NRZ	1244.2000 Mbps	1	1244.2000 MS/s
OC18	NRZ	933.1200 Mbps	1	933.1200 MS/s
OC12/STM4	NRZ	622.0800 Mbps	1	622.0800 MS/s
OC3/STM1	NRZ	155.5200 Mbps	1	155.5200 MS/s
OC1/STM0	NRZ	51.8400 Mbps	1	51.840 MS/s
Misc				
FDDI	NRZ	125.0000 Mbps	1	125.0000 MS/s
100 Base-TX	MLT-3	125.0000 Mbps	1	125.0000 MS/s
Gigabit Ethernet	NRZ	1250.0000 Mbps	1	1250.0000 MS/s

Table 3-40: Network parameters

Standard	Line code	Bit rate	Samples/ bit	Clock
D2	NRZ	143.1800 Mbps	1	143.180 MS/s
D1	NRZ	270.0000 Mbps	1	270.000 MS/s

Generating Waveform

The network test reading waveform is generated based on the input data, isolated pulse, and superpose parameters. To generate a waveform, press the **Execute** side button.

The clock frequency is the same as the bit rate is set in the Marker 1. When the sample rate is 1, the clock frequency that is half the bit rate is set in Marker 1. The input data is set in Marker 2.

NOTE. *The clock attribute of a generated waveform is the one defined in the standard.*

Saving to File

You can save the generated waveform to a file. If the waveform length does not satisfy the instrument waveform file length conventions, the instrument repeats the data several times and regenerates the waveform to create a valid file.

Jitter Composer Application

This application creates signals with jitter and Spread Spectrum Clock (SSC) relative to bit-pattern.

Signals are created using the following process:

- Input binary bit pattern expressed by 0 and 1.
- Create data for one period by sorting bit pattern in the direction of time base using parameters.
- Deviate the data for one period in the direction of time base along Jitter Profile.

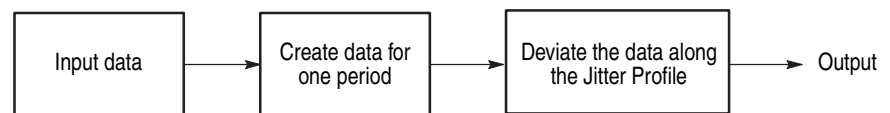

Figure 3-44: Outline flow for Jitter waveform creation

- Operation Flow**
1. Select **APPL** (front-panel)→**Application** (bottom)→**Jitter Composer** (side) to display the Jitter Composer. See Figure 3-47.

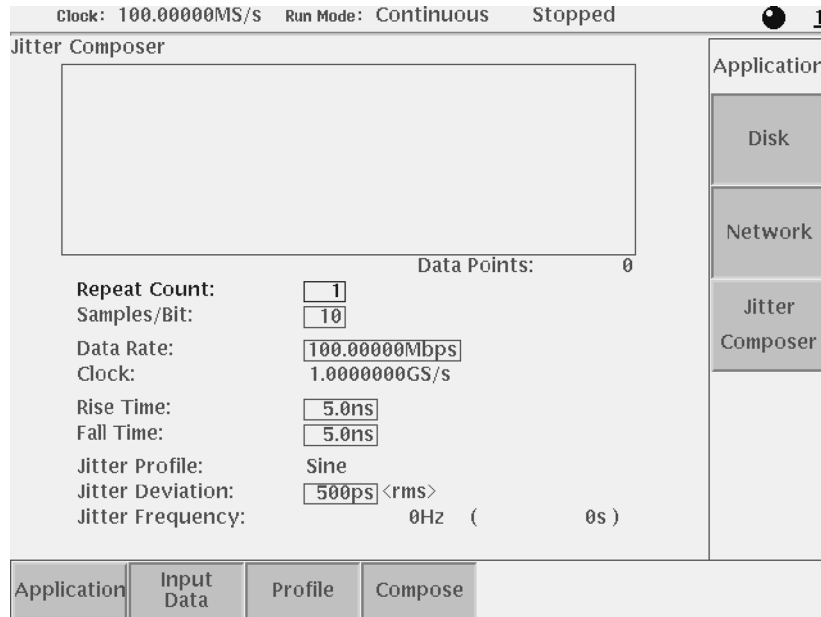

Figure 3-45: Jitter composer application initial screen

Specify input data. Load waveform/pattern files or use a pre-defined pattern.

2. Select **Input Data** (bottom)→**Read from File...** (side) or →**Pre-defined Pattern** (side) to select input data.

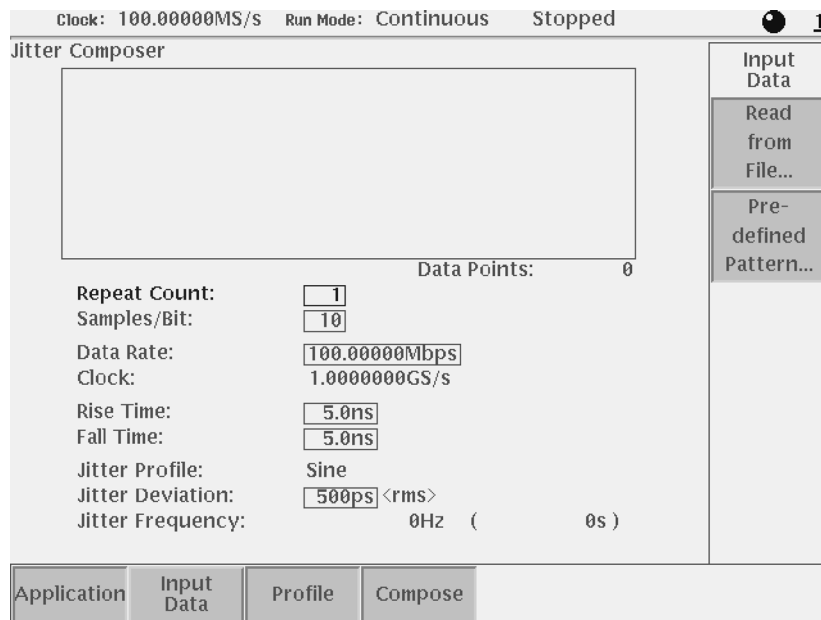

Figure 3-46: Input Data menu

3. Select a waveform/pattern file from the file list to load the waveform/pattern file, or select a pre-defined pattern from the pattern list to load the pre-defined pattern.

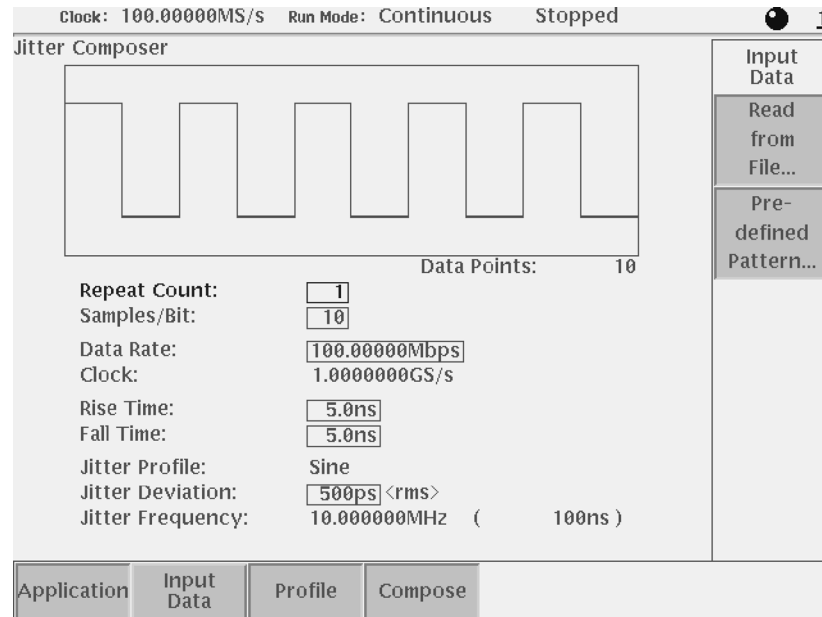

Figure 3-47: A pre-defined pattern was selected as an input data

4. Set the parameters displayed on the menu screen.
5. Press **Profile** (bottom) → **Sine**, or **Triangle** (side) button to select the jitter profile.

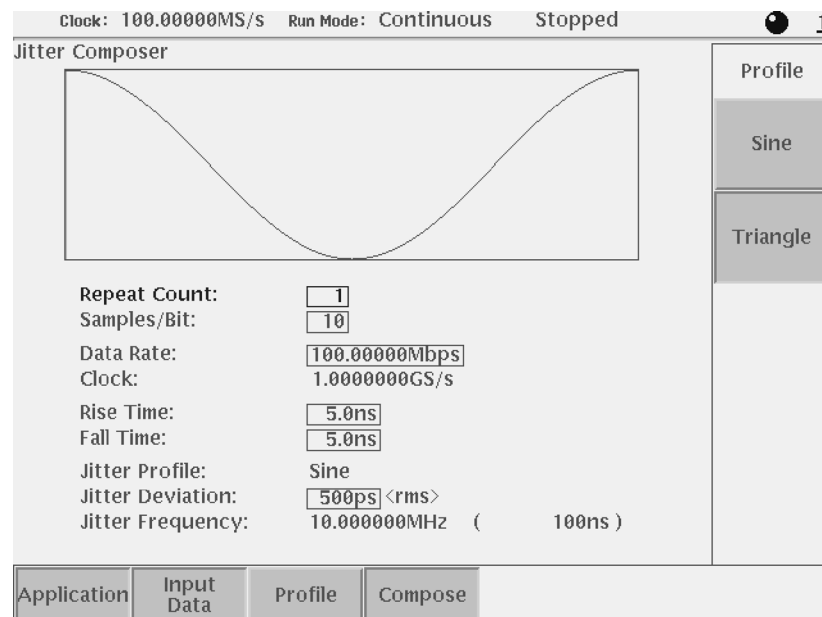

Figure 3-48: Jitter profile menu

6. Select **Compose** (bottom)→**Execute** (side) to generate the jitter waveform.
The generated waveform is displayed in the menu screen window.

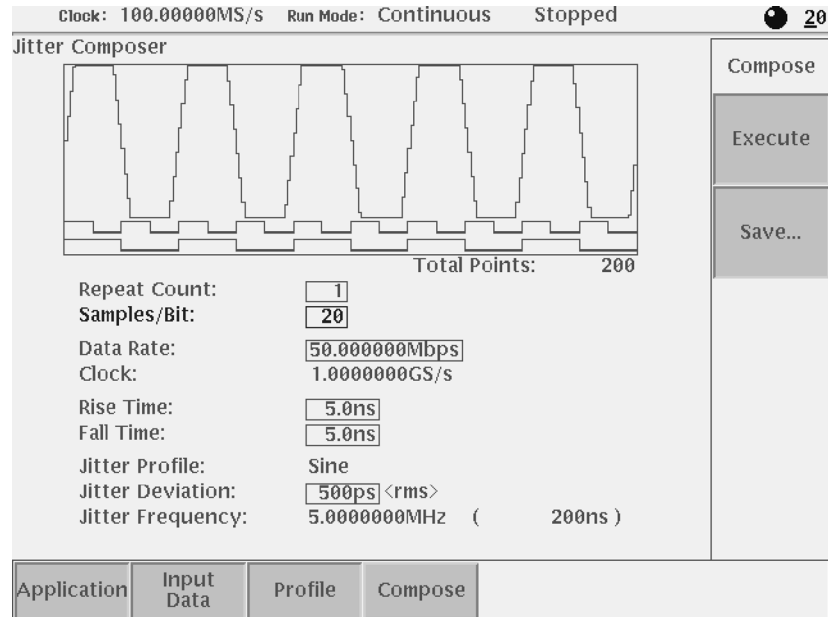

Figure 3-49: Execution of jitter composer

7. Change each parameter and press Execute (side) menu button to generate new output jitter waveform.
8. Select **Compose** (bottom)→**Save...** (side) to save the generated waveform in a file.

Input data The specified pattern or waveform file is used as input data. When a pattern data file is specified for input, the application reads only the MSB bits (DATA7). When a waveform file is specified, this process converts the values equal to or greater than 0.5 to a logic 1, and the values less than 0.5 to a logic 0.

The Pre-defined patterns shown in Table 3-41 are incorporated in the application:

Table 3-41: Pre-defined patterns

Pattern items	Descriptions
PN9	9-bits M-series pseudo random pulse.
PN15	15-bits M-series pseudo random pulse.
100100	
10001000	
1000010000	
1010101010	
100000100000	
1000000010000000	

Jitter composer parameters

The following parameters are provided to be specified when you generate a jitter waveform.

Some parameters such as Clock and Jitter Frequency, are uniquely defined by other parameters, and only displayed on the screen. You can not address these parameters directly.

You can change any other parameter whenever it is displayed on the screen regardless of selected bottom menu.

Table 3-42: Jitter composer parameters

Parameters	Descriptions
Repeat Count	Specifies the repetition number of original waveform points that makes up one period for jitter waveform.
Samples/Bit	Specifies the number of points to be generated for each point of the input data. The value is larger than 2 because the input data needs rise time and fall time.
Data Rate [bps]	Specifies the data rate for jitter waveform. This value is prior to Samples/Bit, Rise Time, and Fall Time.
Clock [Samples/s]	Display clock rate (display only). The clock rate is automatically set by $\text{Data Rate} \times \text{Samples/Bit}$.
Rise Time	Specifies rise time of pulse (time between points of 10% and 90% level of amplitude). You can select 0(zero). One restriction is applied to Rise Time parameter; $\text{Rise Time} + \text{Fall Time} \leq 1/\text{Data Rate} \times 2 \times 4/5$.
Fall Time	Specifies fall time of pulse (time between points of 10% and 90% level of amplitude). You can select 0(zero). One restriction is applied to Fall Time parameter; $\text{Rise Time} + \text{Fall Time} \leq 1/\text{Data Rate} \times 2 \times 4/5$.
Jitter Profile	Specifies the deviation of each point for one period in the direction of time base. Use Profile(bottom) → Sine, Triangle (side) menu to select among sine wave and triangle wave.
Jitter Deviation	Specifies the deviation of jitter waveform. Suppose 10101010.....repetitive pattern as an input data, and one 1,0 pair as one period of pattern, this value represents the equivalent deviation for one 1,0 pair. ¹
Jitter Frequency	Display repeated frequency of jitter waveform. This value is automatically set by $\text{Clock} / \text{Total Points}$.
Data Points	Display the number of points for input data (display only).
Total Points	Display the number of points for jitter waveform (display only). This value is automatically set by $\text{Data Points} \times \text{Repeat Count} \times \text{Samples/Bit}$.

¹ Jitter deviation on peak-to-peak is ;
 profile = sine : about 2.83 times of jitter deviation on rms.
 profile = triangle : about 3.46 times of jitter deviation on rms.

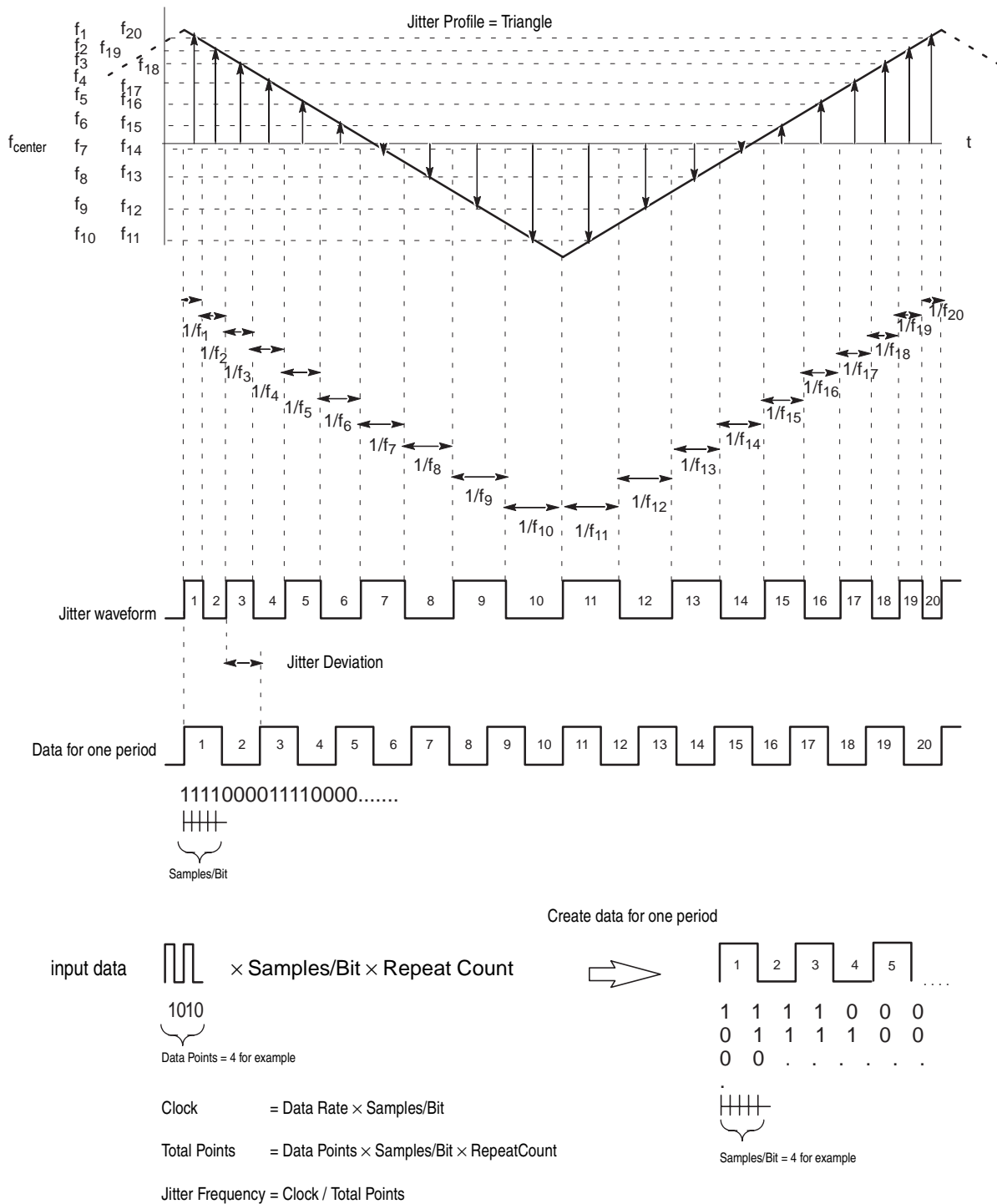

Figure 3-50: Jitter parameters and jitter waveform

Generating Waveform

The jitter waveform is generated based on the input data and jitter parameters described above. To generate a waveform, select **Compose** (bottom)→**Execute** (side).

The clock whose frequency is the same as the Bit Rate is set in Marker 1. The input data is set in Marker 2.

Saving to File

You can save the generated waveform to a file. If the waveform length does not satisfy the instrument file length conventions, the instrument repeats the data several times and regenerates the waveform to create a valid file.

The UTILITY Window

This section describes the utility settings that can be made to the AWG710&AWG710B Arbitrary Waveform Generator.

- Using external keyboards
- Setting general purpose knob direction
- Formatting floppy disk
- Displaying disk usage
- Screen display enable/disable
- Setting the focused color
- Displaying instrument status
- Setting the Internal clock (date and time)
- Resetting the instrument
- Connecting to GPIB network
- Connecting to Ethernet
- Setting up hardcopies
- Running calibration and diagnostics
- Upgrading the system software

External Keyboards

You can connect either an ASCII 101-key keyboard or a JIS (Japanese) 106-key keyboard to the keyboard connector on the rear panel. Do the following steps to let the AWG710&AWG710B Arbitrary Waveform Generator know the type of keyboard being used:

1. Push the **UTILITY** (front-panel)→**System** (bottom).
2. Select **Keyboard Type**: using the ▲ and ▼ buttons.
3. Select **ASCII** or **JIS** using the general purpose knob.

The changes take effect immediately.

About Key Operation

You can use the PC keyboard for menu operations rather than using the instrument front panel keys or buttons. Use the keyboard to input the file name, directory name, and text in the Text/Equation editors. The PC keyboard character keys, ten keys, arrow keys, space key and shift key can be used in place of the front panel keys, buttons, and some menu operation commands. Table 3-43 lists other edit operations you can perform from the PC keyboard.

Table 3-43: External keyboard edit operations

Control keys	Descriptions
Character and numeric keys	Characters found in the character palette can be input from the corresponding keys on the keyboard.
◀ and ▶ keys	Corresponds to the front-panel ◀ and ▶ keys. The caret moves horizontally when using the equation editor.
▲ and ▼ keys	Corresponds to the front-panel ▲ and ▼ keys. The caret moves vertically when using the equation editor.
Delete	Deletes a character to the right of the caret.
Backspace	Deletes a character to the left of the cursor.
Ctrl-C	Copy
Ctrl-X	Cut
Ctrl-V	Paste
Ctrl-Z	Undo
Ctrl-S	Toggles the selection on and off.

Setting General Purpose Knob Direction

Use the general purpose knob to highlight items in the pop-up menu or file list. The default setting for the knob rotation is clockwise for down (backwards) and counterclockwise for up (forward).

- Turning the knob clockwise causes the highlight bar to move down.
- Turning the knob counterclockwise causes the highlight bar to move up.

You can change the default setting for the general purpose knob by following the steps below:

1. Push the **UTILITY** (front-panel)→**System** (bottom).
2. Select **Knob Direction** by using the ▲ and ▼ buttons.
3. Select **Forward** or **Backward** using the general purpose knob.

The changes take affect immediately.

Formatting a Floppy Disk

The AWG710&AWG710B Arbitrary Waveform Generator provides the function to format a 2HD 1.44 MB floppy disk into Windows 9x compatible format (FAT16/VFAT compatible). Note that you cannot define a disk label for the floppy disk.

NOTE. *Formatting a floppy disk destroys any data on that disk. Before formatting a disk, make sure it does not contain needed data.*

Do the following steps to format a floppy disk:

1. Insert a floppy disk into the floppy disk drive.
2. Push the **UTILITY** (front-panel)→**Disk** (bottom).
3. Push the **Quick Format** side button to begin formatting.

While the formatting is being executed, the clock icon is displayed in the screen. When formatting is complete, the clock icon disappears and the floppy disk drive LED goes off.

Displaying Disk Usage

The AWG710&AWG710B Arbitrary Waveform Generator displays the information regarding the disk usage and free space on the hard disk and floppy disk.

1. Push the **UTILITY** (front-panel)→**Disk** (bottom).
2. Push the **Main** side button for the hard disk or **Floppy** side button for the floppy disk.

The drive name, free space, and total capacity for the selected storage drive is displayed.

Free space for the currently selected storage drive is displayed in the file list on the EDIT menu screen.

NOTE. *The internal disk free space that the user can use is restricted to 90% of the disk space. You can transfer files over the limitation using ftp, however, keep this restriction to maintain the instrument performance.*

Screen Display Enable/Disable

In some instances, such as having the AWG710&AWG710B installed in a rack mount, you may not want to have the LCD back light turned on.

Do the following steps to turn off the LCD Back Light:

1. Push **UTILITY** (front-panel)→**System** (bottom)→**LCD Back Light** (screen)
2. Turn the general purpose knob or ◀ ▶ buttons to enable or disable the Screen Display.

Push **CLEAR MENU** (front-panel) twice to turn on the LCD Back Light.

Focused Color

Do the following steps to adjust the Hilight Color:

1. Push **UTILITY** (front-panel)→**System** (bottom).
2. Select **Hilight Color:** using the ▲ and ▼ buttons.
3. Turn the general purpose knob clockwise or counterclockwise until you get the color you want.

The changes take effect immediately. You can display the system utility screen and set the highlight color at any time without exiting current tasks.

Displaying Instrument Status

Do the following steps to display the instrument software version and status of the SCPI registers.

1. Push **UTILITY** (front-panel)→**Status** (bottom)→**System** (side) to display the instrument software version.
2. Push **UTILITY** (front-panel)→**Status** (bottom)→**SCPI Registers** (side) to display the current status of the SCPI registers.

Refer to the AWG710&AWG710B *Arbitrary Waveform Generator Programmer Manual* for the SCPI registers.

Internal Clock (Date and Time)

Do the following steps to set the date and time in the AWG710&AWG710B Arbitrary Waveform Generator:

1. Push **UTILITY** (front-panel)→**System** (bottom).
2. Set the current year, month and day in the **Year**, **Month** and **Day** fields.
3. Set the current hour, minutes and seconds in the **Hour**, **Min** and **Sec** fields.

The changes are effective immediately.

Resetting the Instrument

The AWG710&AWG710B Arbitrary Waveform Generator uses the Factory Reset and Secure commands to reset the instrument.

Factory Reset **Factory Reset** resets the instrument to the factory settings at the time of shipment. Some settings that are set in the UTILITY menu such as Network and GPIB settings, are not reset when **Factory Reset** is initiated.

To perform the factory reset, do the following steps:

1. Push **UTILITY** (front-panel)→**System** (bottom)→**Factory Reset** (side)→**OK** (side).

NOTE. Before pushing the OK side button, confirm that the data in the editor has been saved to a file.

Secure Secure is a function that removes the settings and all data files stored in the instrument hard disk. This is sometimes useful when you are storing data that is confidential and when you must transport the instrument for servicing or demonstrations.



CAUTION. Executing Secure removes all settings and data files in the hard disk. Make sure you want to remove all data before execution. You cannot recover the removed files.

Do the following steps to execute the Secure function:

1. Push **UTILITY** (front-panel)→**System** (bottom)→**Secure** (side).

The following message is displayed in the message box:

Secure destroys settings, and ALL DATA FILES

2. Make sure that you want to remove all the settings and data.
3. Push the **OK** side button.

All files, including the files used in the AWG710&AWG710B Arbitrary Waveform Generator system, are removed, and the instrument settings are replaced with the factory settings.

Connecting to a GPIB Network

The GPIB Interface can be used for remotely controlling the instrument from an external device (such as a PC) and for capturing waveform data from an external device (such as a Tektronix TDS-Series oscilloscope). This section describes how to set up the instrument GPIB interface.

Refer to the AWG710&AWG710B *Programmer Manual* for information regarding remote control commands. Refer to *Capturing Waveforms* on page 3-181 for procedures and information regarding how to transfer waveforms from an external device.

Setting GPIB Parameters

Configuration and Address are two GPIB parameters that you must set. The GPIB Configuration contains three parameters:

- **Talk/Listen:** Select this mode to remotely control the AWG710&AWG710B Arbitrary Waveform Generator from an external host computer.
- **Controller:** Select this mode to use the AWG710&AWG710B Arbitrary Waveform Generator as a controller to transfer waveform data to or from another device connected to the GPIB bus.
- **Off Bus:** Select this mode to electronically disconnect the AWG710&AWG710B Arbitrary Waveform Generator from the GPIB bus.

The GPIB address defines a unique address for the AWG710&AWG710B Arbitrary Waveform Generator. Each device connected to the GPIB bus must have a unique GPIB address. The GPIB address must be from 0 to 30.

Do the following steps to set the GPIB parameters:

1. Select **UTILITY** (front-panel)→**Comm** (bottom). The screen as shown in Figure 3-51 appears.

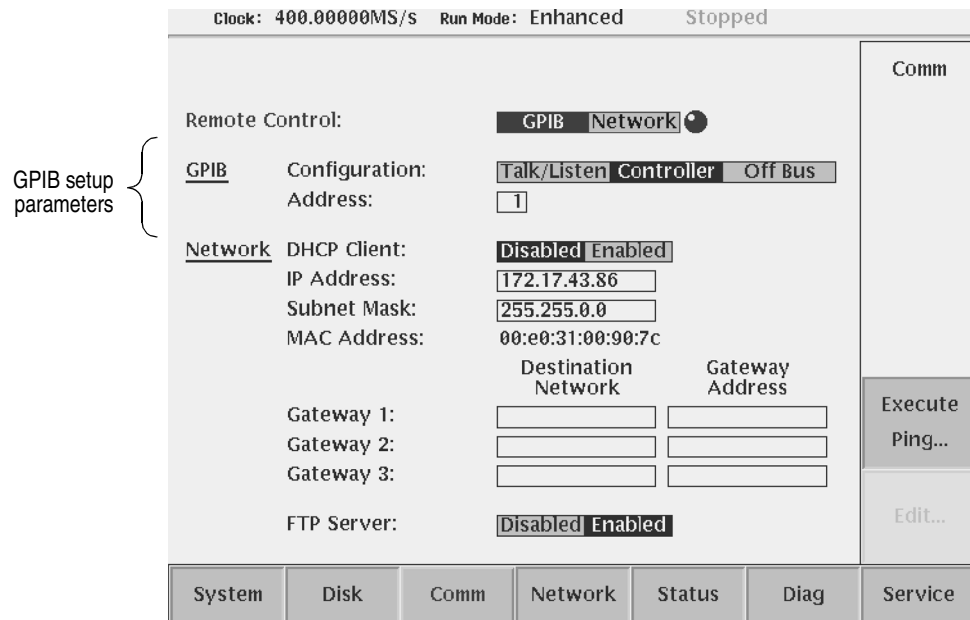

Figure 3-51: GPIB setup screen menu

2. Select **GPIB** for remote control.
 - a. Select Remote control using ▲ and ▼ buttons.
 - b. Select **GPIB**.
3. Set the GPIB bus connection parameter:
 - a. Select the GPIB Configuration using ▲ and ▼ buttons.
 - b. Select a configuration mode: **Talk/Listen**, **Controller**, or **Off Bus**.
4. Set the instrument GPIB address:
 - a. Select the GPIB Address using ▲ and ▼ buttons.
 - b. Set the GPIB address using the general purpose knob.
Make sure that the value you enter is unique for this GPIB bus.

The changes take effect immediately.

Ethernet Networking

The AWG710&AWG710B Arbitrary Waveform Generator can be connected to a network to access hard disk file systems in the remote computers that use Network File System (NFS) protocol. You can also log into the AWG710&AWG710B Arbitrary Waveform Generator from the remote computer to transfer files by using FTP link software.

You can set up to three remote computers with the AWG710&AWG710B Arbitrary Waveform Generator and mount their file systems at the same time. You select the remote files the same way that you select the internal hard disk or floppy disk.

This subsection describes the following network operations:

- Connecting to Ethernet
- Testing the network connection
- Network Parameter
- Mounting remote file systems
- Setting a FTP link

Refer to the AWG710&AWG710B *Programmer Manual* for more information on Ethernet networking.

Connecting to the Ethernet

You can connect the AWG710&AWG710B Arbitrary Waveform Generator to a 100/10 BASE-T Ethernet network. To mount a remote file system or to control the instrument from an external computer, you must set the following parameters in the instrument:

- IP address and Subnet Mask for the AWG710&AWG710B Arbitrary Waveform Generator

or

Automatically obtains IP address and other parameters with DHCP (Dynamic Host Configuration Protocol) client function.

- Up to three gateway addresses (if necessary)

Figure 3-52 shows the setup screen menu that you can use to set the network parameters to your AWG710&AWG710B Arbitrary Waveform Generator.

NOTE. *To connect the instrument to the Ethernet, you need to connect the cables before you power on the instrument.*

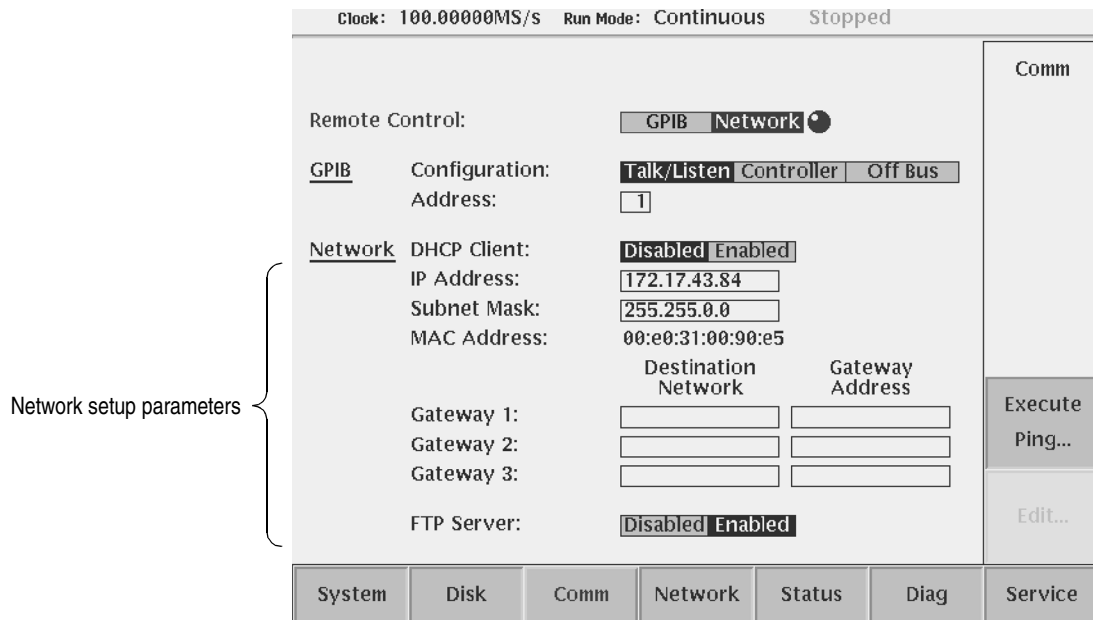

Figure 3-52: Network setup screen menu

To let the network recognize the AWG710&AWG710B Arbitrary Waveform Generator, set the IP address and Subnet Mask. If necessary, also set the Gateway address by the steps below:

1. Push **UTILITY** (front-panel)→**Comm** (bottom) to display the network setup screen menu.
2. Do the following steps to control the instrument through Ethernet.
 - a. Select **Remote Control** using **▲** and **▼** buttons.
 - b. Select **Network**.
3. Set an IP address of your AWG710&AWG710B Arbitrary Waveform Generator in the IP Address field. To set the IP address, there are two methods:
 - Set the parameters manually:
 - a. Move the cursor to **DHCP client** field using **▲** and **▼** buttons, and select **Disabled** using the general purpose knob or **◀ ▶** buttons.
 - b. Move the cursor to **IP Address** field using **▲** and **▼** buttons, and push **Edit...** side button.
 - c. Set the IP address in the IP Address setup dialog box.
 - d. If necessary, set a subnet mask in the Subnet Mask field.

- Obtain an IP address automatically:
 - e. Move the cursor to **DHCP client** field using ▲ and ▼ buttons, and select **Enabled** using the general purpose knob or ◀ ▶ buttons.
 - f. AWG710&AWG710B Arbitrary Waveform Generator automatically sends a request for obtaining the address to DHCP server. The server sends back the address to the instrument. The address is displayed in the IP Address field.
- 4. If necessary, set a gateway address and destination network in the **Gateway Address** and **Destination Network** fields.

Set the Gateway address of a gateway when the remote computers are connecting to another network that is connected to the network through a gateway. You can set up to three gateways.
- 5. Set the FTP server to Disable or Enable in the FTP Server field.

Setting the FTP server to Enable allows you to enter into the hard disk system of the instrument from a remote computer.

The changes take effect immediately. If you are not familiar with the network setup, consult with your network administrator.

NOTE. The port number is fixed to 4000. This port number must be assigned to the application software or the Ethernet driver on the external controller. The port number 4002 is used for communication between master and slave on the Synchronous operation mode. (only AWG710B)
The MAC Address is displayed on the network setup screen menu.

Testing the Network Connection

Complete the physical connection and settings. Verify that the AWG710&AWG710B Arbitrary Waveform Generator can recognize the network and the remote computers, and whether the network can recognize the AWG710&AWG710B Arbitrary Waveform Generator.

Do the following steps to use the ping command to verify that the instrument can communicate with the network:

1. Push **UTILITY** (front-panel)→**Network** (bottom) or **UTILITY** (front-panel)→**Comm** (bottom).
2. Push the **Execute Ping** side button to display a dialog box.
3. Enter the IP address of the remote computer in the dialog box.
4. Push the **OK** side button.

The ping command sends a packet to the remote computer specified by the IP address. When the computer receives the packet, it sends the packet back to the sender (your AWG710&AWG710B Arbitrary Waveform Generator).

When the AWG710&AWG710B Arbitrary Waveform Generator can communicate with the remote computer through the network, the message as shown in Figure 3-53 is displayed. If it failed to establish the communication, the message box displaying an error message such as *No answer xx.xx.xx.xx* is displayed.

5. Repeat steps 2 and 3 for all the remote computers to which you desire to verify the connection through the network.

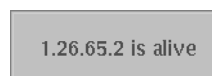

Figure 3-53: Message box to indicate the establishment of communication

Network Parameter

Select either **Comm** bottom button to display Communication screen or **Status** (bottom) → **Network** (side) buttons to display Status screen that show setting parameters for the network.

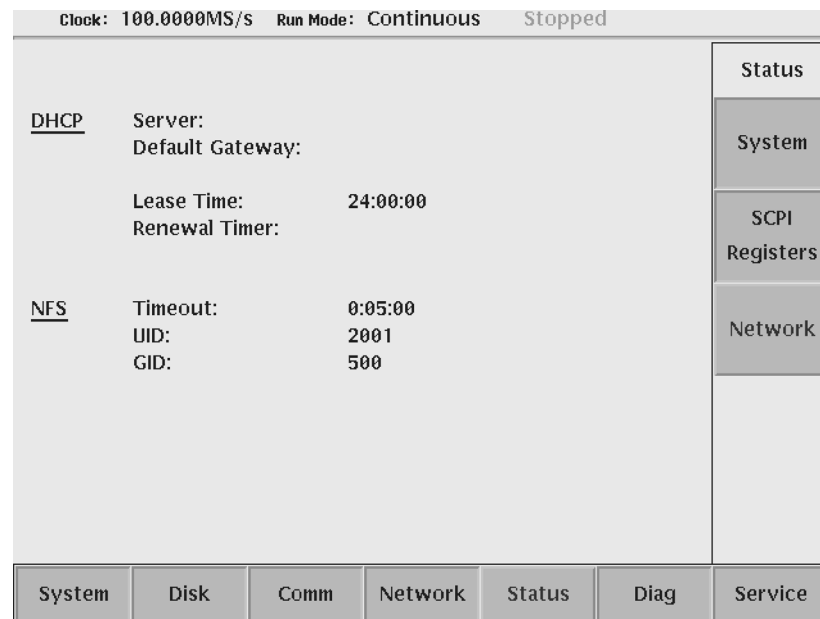

Figure 3-54: Network Status screen

Optional Parameters

You can set the DHCP Lease Time, NFS Timeout and FTP server version. Do the following steps to set these parameters.

1. Push **UTILITY** (front-panel)→**Service** (bottom)→**Tweak AWG1** (pop-up)→**OK** (side).
2. Push **DHCP Lease Time** (side) and set the DHCP Lease time using the general purpose knob or the numeric keypads. The time range is from 30 to 86400 seconds (24 hours).
3. Push **NFS Timeout** (side) and set the NFS Timeout using the general purpose knob or the numeric keypads. The time range is from 25 to 300 seconds.
4. Push **FTP Version** (side) button to toggle between **Standard** and **Obsolete**. Usually, select Standard.

Mounting Remote File Systems

Figure 3-55 shows the screen menu in which you can set the parameters to mount a remote file system on the AWG710&AWG710B Arbitrary Waveform Generator, using the NFS protocol. Refer to the documentation about the NFS, for the details on the remote file system, the NFS protocol and/or how to set the NFS in the computers.

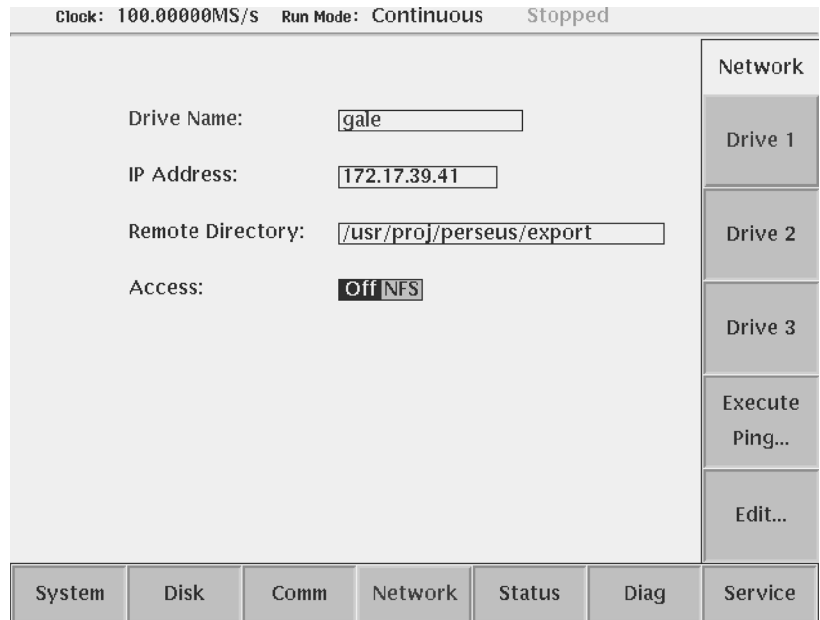

Figure 3-55: UTILITY screen mounting remote file system

Do the following steps to mount the remote file system:

1. Push **UTILITY** (front-panel)→**Network** (bottom).

2. Push the **Drive1** side button for setting a remote file system as a drive 1.
Do the following substeps to set the remote file system for the Drive 1:

NOTE. *You cannot select the Access field unless you set an IP address and remote directory.*

- a. Select the Drive Name: field using ▲ and ▼ buttons.
- b. Push the **Edit...** side button.
The Drive Name dialog is displayed.
- c. Input a drive name using the Key pad and the General Purpose knob.
(Push the Shift key to change the characters in the dialog box to upper case.)
- d. Push the **OK** side button to enter the drive name.
The drive name set here is displayed as one of the drive selections. Figure 3-56 shows an example of the drive selections. In this case, the drive name of Drive 1 is changed with NET1 to UNIX02.

Set the remote computers IP address in the IP Address field:

- e. Select the IP Address: field using ▲ and ▼ buttons.
- f. Push the **Edit...** side button.
Network Drive Address dialog is displayed.
- g. Input a IP Address using the Key pad and the General Purpose knob.
- h. Push the **OK** side button to enter the IP Address.

Set the remote computers directory in the Remote Directory field:

- i. Select the Remote Directory: field using ▲ and ▼ buttons.
- j. Push the **Edit...** side button.
Network Drive Directory dialog is displayed.
- k. Input a remote computers directory name using the Key pad and the General Purpose knob. (A push on the Shift key changes characters in the dialog box to a capital letter.)
- l. Push the **OK** side button to enter the remote computers directory name.

Specify a remote file system node in the Remote Directory field:

- m. Select the Access: field using ▲ and ▼ buttons.
- n. Select Off or NFS using ⏏, ⏏, or the General Purpose knob.

You can connect or disconnect to/from the network logically while connecting physically. Select Off to disconnect, and NFS to connect.

You can use all the file system existing under the node you specified here through the AWG710&AWG710B Arbitrary Waveform Generator.

3. Repeat substeps a through n to set the remote file systems for Drive 2 and Drive 3, if necessary.

The changes take effect immediately. You can use the remote file system defined in above procedures by selecting a storage media.

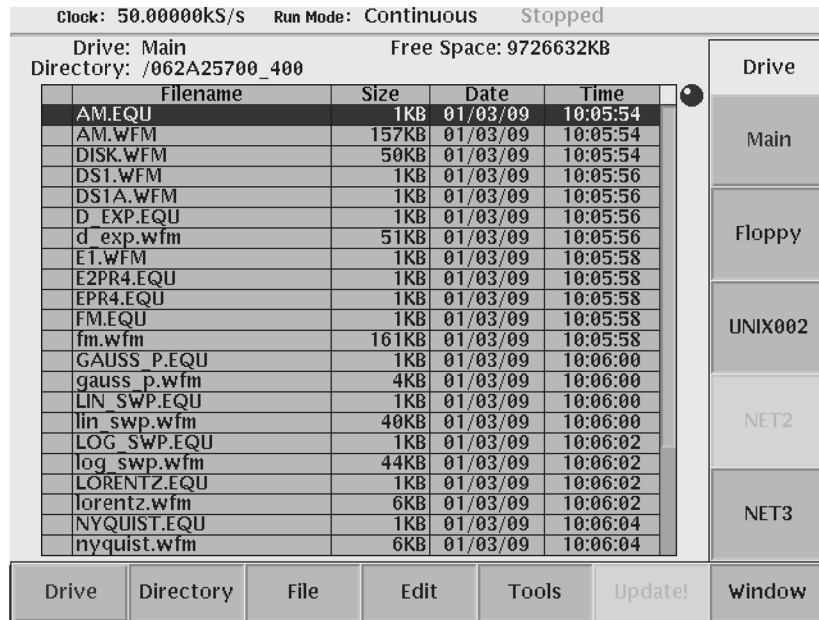

Figure 3-56: Drive selections in EDIT menu

FTP Link Set the FTP Server to enable you to enter into the hard disk or floppy disk file system of the AWG710&AWG710B Arbitrary Waveform Generator from a remote computer.

Type the following command on your computer keyboard:

```
ftp <IP address>
```

Press Return on the keyboard.

The AWG710&AWG710B Arbitrary Waveform Generator prompts you to enter a login name and password. Press the Return or Enter key on your keyboard. The message

```
'User log in'
```

and the prompt

```
'ftp>'
```

appears when you are successfully logged in.

At the prompt, you can use the commands as listed in Table 3-44. These are the only available FTP (File Transfer Protocol) commands for use with the instrument.

Table 3-44: Available FTP commands

Commands	Descriptions
ascii	Sets the file transfer mode to ascii.
binary	Sets the file transfer mode to binary. Use this mode when you transfer a file other than the text file.
bye	Terminate the ftp session and exit the ftp.
cd xxxx	Changes the current working directory on the instrument. Specify a directory at xxxx. To change the drive, specify “/drive-name”. For example, to move into the floppy disk, type the following: cd “/floppy” Type “/main” for the hard disk drive and “/NET1/” for remote file system NET1, and so on.
dir	Lists all the files in the current directory in the instrument.
get xxxx [local-file]	Receives the file xxxx in the instrument and stores it in the local file. The xxxx name is used if the local file is not specified
hash	Toggles the hash-sign on and off. The hash-sign is printed for each data block transferred when the hash-sign (#) is set to on.

Table 3-44: Available FTP commands (cont.)

Commands	Descriptions
ls	Lists the all files in the current working directory in the instrument.
put <i>xxxx</i> [<i>remote-file</i>]	Transfers the file <i>xxxx</i> in your local computer and stores it in the instrument file. The same <i>xxxx</i> name is used for a instrument file if the remote file is not specified.
pwd	Print the path to the current directory in the instrument
quit	Terminates the ftp session and exits the ftp.

NOTE. *The ftp server in the AWG710&AWG710B Arbitrary Waveform Generator does not support mget commands, or meta characters. For example, when you use the put command with meta character as follows:*

```
put ABS.WFM *.*
```

*a file named *.* may be created in the internal disk of the AWG710&AWG710B Arbitrary Waveform Generator.*

*This *.* file is not displayed on the AWG710&AWG710B Arbitrary Waveform Generator file list. Access to a file created in this manner is not possible through the front panel. Use GPIB commands to access such files.*

In some FTP client software, you many not be able to use these commands.

Hardcopy

The image on the screen can be output to a file. Use a hardcopy file to make reports with a desktop publishing (DTP) application software running on PC, or output those files to a printer using a PC. You cannot connect a printer directly to the instrument.

Initiate hardcopy function by pushing the **HARDCOPY** button on the front-panel or entering the GPIB command. You can select either BMP, TIFF, BMP COLOR or TIFF COLOR for the file formats. Select the hard disk, floppy disk, or a remote computer file system for the file output destination. The file size is approximately 150 Kbytes for TIFF format and 300 Kbytes for other formats.

Hardcopy Settings

Specify the hardcopy format and the output destination you needed before running a hardcopy.

1. Push **UTILITY** (front-panel)→**System** (bottom) to display the hardcopy setup screen. See Figure 3-57.

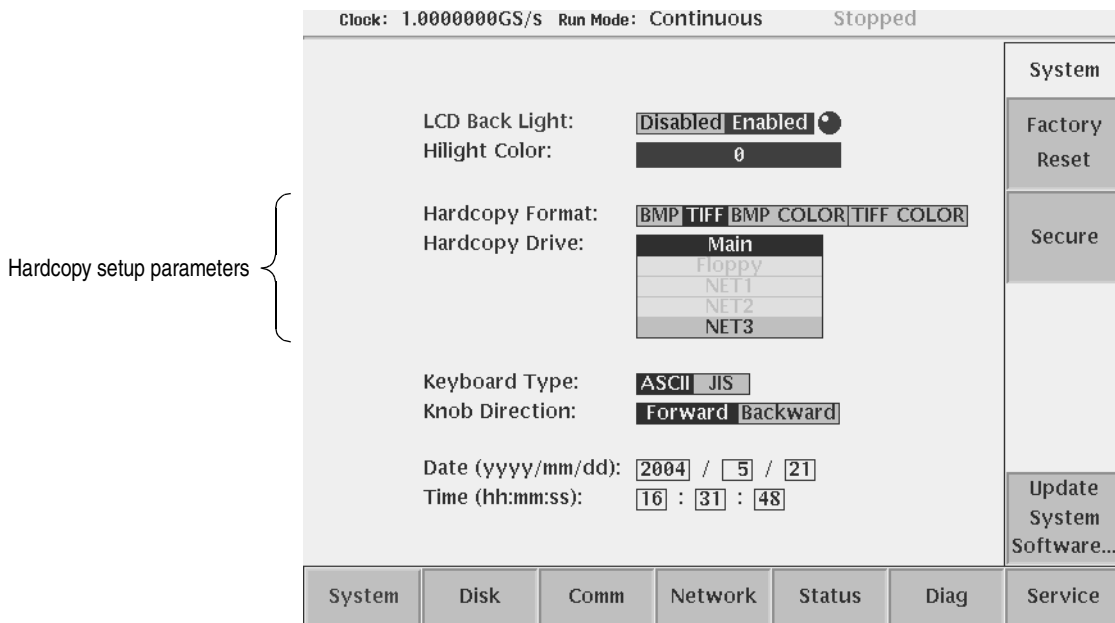

Figure 3-57: Hardcopy setup screen

2. Select **Hard Copy Format** using the ▲ or ▼ button.
3. Select either **BMP**, **TIFF**, **BMP COLOR**, or **TIFF COLOR** using the general purpose knob or the ◀ or ▶ button.
4. Select the **Hard Copy Drive** where the files are stored using the ▲ or ▼ button.
5. Select **Main**, **Floppy**, or **NETx** using the general purpose knob.

The **NETx** refers to the remote computer file system that you defined. By default, they are **NET1**, **NET2** and **NET3**. For defining the remote file system, refer to page 3-166.

Running Hardcopy

When you push the **HARDCOPY** button on the front panel, the currently displayed image on the screen is output to an image file. The file format and output destination drive are as specified in the **UTILITY** menu. The destination directory is the current one.

Follow the steps below to make a hardcopy.

1. Display the view on the screen that you want hardcopied.
2. Push the **HARDCOPY** button on the front panel.

A message box displaying the output destination and file name appear when the hardcopy function terminates. See Figure 3-58.



Figure 3-58: Hardcopy complete message box

3. Push the **OK** side button.

Use the EDIT menu to rename a created file or move it to another directory.

Saving Hardcopy to a File

If you use the **HARDCOPY** button to produce a hardcopy file, a file name such as *TEK00000.BMP* is automatically assigned as the file name. The “TEK” substring is fixed. The “00000” substring indicates the counter value, which is reset to 0 each time you power on the instrument. Hereafter, it is incremented by 1 each time a hardcopy is produced. The extension is either ‘BMP’, ‘TIF’, ‘BMP COLOR’, or ‘TIF COLOR’, depending on the specified format. The output destination drive will be as specified in the UTILITY menu. The drive and path are the current drive and directory of the GPIB that are set when the **Hardcopy** command is received from the GPIB.

If you use the GPIB command to produce a hardcopy, you must specify the output filename using the filename only. Refer to the *AWG710&AWG710B Arbitrary Waveform Generator Programmer Manual* for more details.

Calibration and Diagnostics

The AWG710&AWG710B Arbitrary Waveform Generator can perform calibration and tests on the internal hardware. This function requires minimal time to perform, requires no additional equipment, and tests the internal hardware of the instrument. These tests can be used to quickly determine if the instrument is suitable for service.

The calibration and diagnostics can be performed in the screen that appears when you push **UTILITY** (front-panel)→**Diag** (bottom).

Calibration

The calibration updates the internal constants so that the instrument outputs waveforms within the specified accuracy. See Figure 3-60 for the calibration items and possible error codes.

The calibration must be performed in the following cases:

- After a 20-minute warm up period
- Prior to high precision waveform output
- When the ambient temperature has changed more than +5 °C or less than -5 °C from the previous calibration

Refer to the calibration and diagnostic screen to see if calibration has recently been performed on the instrument. See Figure 3-60.

The calibration has completed when Done is displayed in the Calibration result field. No calibration has been performed if the --- is displayed. The factory reset also causes the --- to be displayed.

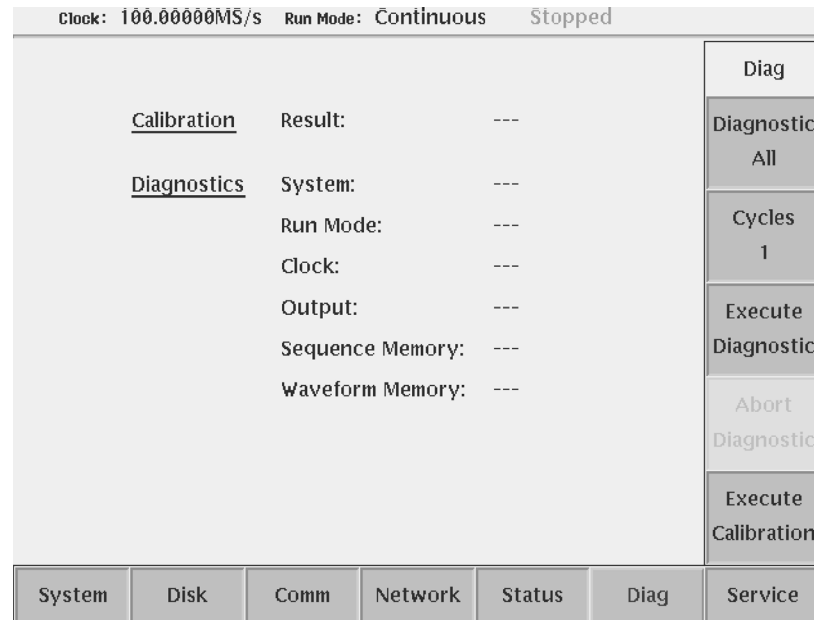

Figure 3-59: Calibration and diagnostic screen

NOTE. The calibration data in the memory may be lost if the instrument is powered off while the calibrations are running.

Do the following steps to execute the calibration:

1. Push the **RUN** button to turn the output off if a waveform is being output.
The RUN LED is off.
2. Push **UTILITY** (front-panel)→**Diag** (bottom)→**Execute Calibration** (side).
The internal calibration routine runs immediately and requires up to 15 seconds to complete.

The status message box appears when calibration has been terminated. See Figure 3-60.

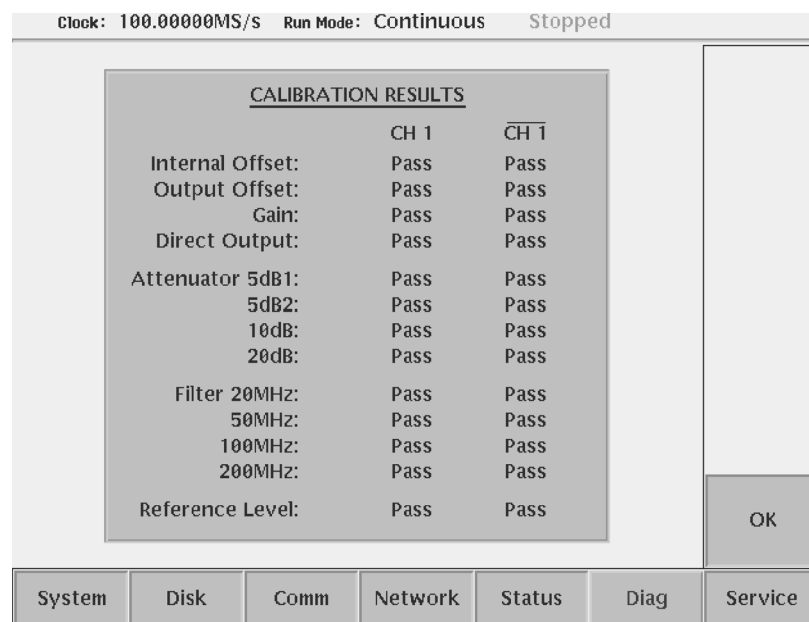

Figure 3-60: Status message box (except option02)

Pass is displayed in the message box if the calibration successfully terminates. **Fail** is displayed if calibration encounters a problem.

Push the **OK** side button or **CLEAR MENU** button to erase the status message box and return to the screen shown in Figure 3-59.

Power-on Diagnostics

At power on, a limited set of hardware tests for all the test categories are performed and the results are displayed on the screen. The instrument displays the following message when an error is detected:

Press any key to go to the **SETUP** menu screen.

An error in the digital to analog converter (DAC) may be reported if you do not execute the system calibration at power-on.

See Table 3-45 for the test categories and error codes.

Manual Diagnostics

The manual diagnostics routines can execute a full set of hardware tests for all the test categories or only for the specified category except for the DAC. You can also specify a test cycle of 1 to infinite times.

NOTE. When you execute the Waveform memory self test, it takes 1.5 minutes for standard type, 3 minutes for option 01.

Do the following steps to execute the diagnostics:

1. Push the **RUN** button to turn the output off if a waveform is being output.
The RUN LED turns off.
2. Push **UTILITY** (front-panel)→**Diag** (bottom).
The screen shown in Figure 3-59 appears.
3. Push the **Diagnostic xxxx** side button and select a test category by using the general purpose knob.
The xxxx represents currently selected test category. You can select a test category from All, System, Run Mode, Clock, Output, Seq Mem and Wave Mem. If you select All, the diagnostic routines of all categories are executed.
4. Push the **Cycle n** side button and select a test cycle by using the general purpose knob.
The n represents a currently selected test cycle. You can select a test cycle from 1, 3, 10, 100 or Infinite. If you select Infinite, the diagnostic tests are repeated infinitely. Push the **Abort Diagnostic** side button to stop the execution.
5. Push the **Execute Diagnostic** side button to start the diagnostic tests.

The --- is displayed at each test category on the screen either at the beginning or after the factory reset. The mark --- is also displayed while the diagnostic test is executing. See Figure 3-60. When the diagnostic test terminates without error, Pass is displayed instead of the ---. The test routine displays the error code and skips to the next test if an error is detected.

See Table 3-45 for the test categories and error codes.

Table 3-45: Diagnostic categories and error codes

Categories	Error codes	Descriptions
Calibration	1101 to 1104	Internal offset calibration error
	1201 to 1204	Output offset calibration error
	1301 to 1304	Gain calibration error
	1401 to 1404	Gain difference calibration error
	1501 to 1504	Direct out calibration error
	1601 to 1604	Attenuator calibration error
	1611 to 1614	5dB attenuator 1 calibration error
	1621 to 1624	5dB attenuator 2 calibration error
	1631 to 1634	10dB attenuator calibration error
	1641 to 1644	20dB attenuator calibration error
	1701 to 1704	Filter calibration error
	1711 to 1714	20MHz filter calibration error
	1721 to 1724	50MHz filter calibration error
	1731 to 1734	100MHz filter calibration error
	1741 to 1744	200MHz filter calibration error
1801 to 1804	Reference level error	
System	2100	System test error
	2101	Real-time clock power test error
	2102	Configuration record, checksum status error
	2103	Incorrect configuration
	2104	Memory size test error
	2105	Fixed-disk drive initialization status error
	2106	Time status error
	2110 to 2116	Front-panel test error
2700 to 2703	Calibration data test error	
Run mode	3000	Run mode test error
	3100	Run mode control register 0 test error
	3101 to 3108	Run mode control register test error (reg0 to reg7)
	3200	Run mode control register 1 test error
	3201	Run mode control register 1 reg0
	3211	Run mode control register 1 reg10
Clock	4000	Clock test error
	4100	PLL lock/unlock test error

Table 3-45: Diagnostic categories and error codes (cont.)

Categories	Error codes	Descriptions
Sequence memory	5000	Sequence memory test error
	5100	Data bus test error
	5101 to 5132	Data bus test error (bit 0 to bit 31)
	5200	Address bus test error
	5201 to 5216	Address bus test error (bit 0 to bit 15)
	5300	Chip cell test error
	5301 to 5302	Chip cell test error (chip 0 to chip 1)
	5350	Chip select test error
	5351 to 5352	Chip select test error (chip select 0 to chip select 1)
Waveform memory CH1	6000	Waveform memory test error
	6100	Data bus test error
	6101 to 6132	Data bus test error (bit 0 to bit 31)
	6150	Chip data bus test error
	6151 to 6186	Chip data bus test error (chip 0 to chip 31)
	6200	Address bus test error
	6201 to 6219	Address bus test error (bit 0 to bit 18)
	6300	Chip cell test error
	6301 to 6336	Chip cell test error (chip 0 to chip 35)
	6350	Chip select test error
	6351 to 6386	Chip select test error (chip select 0 to chip select 35)
	Output	7000
7100		Internal offset device test error
7101 to 7104		Internal offset device test error (CH1 to $\overline{\text{CH1}}$)
7200		Output offset device test error
7201 to 7204		Output offset device test error (CH1 to $\overline{\text{CH1}}$)
7300		ARB gain test error
7301 to 7304		ARB gain test error (CH1 to $\overline{\text{CH1}}$)
7400		Direct gain test error
7401 to 7404		Direct gain test error (CH1 to $\overline{\text{CH1}}$)
7510		5dB attenuator 1 test error

Table 3-45: Diagnostic categories and error codes (cont.)

Categories	Error codes	Descriptions
	7511 to 7514	5dB attenuator 1 test error (CH1 to $\overline{\text{CH1}}$)
	7520	5dB attenuator 2 test error
	7521 to 7524	5dB attenuator 2 test error (CH1 to $\overline{\text{CH1}}$)
	7530	10dB attenuator test error
	7531 to 7534	10dB attenuator test error (CH1 to $\overline{\text{CH1}}$)
	7540	20dB attenuator test error
	7541 to 7544	20dB attenuator test error (CH1 to $\overline{\text{CH1}}$)
	7610	20 MHz filter test error
	7611 to 7614	20 MHz filter test error (CH1 to CH1)
	7620	50 MHz filter test error
	7621 to 7624	50 MHz filter test error (CH1 to $\overline{\text{CH1}}$)
	7630	100 MHz filter test error
	7631 to 7634	100 MHz filter test error (CH1 to $\overline{\text{CH1}}$)
	7640	200 MHz filter test error
	7641 to 7644	200 MHz filter test error (CH1 to $\overline{\text{CH1}}$)
	7700 to 7704	Reference level test error
Waveform/Sequence	9111	Load error, memory full
	9112	Load error, invalid waveform length
	9113	Load error, waveform length too short
	9114	Load error, waveform length changed
	7700 to 7704	Reference level test error
Sequence	9121	Load error, missing file name in sequence
	9122	Load error, too many nesting levels
	9123	Load error, infinite loop in sub-sequence
	9124	Load error, infinite sub-sequence level
	9125	Load error, max sequence elements exceeded
	9126	Load error, invalid jump address
	9127	Load error, sequence memory full
	9128	Load error, infinite loop and Goto One not allowed
	9129	Load error, infinite loop and Goto <N> not allowed
Waveform	9151	Load warning, output disabled in some channels
Waveform/Sequence	9152	Output warning, output disabled

Upgrading the System Software

The system software in the AWG710&AWG710B Arbitrary Waveform Generator can be updated by using the utility menu. The System software consists of both the user program and the operating system. The upgrades can be done independent of each other. Refer to page 3-158 for information regarding the current system software versions.

Preparation Do the following prior to performing the system software upgrade procedure:

- Read the Instruction documents included in the upgrade kit carefully.
- Refer to the instruction documents included in the upgrade kit for more information.



CAUTION. To avoid damage to the instrument, follow the instruction documentation included in the upgrade kit.

Upgrade Procedure Follow the steps below to upgrade system software:

1. Copy the system software in the upgrade kit to the AWG710&AWG710B Arbitrary Waveform Generator internal disk.
2. Push **UTILITY** (front-panel) → **System** (bottom) → **Update System Software...** (side) → **Update Program...** or **Update OS...** (side).
3. Before executing the update, a caution dialog appears. Push the **OK** (side) button to continue, or the **Cancel** (side) button to abort.

The Select File dialog box appears.

4. Select the file for upgrade that was copied in step 1, then press the **OK** (side) button.

The file confirmation dialog box appears.

5. Press the **OK** (side) button.

The AWG710&AWG710B Arbitrary Waveform Generator checks the selected file properties. The “Illegal file format” message appears if you select an invalid file. The AWG710&AWG710B Arbitrary Waveform Generator updates the system software.

6. After the updating procedure has completed, power off, then power on the instrument. The AWG710&AWG710B Arbitrary Waveform Generator starts up with updated system software.

Capturing Waveforms

This section explains how to transfer waveforms from the instruments to the AWG710&AWG710B Arbitrary Waveform Generator using the GPIB interfaces.

The AWG710&AWG710B Arbitrary Waveform Generator captures the waveform data acquired in oscilloscopes and/or generated in generators over the GPIB interface without control by an external controller. The waveforms captured are automatically converted to waveforms that the AWG710&AWG710B Arbitrary Waveform Generator can handle.

When you use this function, set the AWG710&AWG710B Arbitrary Waveform Generator GPIB configuration to controller.

Possible Instruments

The Waveform Generator captures waveforms from following instruments:

- Tektronix TDS–Series oscilloscopes
- LeCroy digital oscilloscopes

Basic Concept on Communication for Capturing

Waveform data is transferred over the GPIB network. The AWG710&AWG710B Arbitrary Waveform Generator must be the controller and the other instrument(s) must be in the Talk/Listen mode. All instruments including the AWG710&AWG710B Arbitrary Waveform Generator must have a unique GPIB address.

When you execute this function, the AWG710&AWG710B Arbitrary Waveform Generator starts addressing the instruments that are connecting to the same GPIB network from the lower to the higher GPIB address. When an addressed instrument responds, the AWG710&AWG710B Arbitrary Waveform Generator stops addressing and starts the negotiation for waveform data transfer.

The AWG710&AWG710B Arbitrary Waveform Generator communicates with the first instrument that responds (possibly the one that has the lowest GPIB address in the same network) and the type that you specified.

You must set the GPIB address and Talk/Listen mode, but you do not need the other settings in the source instrument. The AWG710&AWG710B Arbitrary Waveform Generator performs all settings to the source instrument necessary for waveform transfer during negotiation.

Procedures for Capturing Waveforms

Do the following steps to capture a waveform:

1. Set the GPIB parameters in the AWG710&AWG710B Arbitrary Waveform Generator.

The AWG710&AWG710B Arbitrary Waveform Generator must be set to the controller. Refer to *Connecting to a GPIB Network* on page 3-160 for setting the GPIB parameters.

2. Push **UTILITY** (front-panel)→**Comm** (bottom)
3. Select Remote control field using ▲ and ▼ buttons. Select **GPIB**.
4. Select the GPIB Configuration field using ▲ and ▼ buttons. Select **Controller**.
5. Set the AWG710&AWG710B GPIB address.
6. Push **EDIT** (front-panel)→**Tools** (bottom)→**Capture Waveform** (side).

The dialog box listing the instruments appears as shown in Figure 3-61.

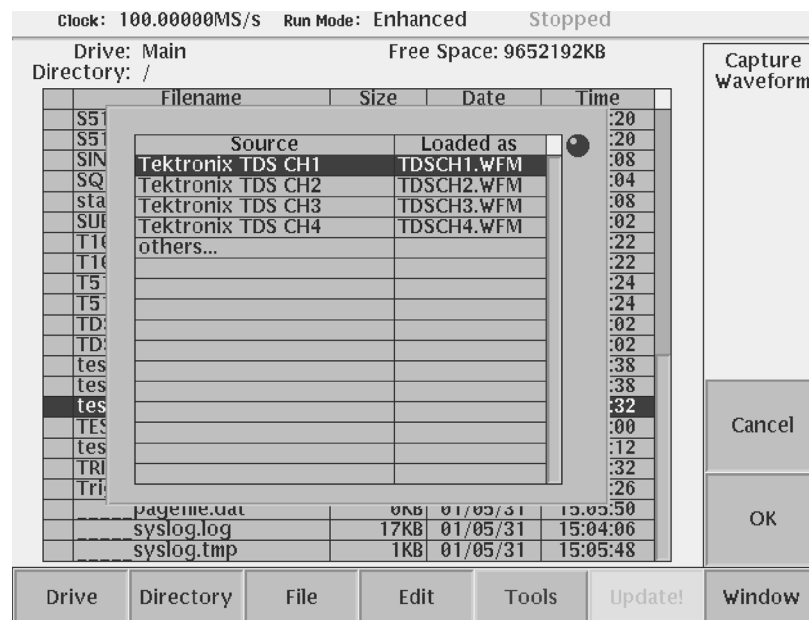

Figure 3-61: Source instrument selection dialog box

- a. If necessary, select **Others...** to open the other source instrument list.

The dialog box listing the instruments appears as shown in Figure 3-62.

- b. Select a source instrument from the list.
- c. Push the **OK** side button.

The AWG710&AWG710B Arbitrary Waveform Generator starts transferring the waveform from the selected source instrument. The file transferred to the AWG710&AWG710B Arbitrary Waveform Generator is automatically converted and saved in the file specified in the column of the line you selected. If needed, change the file name and perform another waveform data transfer.

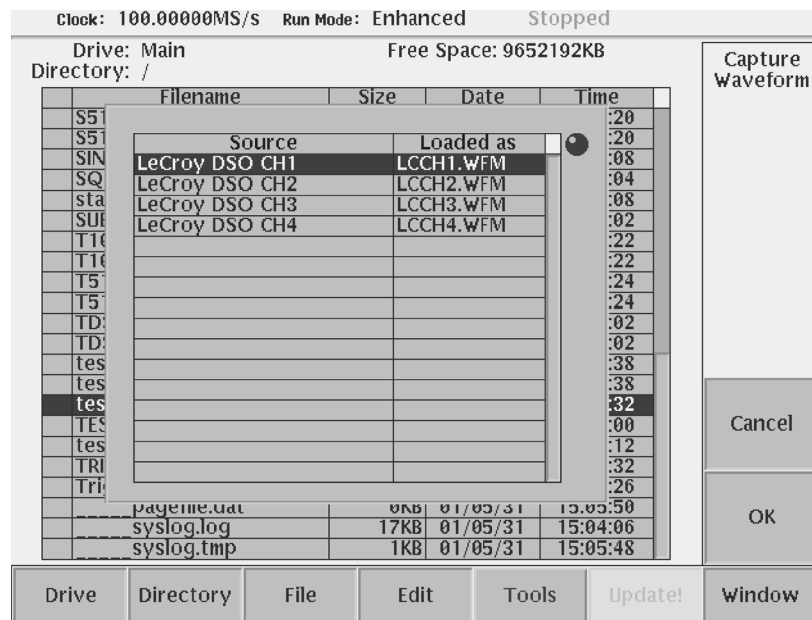

Figure 3-62: Source instrument selection under Others...

NOTE. The AWG710&AWG710B Arbitrary Waveform Generator is unable to transfer waveforms during some oscilloscope acquisition modes such as Fast Acquisition, for example. When this happens, stop the oscilloscope acquisition and then perform the transfer to the AWG710&AWG710B. Contact the Tektronix Technical support for more information.

About Transferred Files

When you capture a waveform from a selected instrument, the corresponding waveform file is created in the current directory of the current drive. At the same time, the setup file is also created to save the setup information such as amplitude and offset.

Use the setup file to output the waveform file with the same settings as those captured in the instrument.

Waveform Programming Language

This section describes the Waveform Programming Language (WPL) syntax, rules, and command descriptions. There are also a number of programming examples at the end of this section.

Command Syntax

This manual uses the Backus–Naur Form (BNF) notation, shown in Table 3-46, to describe commands.

Table 3-46: BNF symbols and meanings

Symbol	Meaning
< >	Defined element
[]	Optional; can be omitted
...	Previous element(s) may be repeated

General Syntax Rules

Following are the general syntax rules for writing an equation file:

- All spaces, line feeds, and tab codes are ignored unless in a string.
- The concept of a line does not exist.
- All data from a single quote (') to the end of a line is regarded as a comment.
- Alphabetical characters are case-insensitive unless in a string.
- The concept of cursor does not exist. You always work with the whole waveform.
- File attribute functions are unavailable in a waveform expression.
- The maximum length of a string is 256 characters, including spaces. Even if two or more strings are linked by colons (:) in a string expression, the whole length of the linked strings must not exceed 256 characters or an error will occur.
- The total length of strings in the whole equation program can be up to 1,000. (The length is the sum of the number of characters of the string(s) plus a character used as the internal terminal code.)

User-Defined Variables

All user-defined variable names must satisfy the following requirements:

- The first character must be an alphabetical character.
- The rest of the name must consist of an alphabetical character(s), digit(s), and/or an underscore(s) (_).
- The maximum number of characters is 16. All characters in excess of 16 are ignored. Variables that have the same first 16 characters will be regarded as identical.
- Alphabetical characters are case-insensitive. For example, FooBar and foobar are handled as the same variable name.
- You can use user-defined variables in the program without first declaring them.
- User-defined variables are 64-bit floating-point decimal numbers.
- A maximum of 100 variables may be included in a program; this includes the reserved variables, such as clock.
- There are no string variables; all variables require a numeric value.
- Initial variable values are undefined.

The following are unavailable for user-defined variables.

- Reserved word variable names
- Constant names
- Function names
- Keywords (for example, if and marker1)

Waveform Files

Some commands accept a waveform file name enclosed in double quotes. For example: "sinewave.wfm". Observe the following rules when using waveform expressions in equations:

- A quoted string can include any character defined in the 7-bit ASCII character set.
- A numeric value can be embedded in a string in the following format:

"AA":i:".WFM"

If the value of *i* equals 10, the string "AA10.WFM" will result. Before conversion into the string, the value is rounded to the nearest integer.

- One waveform expression can include a maximum of 10 input files. If the same file name appears more than once in a single waveform expression, that file is considered as one file. An exception to this is that "A.WFM" and "A.WFM".marker1 are two different files.
- Signal names, as well as variables, are permitted in a waveform expression. Waveform expressions enable you to specify calculation between waveforms in a similar manner as ordinary expressions. For example, if you code the following:

"A.WFM" = sin(2*pi*scale) + "B.WFM"

A.WFM is produced as the sum of the sinewave equation and B.WFM waveforms.

Waveform Expression

The output name, placed to the left of an '=', and the name used in the expression to the right of an '=' is a <signal-name>. The marker data may be specified as follows in addition to the name of an ordinary waveform file:

"A.WFM".marker2 = "A.WFM" > "B.WFM" > "B.WFM"

In this example, 1 is set if the A.WFM value as the A.WFM marker 2 value is larger than the B.WFM value; 0 is set otherwise. (This is the same as for the compare function of the editor.) The A.WFM analog data is unchanged.

"B.WFM".marker1 = "A.WFM".marker1 + "A.WFM".marker2

In this example, B.WFM's marker1 is set if either marker 1 or 2 of A.WFM is 1.

In a waveform expression, the data length of the file created and the clock information are determined as follows.

If <output-signal-name> is a marker:

If the output file does not already exist, an error will occur. Attributes such as the data length (output file size) and clock information are unchanged. The analog data section does not change. Neither the size or the close variable value is used. If the waveform expression includes a <signal-name>, then a file shorter than the output file would cause an error. If the input file is longer in this case, the data around the tail will not be used.

If <output-signal-name> is analog data:

A new file is always created without using the output file. Since the same file name may be specified for the input, the new file is tentatively created under another file name; then renamed.

All output file marker values will be 0. The output file data length and clock information will be as indicated on the screen.

If the waveform expression includes one or more <signal-name>s:

The output waveform length will equal to that of the shortest waveforms included in the <waveform-expression>. The clock information will match the one appearing first (that is, the one coded at the leftmost) out of those used in the waveform expression.

If the waveform expression includes no <signal-name>:

The output waveform length depends on the size variable value. The clock value depends on the clock variable value.

Command Descriptions

The WPL commands are listed in alphabetical order. Mathematical functions and operators are described under the headings *Math Functions* on page 3-200 and *Math Operators* on page 3-202.

Bpf()

The bpf() statement creates a new waveform file by passing the specified waveform file through a band-pass filter.

Group Waveform

Syntax "output_filename" = bpf("filename1", cutoff_freq_lo,
cutoff_freq_hi, taps, atten)

Arguments "output_filename" is the complete file name (file name and extension) to contain the filtered waveform data. The argument can include a relative or absolute path name. Enclose the file name within double quotation marks.

"filename1" is the complete (file name and extension) name of the source file for the band-pass filter operation. The file must be on the active drive. The argument can include a relative or absolute path name. Enclose the file name within double quotation marks.

cutoff_freq_lo is the band-pass filter low-frequency cutoff value. You can enter the value as a real or scientific notation number or as an expression that resolves to a valid number.

cutoff_freq_hi is the band-pass filter high-frequency cutoff value. You can enter the value as a real or scientific notation number or as an expression that resolves to a valid number.

taps is the number of delay elements that composes the digital filter. The range of taps is 3 to 101. You must enter the integer value as an odd number.

atten is the inhibit zone attenuation factor, in dB. The range of attenuation is 21 dB to 100 dB. You can enter the integer value.

Example "filtered.wfm" = bpf("sine.wfm", 3.0e6, 5.0e6, 101, 35)

Brf()

The brf() statement creates a new waveform file by passing the specified waveform file through a band-rejection filter.

Group Waveform

Syntax "output_filename" = brf("filename1", cutoff_freq_lo,
cutoff_freq_hi, taps, atten)

Arguments "output_filename" is the complete file name (file name and extension) to contain the filtered waveform data. The argument can include a relative or absolute path name. Enclose the file name within double quotation marks.

"filename1" is the complete (file name and extension) name of the source file for the band-pass filter operation. The file must be on the active drive. The argument can include a relative or absolute path name. Enclose the file name within double quotation marks.

cutoff_freq_lo is the band-reject filter low-frequency cutoff value. You can enter the value as a real or scientific notation number or as an expression that resolves to a valid number.

cutoff_freq_hi is the band-reject filter high-frequency cutoff value. You can enter the value as a real or scientific notation number or as an expression that resolves to a valid number.

taps is the number of delay elements that composes the digital filter. The range of taps is 3 to 101. You must enter the integer value as an odd number.

atten is the inhibit zone attenuation factor, in dB. The range of attenuation is 21 dB to 100 dB. You can enter the integer value.

Example "filtered.wfm" = brf("sine.wfm", 3.0e6, 5.0e6, 101, 45)

Code()

The code() statement executes code conversion.

Group Waveform

Syntax "output_filename" = code("filename1", "code@conversion@table")

Arguments "output_filename" is the complete file name (file name and extension) to contain the code-converted waveform data. The argument can include a relative or absolute path name. Enclose the file name within double quotation marks.

"filename1" is the complete (file name and extension) name of the source file for the code conversion operation. The file is 0 1 pattern data. If the file is an analog waveform file, this function reads as 1 if the data value is equal to or larger than 0.5, and 0 if the value is less than 0.5. The argument can include a relative or absolute path name. Enclose the file name within double quotation marks.

"code@conversion@table" is the text file containing a code conversion table in text form. You can use the files that are saved with the Code Conversion Table in the waveform or pattern editor. You can also create those text file each line of which composes of the following five fields delimited by comma (,):

PAST source, Current source, Next source, Past output, Output code

Refer to *The Tools Menu* on page 3-87 for the meaning of each field, and to the *Code Conversion Table Text Files* on page F-12. The argument can include a relative or absolute path name. Enclose the file name within double quotation marks.

Example "C1.WFM" = code("C0.WFM", "nrz.txt")

Conv()

The conv() statement executes convolution between the waveform data of two specified files. All marker values in the output file are set to 0.

Group Waveform

Syntax "output_filename" = conv("filename1", "filename2")

Arguments "output_filename" is the complete file name (file name and extension) to contain the resultant convolution waveform. The argument can include a relative or absolute path name. Enclose the file name within double quotation marks.

"filename1" and "filename2" are the complete (file name and extension) names of the files on which you are performing the convolution. Both files must be on the active drive. The argument can include a relative or absolute path name. Enclose each file name within double quotation marks.

Example `"newsine.wfm" = conv("sine.wfm", "sine2x.wfm")`

Copy()

The copy() statement copies the specified file name to a new file name and/or location on the current drive.

Group Waveform

Syntax `copy("source_file", "target_file")`

Arguments "source_file" is the complete file name (path, file name and extension) to the file that you want to copy. The file must be located on the active drive. The argument can include a relative or absolute path name. Enclose the file name within double quotation marks.

"target_file" is the complete file name (path, file name and extension) to the location to which you are copying the source file. The target file must be located on the active drive. The argument can include a relative or absolute path name. Enclose the file name within double quotation marks.

Example `copy("sine.wfm", "/test_dir/sine2.wfm")`

Corr()

The corr() statement executes correlation between the waveform data of two specified files. All marker values in the output file are set to 0. There are no restrictions on the data lengths of the two waveforms. For markers, the value of the first point is 1, and those of all the others are 0. Refer to *Correlation* on page F-5 for more information.

Group Waveform

Syntax `"output_filename" = corr("filename1", "filename2")`

Arguments `"output_filename"` is the complete file name (file name and extension) to contain the resultant correlation waveform. The argument can include a relative or absolute path name. Enclose the file name within double quotation marks.

`"filename1"` and `"filename2"` are the complete (file name and extension) names of the files on which you are performing the correlation. Both files must be on the active drive. The argument can include a relative or absolute path name. Enclose each file name within double quotation marks.

Example `"corrwave.wfm" = corr("sine.wfm", "sine2x.wfm")`

Data()

The `data()` statement writes the defined data points to the specified file. The number of `<expression>`s specified must equal the number of points. All marker values will be 0. At least one `<expression>` must be included.

Group Waveform

Syntax `"output_filename" = data(data_defn, data_defn, ...)`

Arguments `"output_filename"` is the complete file name (file name and extension) to contain the expanded waveform and marker data. The argument can include a relative or absolute path name. Enclose the file name within double quotation marks.

`data_defn` is a value that defines the data point value. The first data point value starts at point 0. You must include at least one data definition expression. Separate each definition with a comma.

NOTE. *This command lets you create a waveform file that does not meet the instrument waveform minimum data requirement (minimum of 960 points, evenly divisible by four). If you create such a file, open it in a waveform editor, and then attempt to save it, the instrument displays a dialog box asking you to correct the problem. If you attempt to load the waveform in the Setup screen, the instrument displays an error message stating that the file does not have enough data points.*

Example `"foo.wfm" = data(1, 0, .2, .4, .5)`

Delete()

The delete() statement deletes the specified file name from the current drive.

Group Waveform

Syntax delete("filename")\

Arguments "filename" is the complete file name (path, file name and extension) to the file that you want to delete. The file must be located on the active drive. The argument can include a relative or absolute path name. Enclose the file name within double quotation marks.

Example delete("/test_dir/wvfrms/sine2x.wfm")

Diff()

The diff() statement performs a differentiation operation on a specified file. The output file retains all marker values of the input file. Refer to *Differentiation* on page F-1 for information about the differentiation algorithm.

Group Waveform

Syntax "output_filename" = diff("filename")

Arguments "output_filename" is the complete file name (file name and extension) to contain the resultant waveform. The argument can include a relative or absolute path name. Enclose the file name within double quotation marks.

"filename" is the complete (file name and extension) name of the file on which you are performing the differentiation operation. The file must be on the active drive. The argument can include a relative or absolute path name. Enclose the file name within double quotation marks.

Example "diffwave.wfm" = diff("log_swp.wfm")

Expand()

The Expand() statement horizontally expands (scales) the waveform and marker data of the specified waveform file and writes it to a new file.

Group Waveform

Syntax "output_filename" = expand("filename", expand_multiplier)

Arguments "output_filename" is the complete file name (file name and extension) to contain the expanded waveform and marker data. The argument can include a relative or absolute path name. Enclose the file name within double quotation marks.

"filename" is the complete (file name and extension) name of the file on which you are performing the expand operation. The file must be on the active drive. The argument can include a relative or absolute path name. Enclose the file name within double quotation marks.

expand_multiplier is an integer value specifying how much to expand the waveform data. The value must be greater than one. Values less than or equal to one result in the output waveform being the same as the input waveform.

Example "longswp.wfm" = expand("lin_swp.wfm", 2)

Extract()

The extract statement extracts the specified portion of a waveform file and writes it to a new file. The marker data is also extracted. Specify the start and end points to extract the data. Waveform data starts at point 0.

Group Waveform

Syntax "output_filename" = extract("filename", start_point, end_point)

Arguments "output_filename" is the complete file name (file name and extension) to contain the extracted waveform and marker data. The argument can include a relative or absolute path name. Enclose the file name within double quotation marks.

"filename" is the complete (file name and extension) name of the source file for the extract operation. The file must be on the active drive. The argument can include a relative or absolute path name. Enclose the file name within double quotation marks.

`start_point` is the location of the first data point to extract from the input file. This is an integer value. The starting point value must be less than or equal to the ending point value or an error occurs during compilation.

`end_point` is the location of the last data point to extract from the input file. This is an integer value. The ending point value must be greater than or equal to the starting point value or an error occurs during compilation.

NOTE. *This command lets you create a waveform file that does not meet the instrument waveform minimum data requirement (minimum of 960 points, evenly divisible by four). If you create such a file, open it in a waveform editor, and then attempt to save it, the instrument displays a dialog box asking you to correct the problem. If you attempt to load the waveform in the Setup screen, the instrument displays an error message stating that the file does not have enough data points.*

Example `"shortsin.wfm" = extract("sine.wfm", 0, 511)`

For (Control Statement)

The for (control statement) provides a structure for executing one or more equation expressions a defined number of times.

Group Control

Syntax `for <var> = <start> to <end> <expr> next`
 `for <var> = <start> to <end> step <incr> <expr> next`

Arguments `var` is a variable name to contain the for loop count value. A common variable name used for this purpose is `i`. As long as the value of `var` is true (between the start and end values, inclusive), the program executes the expression(s) in the for loop. When `var` is false (`var > end` for `incr > 0`, and `var < end` for `incr < 0`), program flow jumps to the line immediately following next.

`start` is a value or expression that defines the starting number (integer or real) of the for statement loop count.

`end` is a value or expression that defines the end number (integer or real) of the for statement loop count.

`incr` is a value or expression used with the optional `step` keyword to define the size of the loop count increment steps. By default the loop counter increments in steps of 1. The `incr` can be a negative value in which the loop count decrements steps. The increment value is a real or integer number.

NOTE. *Although the `start`, `end`, and `incr` arguments accept real numbers, their values are rounded off to the nearest integer value.*

`expr` is one or more equation expressions that are executed when the for loop condition is true.

Example

```
for i = nsht to (size - nsht -1) step 1
    sp = i - nsht
    ep = i + nsht
    "TEMP1.WFM" = extract("NOISE.WFM", sp, ep)
    "TEMP2.WFM" = "TEMP2.WFM" / nump
next
```

Hpf()

The `hpf()` statement creates a new file by passing the specified waveform file through a high-pass filter.

Group Waveform

Syntax "output_filename" = `hpf`("filename1", cutoff_freq, taps, atten)

Arguments "output_filename" is the complete file name (file name and extension) to contain the filtered waveform data. The argument can include a relative or absolute path name. Enclose the file name within double quotation marks.

"filename1" is the complete (file name and extension) name of the source file for the high-pass filter operation. The file must be on the active drive. The argument can include a relative or absolute path name. Enclose the file name within double quotation marks.

`cutoff_freq` is the high-pass filter cutoff frequency. You can enter the value as a real or scientific notation number. You can also enter the value as an expression that resolves to a valid number.

`taps` is the number of delay elements that composes the digital filter. The range of `taps` is 3 to 101. You must enter the integer value as an odd number.

atten is the inhibit zone attenuation factor, in dB. The range of attenuation is 21 dB to 100 dB. You can enter the integer value.

Example `"filtered.wfm" = hpf("sine.wfm", 3.25e5, 2, 25)`

If (Control Statement)

The if(control statement) provides control statements to execute expressions when a condition resolves to true or false.

Group Control

Syntax `if <condition> then <expr1> endif`
`if <condition> then <expr1> else <expr2> endif`

Arguments `condition` is a conditional expression that resolves to a logical true or false. True equals any nonzero value; false equals zero. When the condition is true, the expression statement is run.

`expr1` is an equation expression you want to execute when condition is true.

`expr2` is an equation expression you want to execute when condition is false. This argument is only valid as part of the else statement of an if/then/else/endif control construct.

Example `if cc = 1 then`
`"SMOOTH.WFM" = "TEMP2.WFM"`
`else`
`"SMOOTH.WFM" = join("SMOOTH.WFM", "TEMP2.WFM")`
`endif`

Integ()

The integ() statement performs an integration operation on a specified file. The output file retains all marker values of the input file. Refer to *Integral* on page F-3 for information about the integration algorithm.

Group Waveform

Syntax `"output_filename" = integ("filename")`

Arguments "output_filename" is the complete file name (file name and extension) to contain the resultant waveform. The argument can include a relative or absolute path name. Enclose the file name within double quotation marks.

"filename" is the complete name (path, file name and extension) of the source file for the integration operation. The file must be on the active drive. The argument can include a relative or absolute path name. Enclose the file name within double quotation marks.

Example "intwave.wfm" = integ("sineswp.wfm")

Join()

The join() statement joins (concatenates) two waveform files (waveform and marker data) into a single file. The clock sample rate in first file sets the clock sample rate for the output file waveform. You can only concatenate waveform (.wfm) files.

Group Waveform

Syntax "output_filename" = join("filename1", "filename2")

Arguments "output_filename" is the complete file name (file name and extension) to contain the concatenated files. The argument can include a relative or absolute path name. Enclose the file name within double quotation marks.

"filename1" and "filename2" are the complete names (path, file name, and extension) of the files you are concatenating. Both files must be on the active drive. The argument can include a relative or absolute path name. Enclose each file name within double quotation marks.

Example "newsine.wfm" = join("sine.wfm", sine2.wfm")

Lpf()

The lpf() statement creates a new file by passing the specified waveform file through a low pass filter.

Group Waveform

Syntax "output_filename" = lpf("filename1", cutoff_freq, taps, atten)

Arguments "output_filename" is the complete file name (file name and extension) to contain the filtered waveform data. The argument can include a relative or absolute path name. Enclose the file name within double quotation marks.

"filename1" is the complete (file name and extension) name of the source file for the low pass filter operation. The file must be on the active drive. The argument can include a relative or absolute path name. Enclose the file name within double quotation marks.

cutoff_freq is the low pass filter cutoff frequency. You can enter the integer value.

taps is the number of delay elements that composes the digital filter. The range of taps is 3 to 101. You must enter the integer value as an odd number.

atten is the inhibit zone attenuation factor, in dB. The range of attenuation is 21 dB to 100 dB. You can enter the integer value.

Example "filtered.wfm" = lpf("sine.wfm", 10.454e2, 2, 30)

Math Functions

Table 3-47 lists the programming language math functions that you can use as part of a waveform equation expression.

Table 3-47: Programming language math functions

Function	Description
abs(<i>a</i>)	Absolute value of <i>a</i> .
acos(<i>a</i>)	Arc cosine of <i>a</i> .
asin(<i>a</i>)	Arc sine of <i>a</i> .
atan(<i>a</i>)	Arc tangent of <i>a</i> .
ceil(<i>a</i>)	Minimum integer greater than or equal to <i>a</i> .
cos(<i>a</i>)	Cosine of <i>a</i> .
cosh(<i>a</i>)	Hyperbolic cosine of <i>a</i> .
exp(<i>a</i>)	Exponential function of base of natural logarithm for <i>a</i> .
floor(<i>a</i>)	Maximum integer less than or equal to <i>a</i>
int(<i>a</i>)	Truncation (Same as floor(<i>a</i>) if <i>a</i> >= 0; same as ceil(<i>a</i>) if <i>a</i> < 0)
log(<i>a</i>)	Natural logarithm of <i>a</i> .
log10(<i>a</i>)	Base 10 logarithm of <i>a</i> .
max(<i>a</i> , <i>b</i>)	Returns larger (maximum) value of <i>a</i> and <i>b</i> .

Table 3-47: Programming language math functions

Function	Description
$\min(a, b)$	Returns smaller (minimum) value of a and b .
noise()	Generates pseudo Gaussian distribution white noise signal with a standard deviation (= RMS) of 1.
$\text{pow}(a, b)$	Exponentiation (b th power of a , or a^b) A negative value may be specified for a only if b is an integer. Otherwise, NaN will result. The pow function returns one of the following values: If $b = 0$: Always 1 If $b \neq 0$ and $a = 0$: Always 0 If $b \neq 0$ and $a < 0$ and b is a positive integer: a^b If $b \neq 0$ and $a < 0$ and b is a negative integer: Reciprocal of $a^{(-b)}$ If $b \neq 0$ and $a < 0$, NaN (Not a Number)
rnd()	Returns a random number in the 0 to 1 range. Generated base seed = $(253 * \text{seed} + 1) \% 16777216$, return seed/16777216. Seed is a 32-bit unsigned integer.
round(a)	Rounds off the value of a to an integer.
saw(a)	Saw tooth wave with a cycle of 2π and an amplitude ± 1 . If $a = -2\pi, 0, 2\pi, 4\pi$, or 6π , etc., the value is -1. The value approaches 1 at points immediately before these. (This function will not take the value 1.0.)
sign(a)	Sign of a (1 if $a > 0$; -1 if $a < 0$; 0 if $a = 0$).
sin(a)	Sine value of a .
sinc(a)	Same as $\sin(a)/a$, except that 1 results if $a=0$.
sinh(a)	Hyperbolic sine value of a .
sqr(a)	Rectangular wave with a cycle of 2π and an amplitude ± 1 . If k is an even: For $a = k\pi$ to $(k+1)\pi$, sqr returns -1, except +1.0 when a equals $(k+1)\pi$. If k is an odd: For $a = k\pi$ to $(k+1)\pi$, sqr returns +1, except -1.0 when $a = (k+1)\pi$.
sqrt(a)	Square root value of a .
srnd($seed$)	Sets the random number generator seed value. Seed is 0 to $2^{31}-1$. Default value is 0.
tan(a)	Tangent value of a .
tanh(a)	Hyperbolic tangent value of a .
tri(a)	Triangular wave with a cycle of 2π and an amplitude ± 1 . If $a = 0$, the value is 0. If $a = 0.5\pi$, it is 1.0. If $a = \pi$, it is 0.0. If $a = 1.5\pi$, it is -1.

Math Operators

Table 3-48 lists the programming language math operators that you can use as part of waveform equation expressions.

Table 3-48: Math operators

Operators	Description
Unary Arithmetic Operations	
-	Inverts the sign.
+	Does nothing.
Binary Operations	
+	Addition
-	Subtraction
*	Multiplication
/	Division
^	Exponentiation
Binary Relational Operations	
=	If both side values are equal, 1 results. Otherwise, 0 results.
<>	If both side values are not equal, 1 results. Otherwise, 0 results.
>	If the left side value is larger than the right side value, 1 results. Otherwise, 0 results.
>=	If the left side value is larger than or equal to the right side value, 1 results. Otherwise, 0 results.
<	If the left side value is smaller than the right side value, 1 results. Otherwise, 0 results.
<=	If the left side value is smaller than or equal to the right side value, 1 results. Otherwise, 0 results.
Binary Conditional Operator	
and	If both side values are not 0, 1 results. Otherwise 0 results.
or	If both side values are 0, 0 results. Otherwise 1 results.

The operator priorities are as follows, starting with higher priority at the top of the list. Operators on the same line have equal priority.

^
 - (unary), + (unary)
 *, /
 =, <>, >, >=, <, <=
 and, or

NOTE. Exponentiation executes the same calculation as for the `pow()` function. Zero (0) divided by 0 is 1.

Norm()

The `norm()` statement performs a normalization operation on a specified file waveform data. Normalization scales the waveform values to a ± 1.0 range, centered on 0. The output file retains all marker values of the input file.

Group Waveform

Syntax `"output_filename" = norm("filename1")`

Arguments `"output_filename"` is the complete file name (file name and extension) to contain the resultant waveform. The argument can include a relative or absolute path name. Enclose the file name within double quotation marks.

`"filename1"` is the complete (file name and extension) name of the file on which you are performing the normalization operation. The file must be on the active drive. The argument can include a relative or absolute path name. Enclose the file name within double quotation marks.

Example `"intwave.wfm" = norm("sineswp.wfm")`

Pn()

The `pn()` statement creates a pseudo-random waveform using a shift register. You can specify the register size (1 to 32) and XOR feedback tap position. The initial values of the registers are set to one. If you omit the tap position specifier, a default maximum data length tap setting is used.

Group Waveform

Syntax `"output_filename" = pn(reg_size [, tap_position ...])`

Arguments `"output_filename"` is the complete file name (file name and extension) to contain the pseudo-random waveform. The argument can include a relative or absolute path name. Enclose the file name within double quotation marks.

`reg_size` specifies the number of registers in the pseudo-random generator. This is an integer value from 1 to 32.

`tap_position` specifies the register positions to 'tap' for XOR feedback to the register input. A tap does an XOR operation on the output signal and the specified register and passes the result to the next-lower tap position or the register input (register 1), whichever it encounters first. Refer to *Shift Register Generator...* on page 3-66 for more information.

Example `"random.wfm" = pn(12, 3, 6, 8)`

Rename()

The `rename` statement renames the specified file name to a new file name and/or location on the current drive.

Group Waveform

Syntax `rename("source_file", "target_file")`

Arguments `"source_file"` is the complete file name (path, file name and extension) to the file that you want to rename. The file must be located on the active drive. The argument can include a relative or absolute path name. Enclose the file name within double quotation marks.

`"target_file"` is the complete file name (path, file name and extension) to the location to which you are renaming the source file. The target file must be located on the active drive. The argument can include a relative or absolute path name. Enclose the file name within double quotation marks.

Example `rename("/test_dir/sine.wfm", "/test_dir/old_sine.wfm")`

Variables (predefined)

The following table lists predefined programming language variables that you can use as part of a waveform equation expression (except where noted).

Table 3-49: Predefined variables

Function	Description
clock	Sets the current instrument sample clock rate.
fname.clock	Returns the sample clock rate of the specified file name. You cannot use this variable in a waveform expression.
pi	The Ludolphian number π .
point	Current data point number value, starting at 0. Read only. Only useable within an equation expression.
scale	Returns the current scale value that increase 0 to 1. Read only. Only useable within an equation expression.
size	Sets the current waveform record length.
fname.size	Returns the number of waveform data points of the specified file name. You cannot use this variable in a waveform expression.
time	Current data time value, starting at 0. Read only. Only useable within an equation expression.

Write()

The write() statement writes the specified text to a new file name and/or location on the current drive. If an output file already exists, the source file contents are appended to the end of the existing file.

Group Waveform

Syntax write("output_filename", "text" [,"text" ...])

Arguments "output_filename" is the complete file name (path, file name, and extension) to the file that you want to write. The file must be located on the active drive. The argument can include a relative or absolute path name. Enclose the file name in double quotation marks.

"text" is the text string enclosed in double quotation marks. If you need to use a double quotation mark as part of the text, precede each double quotation character with a slash character (\). For example:

This function writes a text to a \"ABC.TXT\" in text form."

In a similar way, the following codes can be used in text strings:

\n — LF
\r — CR
\t — Tab
\ — Backslash
\" — Double-quote

Example write("sine.wfm", "This is comment line.")

Programming Examples

The following eight equation programming examples are described below.

Examples	Key points to be learned
Example 1	Describes how to create waveform file, and how to read and write waveform files.
Example 2	Describes how to use <i>for</i> loop and <i>if</i> conditional branch statements.
Example 3	Describes how to put comments, and how to create sequence file.
Example 4	Describes how to use marker data and how to use the binary relational operations in the assignment statement.
Example 5	Describes how to use digital filter functions.
Example 6	Describes how to use <i>data()</i> and <i>code()</i> functions.
Example 7	Describes how to handle specific point data in the waveform file using the <i>extract()</i> , <i>join()</i> and <i>integ()</i> function, and also the <i>for</i> and <i>if</i> statement.
Example 8	Creates the equation file to generate the four waveforms and two sequence files used in the Sequence editor tutorial in the <i>Getting Started</i> section.
Others	Refer to <i>Appendix D: Sample Waveforms</i> for more equation examples. Most of the waveforms in the appendix were created by the listed equations.

Example 1 The example below creates three waveform files: *a.wfm*, *b.wfm* and *c.wfm*.

```
size = 2000
"a.wfm" = cos (2 * pi * scale)

size = 1512
"b.wfm" = cos (2 * pi * scale)
"c.wfm" = "a.wfm" * "b.wfm"
```

The first and third lines define the waveform record length (in points). You can change the record length any time within an equation; all created files use the last-set size value. When you do not define the waveform record length, the instrument uses the default length of 1000.

The second line generates the waveform *a.wfm* with 2000 data points. The *scale* is the system-used variable to fit the generated waveform within the ± 1.0 vertical scale range.

The waveform *c.wfm* has the point size of 1512 and is generated by multiplying the *a.wfm* and *b.wfm* waveforms.

When you perform the operation between the waveforms which have a different point size, the lowest point size among them is used. Therefore the c.wfm will have the point size of 1500.

Figure 3-63 shows the waveforms to be generated by the above example.

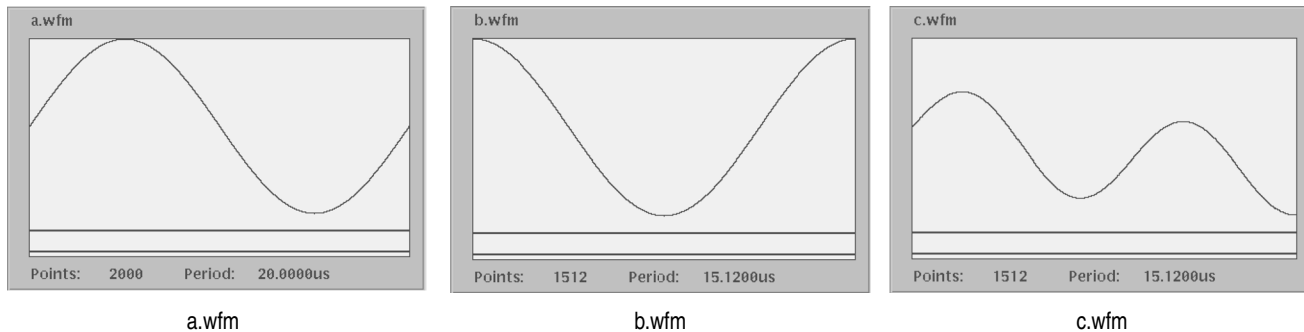

Figure 3-63: Waveforms generated from the Example 1 equation

Example 2 Below is an example in which the *for* and *if* statements are used.

```

num = 30
  for i = 1 to num
    if i = 1 then
      "t.wfm"=cos(2*pi*scale)
    else
      "t.wfm"="t.wfm"+cos(2*pi*i*scale)
    endif
  next

  "t.wfm"="t.wfm"/num

```

Num and *i* are user-defined variables. *I* is used as part of the *for* loop parameter. The statements placed between the *for* and *next* keywords repeat 30 times while the *i* increments by 1 for each loop.

The conditional branch statement must start with the *if* keyword and end with the *endif* keyword. In the above example, if *i* = 1, the equation creates the waveform *t.wfm*. When *i* ≠ 1, the newly created waveform and the one created in the previous loop are added, and the result is stored in the waveform *t.wfm*. The resultant waveform is then normalized.

Figure 3-64 shows the waveform generated by the previous example.

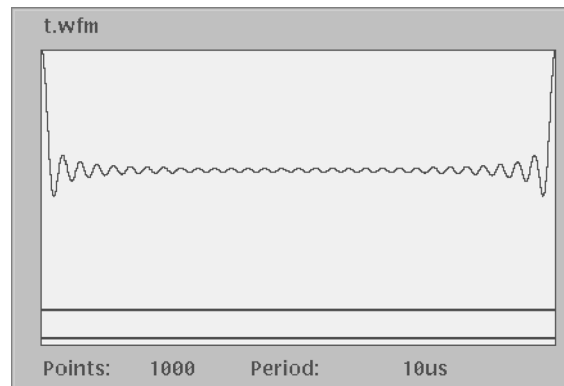

Figure 3-64: Waveform generated by the Example 2 equation

Example 3 The following example creates one sequence file and four waveforms.

```

delete("test.seq")

size=1000
clock=1e9
num=4

`write sequence file header
write("test.seq","3002A\n")
write("test.seq","LINES ":num:"\n")

for i = 1 to num
    `create a waveform file
    "test":i:".wfm" = sin(2 * pi * i * scale)

    `add line to sequence file
    rep = num * i
    write("test.seq","\\"test":i:".wfm\\","\\"",":rep:"\n")
next

```

The first line is the statement for deleting the existing waveform. If that file does not exist, then no action is taken.

The *size* and *clock* keywords are the system valuables representing the waveform record length, in points, and the sampling clock frequency. They are set to 1000 points and 1.0 GS/s in the above example.

The comment text on line 5 starts with a single quotation (') character. Comment text is effective until the end of the line containing the single-quote character.

The *write* command writes the specified text to the specified file. If the file being written to exists, the write command appends the specified string to the end of the file. The first argument is the file to which the strings specified as the second argument and after will be written. The string must be enclosed in double quotation marks. If you desire to use a variable as a string, you must place the colon (:) before and after the variable. For example:

```
"text":i:".wfm"
```

In the above example, if the variable *i* is currently 5, the value of the string will be *text5.wfm*. The slash is used as an escape character, and precedes the double quotation marks in a string. The '\n' inserts an end of line (EOL) character in the file.

The sequence file is a text file which has the number 3002 on the first line of the text and the number of lines (for example LINES 4) on the second line.

Figure 3-65 shows the four waveforms generated by example 3. Figure 3-66 shows the sequence table created by example 3.

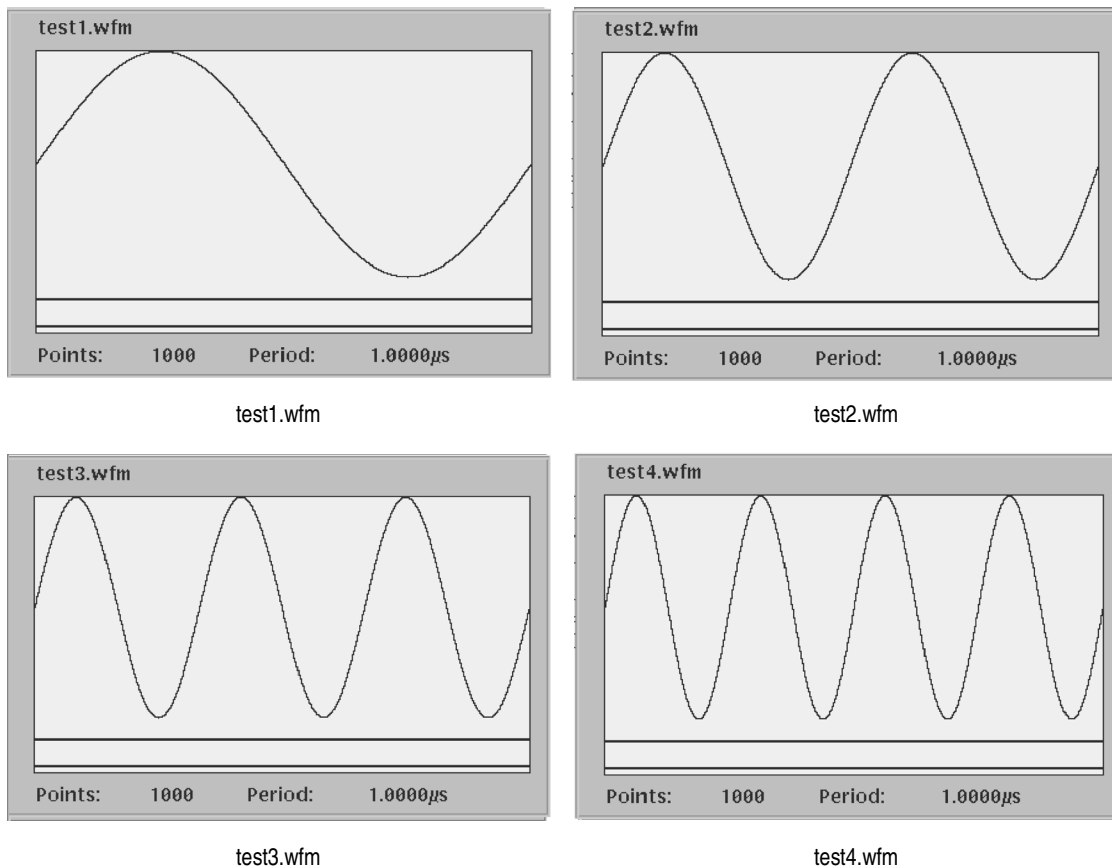

Figure 3-65: Waveforms generated by the Example 3 equation

Line	CH1	Repeat Count	Wait Trigger	Goto <N>	Logic Jump
1	test1.wfm	4			
2	test2.wfm	8			
3	test3.wfm	12			
4	test4.wfm	16			
-	-	-	-	-	-

File Data Entry Line Edit Jump Mode Event Jump Move Cursor to Undo!

Figure 3-66: Sequence generated by the Example 3 equation

NOTE. The equation/text editor has a viewer that displays the waveforms after the compile has been performed. However, this viewer cannot display the sequence. Use the sequence editor to confirm the results.

Example 4 The following example shows how to use boolean relational operations between a waveform and its marker data.

```

delete("MOD01.WFM")
delete("MOD02.WFM")

"Mod.wfm" = sin (2 * p * scale)

"MOD01.WFM" = "MOD.WFM"

"MOD01.WFM".marker1 = "MOD01.WFM" >= 0.5
"MOD01.WFM".marker2 = "MOD01.WFM" <= -0.5

"MOD02.WFM" = ("MOD01.WFM".marker1 = "MOD01.WFM".marker2) / 2

```

The boolean relational operation results in a 1 value if the condition is true, and a 0 value if the condition is false. Therefore the MOD01.WFM marker1 signal is 1 if the waveform data is greater than or equal to 0.5, and 0 for all other values. Likewise, the marker2 signal is 1 if the waveform data is less than or equal to -0.5, and 0 for all other values.

The MOD02.WFM signal is 0.5 if the marker1 signal of the MOD01.WFM is equal to the marker2 signal, otherwise the signal value is 0.

The results are shown in Figure 3-67.

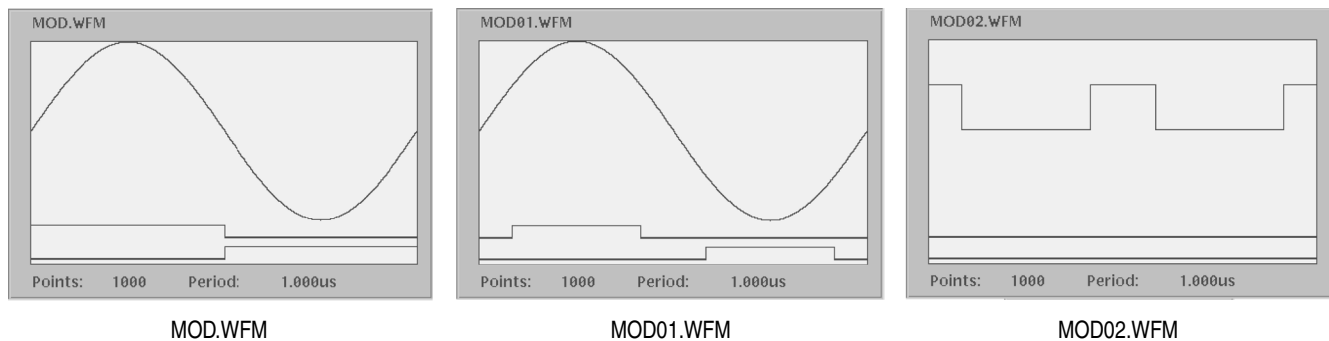

Figure 3-67: Source waveform and those generated by the Example 4 equation

Example 5 The following example shows how to use filter functions. There are four digital filter functions: lpf(), hpf(), bpf() and brf(), which are the same as those provided in the digital filter dialog box of the waveform editor. Refer to *Digital Filter...* on page 3-78 for more information on the filter arguments and the digital filter characteristics.

```

size = 2000

hf = 45e6      ' Cutoff frequency High: 1 Hz to 50 MHz
lf = 5e6      ' Cutoff frequency Low: 1 Hz to 50 MHz
taps = 97     ' Taps: 3 to 101
att = 30      ' Attenuation: 21 dB to 100 dB

"NOISE.WFM" = noise()
"NOISE.WFM" = norm("NOISE.WFM")

"N1.WFM" = lpf("NOISE.WFM", lf, taps, att)
"N2.WFM" = hpf("NOISE.WFM", hf, taps, att)
"N3.WFM" = bpf("NOISE.WFM", lf, hf, taps, att)
"N4.WFM" = brf("NOISE.WFM", lf, hf, taps, att)
    
```

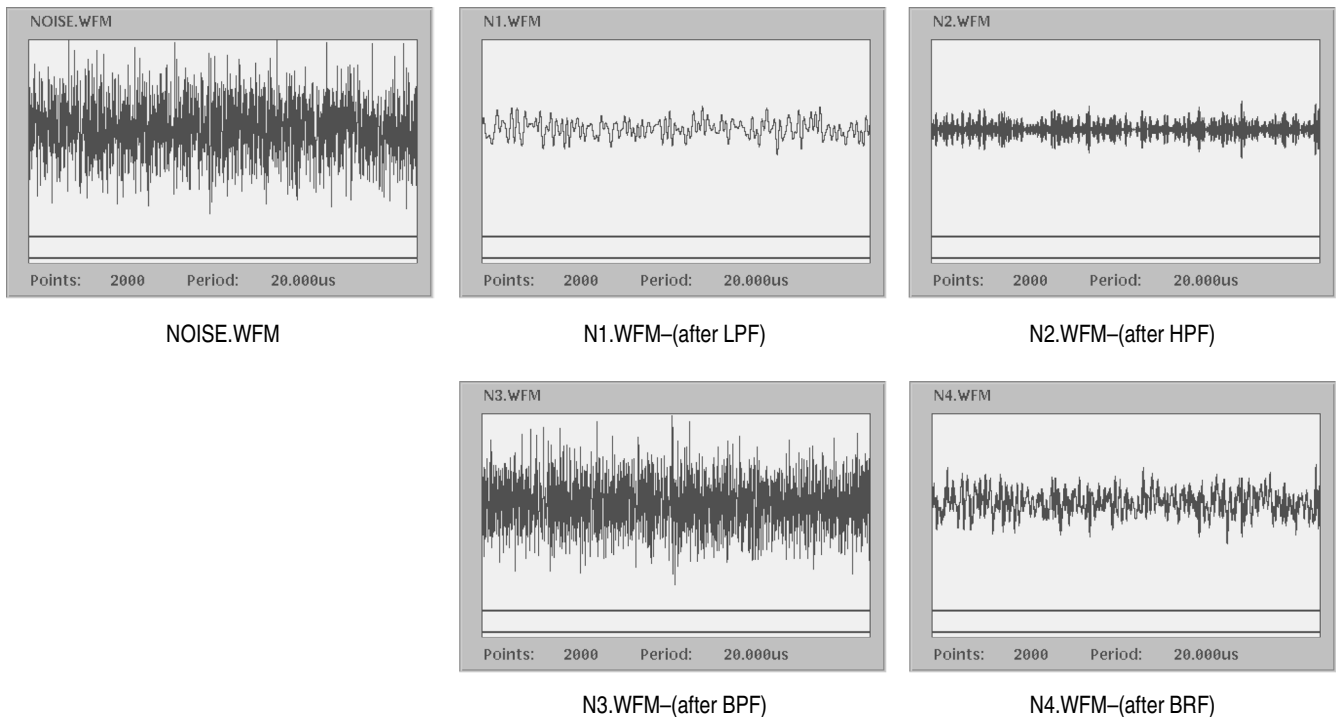

Figure 3-68: Noise waveforms after filtering

Example 6 The following example shows a code conversion. In this example, two kinds of data are created with *data()* function. You need to prepare the code conversion tables which can be created with the text editor or Code Convert Table dialog box. The Code Convert Table dialog box is brought up by pushing **Tools** (bottom)→**Code Convert...** (pop-up)→**OK** (side)→**Edit...** (side) from the waveform or pattern editor.

```
"C0.WFM" = data(0, 1, 0, 0, 1, 1, 0, 0, 0)

"C1.WFM" = code("C0.WFM", "nrz.txt")
"C2.WFM" = code("C0.WFM", "nrzi.txt")
"C3.WFM" = code("C0.WFM", "nrzi-2.txt")
"C4.WFM" = code("C0.WFM", "fm.txt")
"C5.WFM" = code("C0.WFM", "bi-phase.txt")
"C6.WFM" = code("C0.WFM", "rz.txt")
"C7.WFM" = code("C0.WFM", "special.txt")

"C0.WFM" = data(0,1,1,0,1,1,0,0,1,0,1,0,0,0,1,1,1,1,0,
0,0,1,0,0,1,1,1,0,0,0,0,0)
"C8.WFM" = code("C0.WFM", "1-7rill.txt")
```

The waveforms generated by the previous equation file are composed of 0 and 1. It is convenient to use the waveform editor in table mode to look at the results. Refer to *Code Conversion* on page F-7 for the input patterns, output patterns and code conversion tables.

Example 7 The following example applies a 7–point smoothing operation to a noise waveform. This equation uses the *extract()*, *integ()* and *join()* functions, and also *for* and *if* control statements. Although you do not have any other method to perform smoothing with the instrument, this is not a preferable way to apply a smoothing operation. Refer to this example for learning how to use these functions and control statements.

You can change the number of smoothing points by changing the value of the variable *nump*. The greater the value of *nump*, the faster the instrument can finish the compile. However, this kind of program frequently accesses the hard disk and takes more than 20 minutes to complete.

```

^ Simple smoothing (7 points)

nump = 7
extp = nump - 1
nsht = extp / 2
size = 960

"NOISE.WFM" = noise()
"NOISE.WFM" = norm("NOISE.WFM")

cc = 1
for i = nsht to (size - nsht -1) step 1
    sp = i - nsht
    ep = i + nsht
    "TEMP1.WFM" = extract("NOISE.WFM", sp, ep)
    "TEMP1.WFM" = integ("TEMP1.WFM")
    "TEMP2.WFM" = extract("TEMP1.WFM", extp, extp)
    "TEMP2.WFM" = "TEMP2.WFM" / nump
    if cc = 1 then
        "SMOOTH.WFM" = "TEMP2.WFM"
    else
        "SMOOTH.WFM" = join("SMOOTH.WFM", "TEMP2.WFM")
    endif
    cc = cc + 1
next

delete("TEMP1.WFM")
delete("TEMP2.WFM")

```

The following text describes what happens in this example:

1. The *noise()* function generates a noise waveform into the file NOISE.WFM, in which the waveform data are normalized using the *norm()* function.
2. The *extract()* function extracts the data sp through ep and stores them into the file TEPM1.WFM.
3. The *integ()* function integrates the 7 data. The data of last point is the amount of 7 point data. This last data is divided by 7 and then concatenated to the file SMOOTH.WFM.
4. The *for* statement shifts the points to be read by one point for each loop and repeats these procedures.

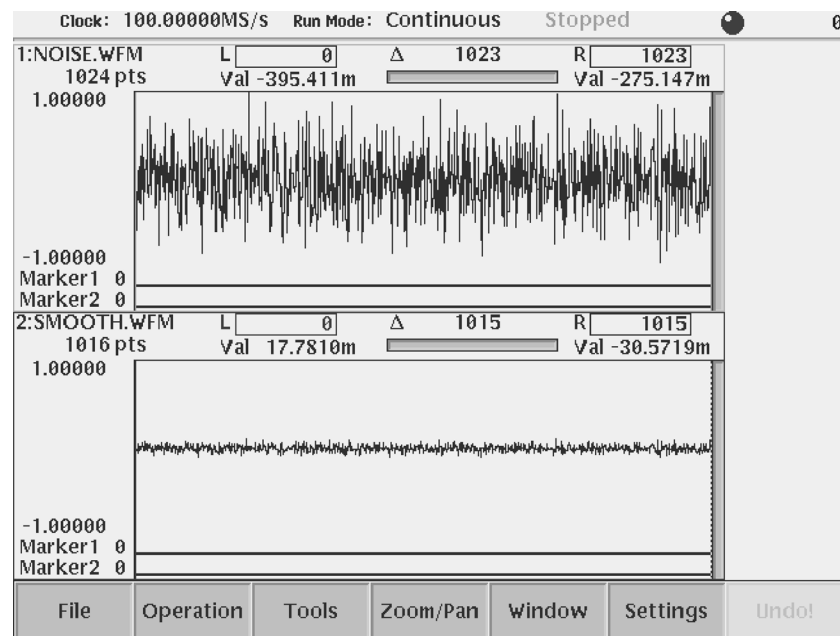

Figure 3-69: Noise waveforms before (upper) and after (lower) 7-point smoothing

Example 8

The following example creates two sequence files and five waveform files. These files are the same as those used in the *Tutorial 6: Creating and Running Waveform Sequences* beginning on page 2-70.

```

^ Tutorial 6
delete("MAINSEQ.SEQ")
delete("SUBSEQ.SEQ")

```

```

size = 1000
clock = 1e8
num = 4

^ Sub-sequence
write("SUBSEQ.SEQ", "MAGIC 3002A\n")
write("SUBSEQ.SEQ", "LINES ":num:"\n")
write("SUBSEQ.SEQ", "\"SQUARE.WFM\", \"\", 40000\n")
write("SUBSEQ.SEQ", "\"RAMP.WFM\", \"\", 60000\n")
write("SUBSEQ.SEQ", "\"TRIANGLE.WFM\", \"\", 60000\n")
write("SUBSEQ.SEQ", "\"SINE.WFM\", \"\", 30000\n")

^ Main sequence
write("MAINSEQ.SEQ", "MAGIC 3002A\n")
write("MAINSEQ.SEQ", "LINES ":num:"\n")
write("MAINSEQ.SEQ", "\"SUBSEQ.SEQ\", \"\", 2,1,0,0\n")
write("MAINSEQ.SEQ", "\"RAMP.WFM\", \"\", 0,0,0,-1,0\n")
write("MAINSEQ.SEQ", "\"TRIANGLE.WFM\", \"\", 40000,0,0,4,1\n")
write("MAINSEQ.SEQ", "\"SINE.WFM\", \"\", 60000,0,0,0,0\n")
write("MAINSEQ.SEQ", "TABLE_JUMP
0,0,0,0,0,0,0,0,0,0,0,0,0,0,0,0,\n")
write("MAINSEQ.SEQ", "LOGIC_JUMP -1,-1,-1,-1,\n")
write("MAINSEQ.SEQ", "JUMP_MODE LOGIC\n")
write("MAINSEQ.SEQ", "JUMP_TIMING ASYNC\n")
write("MAINSEQ.SEQ", "STROBE 0\n")

^ Standard functions
"GAUSSN.WFM" = noise()
"SINE.WFM"   = sin(2 * pi * scale)
"RAMP.WFM"  = 2 * scale -1
"TRIANGLE.WFM" = tri(2 * pi * scale)
"SQUARE.WFM" = sqr(2 * pi * scale)

```

See Figure 2-45 on page 2-75 to see the contents of the *subseq.seq* file, and Figure 2-49 on page 2-80 to see the contents of the *mainseq.seq* file. Figure 3-70 on page 3-217 shows the *gaussn.wfm* and *ramp.wfm* waveforms created in above equation.

Refer to *Appendix G: Sequence File Text Format* for more information.

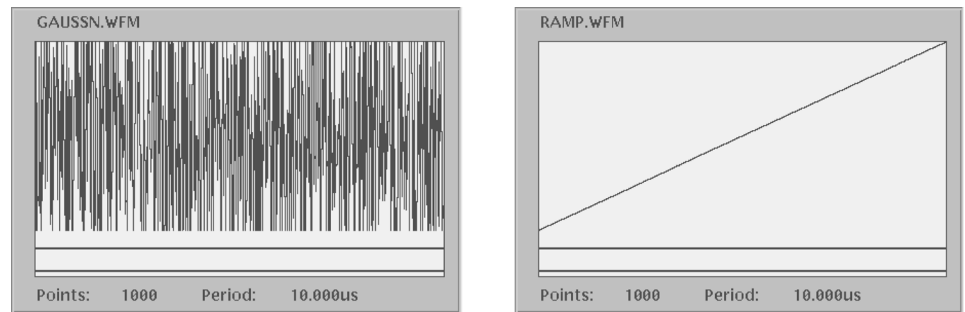

Figure 3-70: Gaussian noise and ramp waveforms

File Conversion

The AWG710&AWG710B Arbitrary Waveform Generator has the ability to import and export various formats of waveform data. Import converts waveform files created with other instruments into files the AWG710&AWG710B Arbitrary Waveform Generator can use. Export converts AWG710&AWG710B Arbitrary Waveform Generator waveform files into text files.

Each AWG710&AWG710B Arbitrary Waveform Generator waveform file contains the clock rate information, waveform data, and marker information. Import uses default values for the information unavailable through the external file.

Import

The following files can be converted into AWG710&AWG710B Arbitrary Waveform Generator compatible waveform files:

- AWG20xx.WFM to Waveform

An AWG2000 Series *.wfm* file is converted into an AWG710&AWG710B Arbitrary Waveform Generator waveform file. The marker data and clock rates are inherited.

- AWG20xx.WFM to Pattern

An AWG2000 Series *.wfm* file is converted into an AWG710&AWG710B Arbitrary Waveform Generator pattern file. The marker data and clock rates are inherited.

Note that the upper 8 bits in the AWG2021 or AWG2005 waveform file are converted into the AWG710&AWG710B Arbitrary Waveform Generator waveform file. The lower four bits are neglected. In the AWG2041 waveform file, 8-bit data is imported with no convention into the data bits: Data 0 to Data 7 in the AWG710&AWG710B Arbitrary Waveform Generator pattern file.

- TDS.WFM to Waveform

A waveform file generated with a Tektronix TDS-Series oscilloscope is converted into an AWG710&AWG710B Arbitrary Waveform Generator waveform file. The clock rate and position information are inherited. The offset information is neglected in this conversion.

The AWG710&AWG710B Arbitrary Waveform Generator is unable to transfer waveforms during some oscilloscope acquisition modes such as Fast Acquisition, for example. Contact Tektronix Technical support for more information.

■ TDS.ISF to Waveform

A waveform file generated with a Tektronix TDS3000 series oscilloscope Internal File Format is converted into an AWG710&AWG710B Arbitrary Waveform Generator waveform file. The clock rate and position information are inherited. The offset information is neglected in this conversion.

■ EASYWAVE.WAV to Waveform

A data file (.wav) generated with LeCroy EASYWAVE software is converted into the AWG710&AWG710B Arbitrary Waveform Generator waveform file. No attributes are inherited.

■ Text file to Waveform

An ASCII-form text file is converted into the AWG710&AWG710B Arbitrary Waveform Generator waveform file. Numeric values separated by separators are loaded. Headers or similar codes are not defined. The separator can be a space, comma, tab, or <CR><LF>.

An exponential notation (for example, $-1E-2$) may be used as a numeric value. A unit prefix (for example, m, u, n, p, k, M) may not be used. If you use a numeric value followed by an alphabetical character (such as, 1.2 V), the value will be interpreted properly, ignoring the alphabetical character.

If you use a sequence of consecutive separators, it will be interpreted as a single separator.

Therefore, the meaning of the following line:

1,2,3,4<CR> <LF>

is the same as:

1 , 2 , 3,, 4 ,, <CR> <LF>

If an alphabetical character (such as A, B, C, and/or D) is placed instead of a numeric value, the value 0 will result. (This is not handled as an error.)

The actual input file formats are as follows:

Format 1: Numeric values that are listed horizontally

0,0.1,0.2,0.3,0.4

The respective values are converted into the analog data. The marker value is converted into 0.

Format 2: Repetitions of three numeric values listed on a line:

```
0.1,1,0
0.2,0,1
0.3,0,0
```

One line corresponds to 1 point. The first value is the analog data, and the subsequent two are markers 1 and 2. For marker data, values larger than 0.5 are regarded as 1, and the others as 0.

Export

AWG710&AWG710B Arbitrary Waveform Generator waveform files can be converted into the following files. You may use a format including marker data and one not including it.

- Waveform to text file
- Waveform to text file with marker

For both file types, 1–point data is written on a line. The return code is CR/LF.

If no marker is included:

```
1.0
0.5
-0.9
0.1
```

If markers are included:

```
1.0,1,1
0.5,0,1
-0.9,1,0
0.1,0,0
```

Convert between Waveform and Pattern

AWG710&AWG710B Arbitrary Waveform Generator waveform files and pattern files can be converted from one form to the other.

- Waveform to Pattern
- Pattern to Waveform

In this conversion, the marker data is always inherited.

Executing File Conversion

This command converts the file you selected in the **EDIT** menu. It is available for any file residing on the hard or floppy disk or a remote file system.

1. Push the **EDIT** button on the front panel.

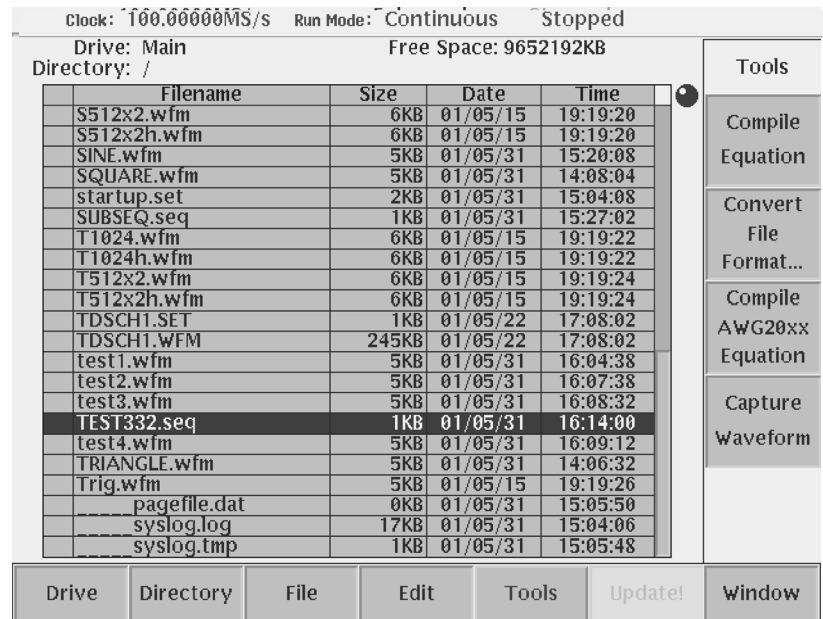

Figure 3-71: Screen and side menu buttons for importing and exporting

2. Select the file you want to convert from the file listing on the screen.
3. Push **Tools** (bottom)→**Convert File Format...** (side). A dialog box appears that lets you select the conversion type. See Figure 3-72.

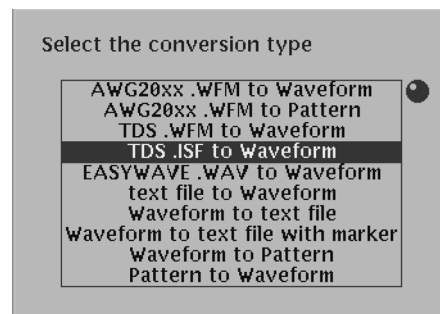

Figure 3-72: Select the conversion type dialog box

4. Select a conversion type using the general purpose knob or the ▲ or ▼ button.
5. Push the **OK** side button. The Input Filename dialog box appears that lets you specify the converted file name and the destination.
6. Enter a file name and then press the **OK** side button.

File Management

This section describes the AWG710&AWG710B Arbitrary Waveform Generator file management commands and conventions.

Command Summary

Table 3-50 lists the available file management commands.

Table 3-50: File utility commands

Commands	Descriptions
Copy	Copies a file
Rename	Renames a file or directory
Delete	Deletes a file or directory
Delete All	Deletes all files and directories containing files in the current directory
Attribute	Assigns Read/Write or Read Only attribute to a file
Make Directory	Creates an empty directory
Up Level	Moves to the upper level directory
Down Level	Moves down to a selected directory
Drive	Selects a storage drive

Path Name

You can specify a file or directory location using the absolute path or relative path expression. The AWG710&AWG710B Arbitrary Waveform Generator uses the same file expression as used in the UNIX file system. Table 3-51 shows the characters available for specifying direct or indirect path names.

Table 3-51: Special symbols used for expressing file path

Symbols	Descriptions
.	Represents current directory
..	Represents higher level directory
/	Represents top level directory (root directory) or delimiter. If the slash appears at the most-left position in a path, the path represents an absolute path. If the slash appears in the middle of a path, the path represents a relative path.

NOTE. You cannot specify the storage drive as part of a file path name. You must use the menu Drive buttons to specify a drive.

File Operations

For file operations, you can select Single Window or Double Windows.

In the Double Windows, you can copy or move a file or all files from the currently selected window to the destination specified by the other window. You cannot rename, delete, or assign attribute operations in the Double Windows.

The following text describes how to perform file management tasks.

Selecting a Drive

Drives include the instrument hard disk drive, the instrument floppy disk drive, and up to three drives accessible from the instrument over the Ethernet connection. Do the following steps to select a new source or target drive.

1. Push **EDIT** (front-panel)→**Drive** (bottom).
2. Select a storage drive from the side menu.

NOTE. The floppy disk file list displayed on the screen does not automatically update when you replace the diskette with another one. Select the floppy disk drive once again to update the file list.

Moving Directories Do the following steps to move to a different directory:

1. Push the **EDIT** button.
2. Select a drive.
3. Push the **Directory** bottom button.
4. Repeat step 3 until you reach the destination directory.

Push the **Up Level** side button to move a directory up by one level.

To move a directory down by one level, select the directory from the file listing on the screen, and then push the **Down Level** side button.

Making Directory Do the following steps to create a new directory:

1. Push the **EDIT** button.
2. Select a drive and/or directory.
3. Push **Directory** (bottom)→**Make Directory** (side).

The Input Filename dialog box appears.

4. Use the Input Filename dialog box to specify the new directory name and/or destination.

Selecting Files Do the following steps to select a file:

1. Push the **EDIT** button.
2. Select a file from the file listing on the screen using the ▲ or ▼ buttons or the general purpose knob.

Copying Files Do the following steps to copy a file:

Copy with Double Windows.

1. Push **Edit** (front-panel). Select the file you want to copy.
2. Push **Window** (bottom) → **Window** (side) and select **Double**. Two windows listing file names are displayed.
3. Push **Select** (side) button to toggle an active window.
4. Push **Directory** (bottom). If necessary, push **Up Level**, **Down Level** or **Make Directory** (side) buttons to move the directory.

5. Push **Select** (side) button to make the window listing the file to be copied active. Make sure that the file to be copied is selected.
6. Push the **File** (bottom) → **Copy** (side) side buttons. A copied file is displayed in the directory you specified in step 4.

When the file with the same file name exists in the destination, a message *Overwrite existing file?* appears.

Copy with Single Windows.

1. Push **Edit** (front-panel). Select the file you want to copy.
2. Push **File** (bottom) → **Copy** (side). The Input Filename dialog box is displayed. Specify the file name and destination directory.
3. Push **OK** (side) button. The file is copied to the directory you specified in step 2.

Moving Files

To move files, use double windows. Do the following steps.

1. Push **Edit** (front-panel). Select the file you want to move.
2. Push **Window** (bottom) → **Window** (side) and select **Double**. Two windows listing file names are displayed.
3. Push **Select** (side) button to toggle an active window.
4. Push **Directory** (bottom) and, if necessary, push **Up Level**, **Down Level** or **Make Directory** (side) buttons to move the directory.
5. Push **Select** (side) button to make the window listing the file to be moved active. Make sure that the file to be moved is selected.
6. Push the **File** (bottom) → **Move** (side) side buttons. A file is moved in the directory you specified in step 4.

When the file with the same file name exists in the destination, a message *Overwrite existing file?* appears.

You can also perform the 'move' operation with single window by using **Copy** and **Delete** commands.

Renaming Files

Do the following steps to rename a file:

1. Select a file or directory to rename.
2. Push the **Rename** side button.
The Input Filename dialog box appears.
3. Use the Input Filename dialog box to specify the new file name and the destination.
4. Push **OK** (side) button. The file is renamed to the directory you specified in step 3.

Deleting One or All Files

Delete removes the selected file. **Delete All** removes all files and empties directories contained in the current directory. These commands do not delete any directories that contain files. When you delete files or directories, the instrument displays a dialog box asking you to confirm the file/directory deletion. Do the following steps to delete one or more files and/or empty directories:

1. Select a file or directory to delete.
2. Push the **Delete** or **Delete All** side button.
3. Push **OK** or **Cancel** (side), depending on the message to confirm deletion.

Assigning Attribute to Files

Attribute prevents a file or directory from unconditional modifications or deletion. This is made by assigning the Read Only or Read/Write attribute to the file. After you assign the Read Only attribute to the file, a key mark appears on the left of the file listing.

1. Select a file to which you want to assign or change an attribute status. All files are assigned read/write status by default.
2. Push the **Attribute** side button to toggle between Read/Write and Read Only, as necessary.

File Operation in Double Windows

When the Window bottom button is displayed, you can divide the file list in the Edit Screen into two windows as shown in Figure 3-73. This function is called Double Windows.



Figure 3-73: Double Windows

In Double Windows, for example, you can display the file list of the hard disk and the one of the floppy disk, or the file list of a directory and the one of an another directory. All of the functions that are invoked from the bottom buttons are available except for the File function.

The most important functions used in two file lists displayed at the same time are the Copy and Move file operations.

Window Operation

The windows are named as Upper and Lower windows as indicated in Figure 3-73. Select a window for operation.

Push **EDIT** (front) → **Window** (bottom) to display the Window side button. Push the **Window** side button again to select Double for double windows. Push the **Window** side button again to select Single and to return the display back into the signal file list.

When you display the double windows, the **Select** side button will be available. Push the **Select** side button to select Upper for file operation in the upper file list window. Push the **Select** side button again to select Lower for file operation in the lower file list window.

Operation in Double Windows

The most useful functions to be used in the double windows may be those invoked from the File bottom button. The functions available in the File bottom button are described in Table 3-52.

Table 3-52: File operation in double windows

Operation	Description
Copy	Copies a file from a selected file list window into the destination specified in the other file list window. You cannot select the directory.
Copy All	Copies all files in a selected file list window into the destination specified in the other file list window. You cannot copy the directory or directory structure.
Move	Moves a file selected in a selected file list window into the destination specified in the other file list window. You cannot select the directory.
Move All	Moves all files in a selected file list window into the destination specified in the other file list window. You cannot move the directory or directory structure.

NOTE. You cannot use the *Rename, Delete, Delete All, and Attribute* side buttons unless you display the single file list window.

In copy or move operation, when the files with the same file name exist in the destination, the message *Overwrite existing file?* appears. At the same time, the **Cancel, No, Yes to All,** and **Yes** side buttons appear. Press any of these side buttons to proceed.

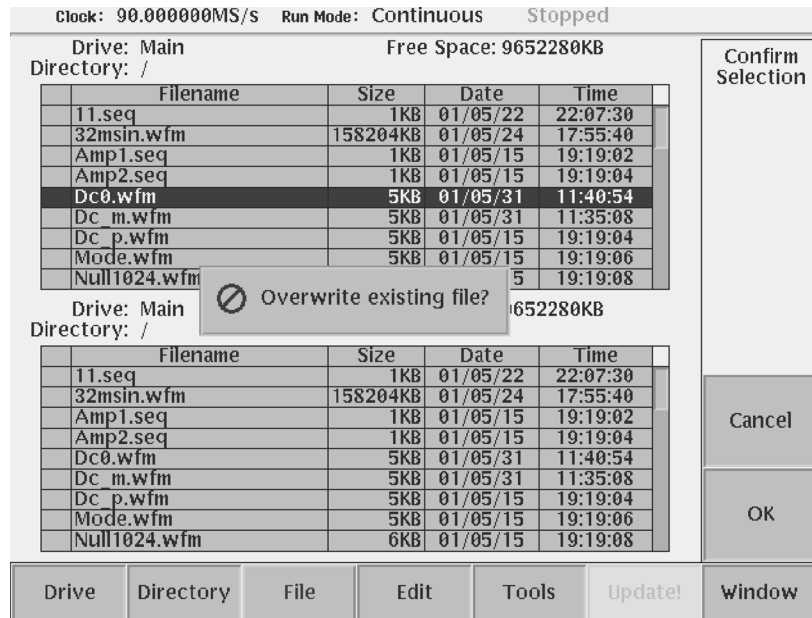

Figure 3-74: Overwrite confirmation

Table 3-53: Confirmation selection for copy–all and move–all operations

Side menu	Description
Cancel	Cancels and stops copy or move operation.
No	Skips the copy or move operation for the file indicated in the message.
Yes to All	Overwrites all the files without displaying any messages until the operation is finished.
Yes	Overwrites the file indicated in the message and proceeds with the operation.

You cannot copy or move a directory. In the copy–all or move–all operation, the message *Directory cannot be copied* appears when you are trying to move or copy a directory. Press the **OK** side button to confirm and proceed with the operation.

FG Mode

The AWG710&AWG710B Arbitrary Waveform Generator provides the Function Generator (FG) mode to output standard function waveform. This section describes the FG mode. The product which has option 02 doesn't have offset function.

FG mode Signals are created and output using the following process:

- Select the waveform type.
- Set the output parameters such as frequency and amplitude.
- Turn the OUTPUT button to ON.

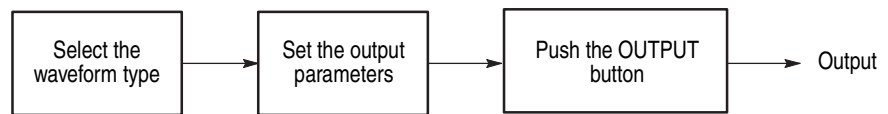

Figure 3-75: Outline flow for producing Function Generator signal

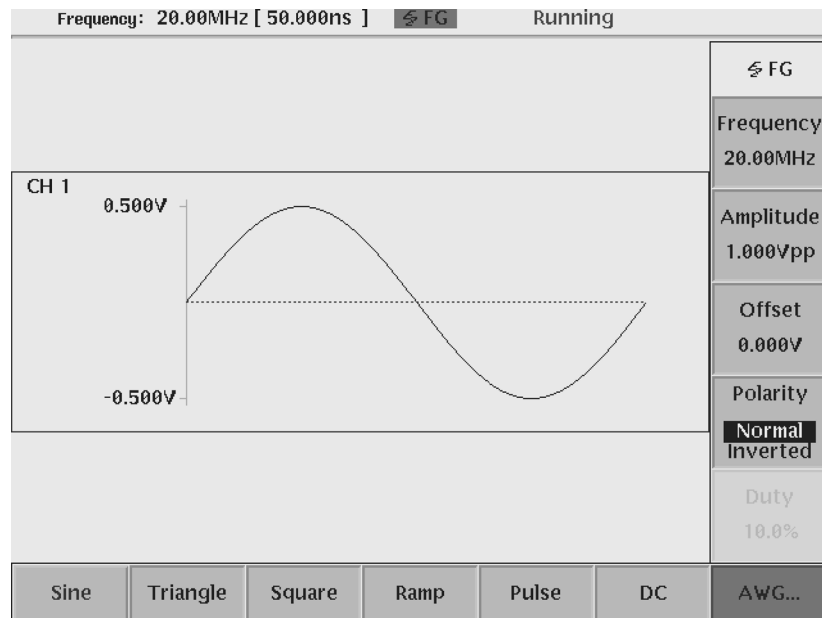

Figure 3-76: FG mode screen (except option 02)

Change the generator mode

AWG mode to FG mode The instrument initializes in the AWG mode when powered on.

Do the following to change the generator mode from AWG to FG:

1. Push **SETUP** (front-panel)→**Extended Operation** (bottom)→**Ez FG...** (side) button.

The instrument displays the FG mode screen.

FG mode to AWG mode Do the following to change the generator mode from FG to AWG:

1. Push **Exit Ez FG...** (bottom) button.

The instrument returns to the AWG mode.

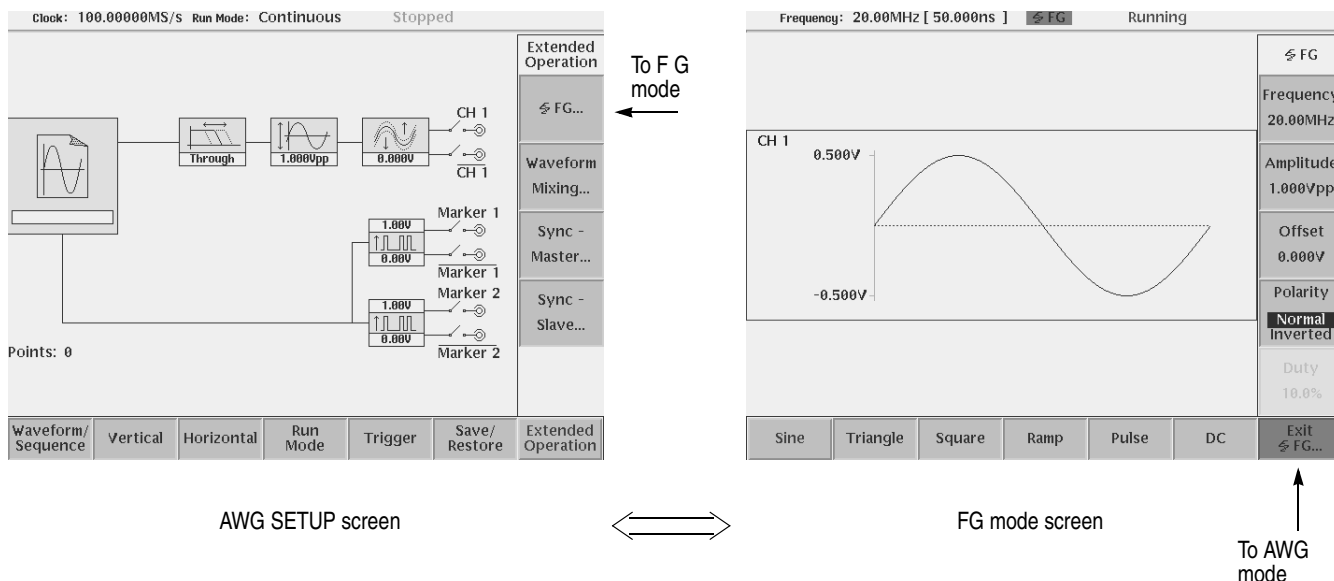

Figure 3-77: Change the generator mode (except option 02)

NOTE. All the parameters on the FG mode menu are independent of the AWG mode parameters. Therefore, the output parameters, such as frequency, amplitude and offset, have no effect on the parameters set with the SETUP menu while in the other mode.

In FG mode, the AWG710&AWG710B runs CONTINUOUS mode only.

Waveform type

Select the Waveform type

You can select Sine, Triangle, Square, Ramp, Pulse and DC waveform.

1. Push **Sine**, **Triangle**, **Square**, **Ramp**, **Pulse** or **DC** (bottom) button to select the desired waveform type.

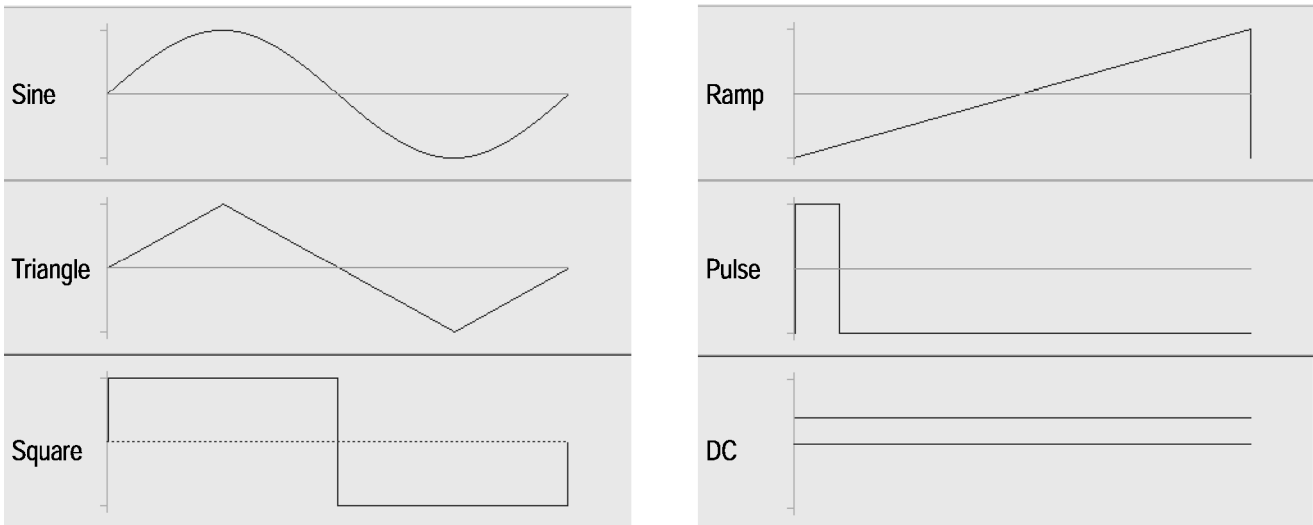

Figure 3-78: Waveform type

Parameters

Output parameters

The output parameter menu selections are the same for each waveform except Pulse and DC. Pulse has one extra side menu item (Duty), and DC has only one side menu item (Offset). In the case of option 02, output level is fixed in 0V in the DC function.

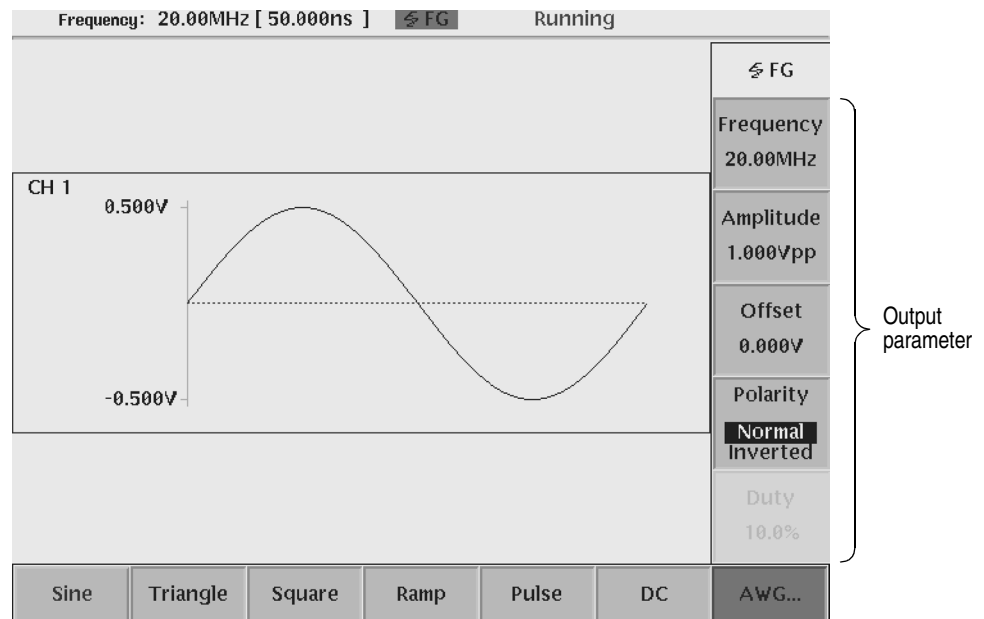

Figure 3-79: Output parameters (except option 02)

Frequency

The frequency is set with a 4-digit number from 1.000 Hz to 400.0 MHz using the SAMPLE RATE / SCALE knob, the numeric buttons or the general purpose knob.

The internal cut-off filter used is determined by the waveform type and the frequency selected. The cut-off frequencies are as follows; (except option02)

Table 3-54: Output frequency and filter cut-off frequency (except option02)

Waveform type	Output Frequency	Filter Cut-off Frequency
Sine	1.000 Hz to 400.0 kHz	20 MHz
	400.1 KHz to 4.000 MHz	50 MHz
	4.001 MHz to 8.000 MHz	100 MHz
	8.001 MHz to 15.00 MHz	200 MHz

Amplitude

The amplitude output voltage range is from 0.020 V_{p-p} to 2.000 V_{p-p} (Option 02: 0.500 V_{p-p} to 1.000 V_{p-p}), in 1 mV increments, terminated into a 50 Ω load. Set the waveform amplitude using the LEVEL / SCALE knob, the numeric buttons or the general purpose knob.

Offset (except option 02)

The offset range is from -0.500 V to +0.500 V, in 1 mV increments. Use the VERTICAL OFFSET knob, the numeric buttons or the general purpose knob to set the waveform offset level.

Offset is also used for setup of DC level.

Polarity

This menu sets the output waveform polarity. Pushing the Polarity menu button toggles polarity between Normal and Inverted.

Duty

When you select Pulse waveform, Duty... side menu is added. The Duty cycle is set from 0.1% to 99.9% using the numeric buttons or the general purpose knob. Increment step size depends on the output frequency. Refer to Table 3-56 on page 3-239.

Marker signal Marker1 and Marker2 signals are generated and output from MARKER OUT1, MARKER OUT1, MARKER OUT2 and MARKER OUT2 connectors. The waveform marker signal has the same form as a pulse waveform. The level and width of the markers are fixed and cannot be changed. Table 3-55 describes the marker specification. Marker width depends on the output frequency. Refer to Table 3-56 on page 3-239.

Table 3-55: Predefined Marker signal

Waveform	Hi	Low	Level
Marker1	0 (phase = 0 deg.) to 20 % of one period of waveform	20 to 100 % of one period of waveform	Hi : 2.0 V :AWG710 1.0 V :AWG710B Low : 0.0V
Marker2	0 (phase = 0 deg.) to 50 % of one period of waveform Frequency: 100.1MHz to 160.0MHz 0 (phase = 0 deg.) to 52 % of one period of waveform	50 to 100 % of one period of waveform 52 to 100 % of one period of waveform	Hi : 2.0 V :AWG710 1.0 V :AWG710B Low : 0.0V

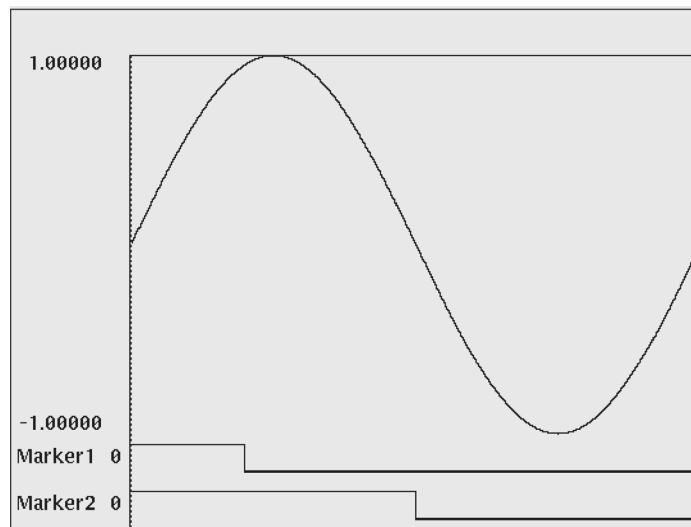

Figure 3-80: Marker pattern

Frequency and Resolution

While operating in FG mode, the output frequency determines the number of data points used to generate the waveform data and the marker data for one period. The resolution of Pulse Duty cycle ratio and the width of Marker position corresponding to the number of data points are shown in the following table.

Table 3-56: Output Frequency and Waveform Length

Frequency	Number of Data Points	Duty Ratio Resolution (%)	Marker1 position ¹	Marker2 position ²
1.000Hz to 400.0kHz	10000	0.1	2000	5000
400.1kHz to 4.000MHz	1000	0.1	200	500
4.001MHz to 20.00MHz	200	0.5	40	100
20.01MHz to 40.00MHz	100	1	20	50
40.01MHz to 80.0MHz	50	2	10	25
80.01MHz to 100.0MHz	40	2.5	8	20
100.1MHz to 160.0MHz	25	4	5	13 ³
160.01MHz to 200.0MHz	20	5	4	10
200.01MHz to 400.0MHz	10	10	2	5

- 1: 20% position of 1 waveform period
- 2: 50% position of 1 waveform period
- 3: 52% position of 1 waveform period because of number of data points.

Save/Restore Setup

You can save and restore the instrument output setup information on FG mode to a setup file. Setup file includes waveform type, marker signals and all the output setup parameters. Save/Restore operation is executed on the Save/Restore menu of the SETUP screen in AWG mode. A saved setup file contains the setting information on both AWG mode and each Extended Operation mode. Refer to The Save/Restore Menu on page 3-48.

Operation Flow

When the AWG710&AWG710B is in AWG mode, change to FG mode. Reference page 3-234.

1. Push **Sine, Triangle, Square, Ramp, Pulse** or **DC** (bottom) button to select the waveform.
2. Set the output parameters according to the waveform selected.
 - Duty is added to the side menu for Pulse mode.
 - Offset is only used for setup of DC level. Offset is selected on the DC side menu.

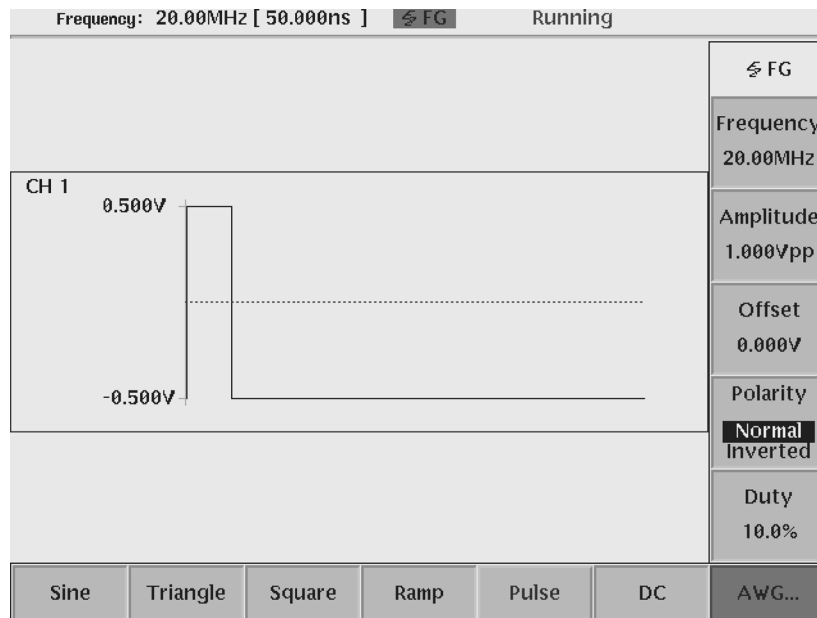

Figure 3-81: Pulse sub-side menu (except option 02)

3. Push the **RUN** (front) button to turn on the RUN LED. Usually, when it switches to FG mode from AWG mode, it automatically changes to the run state (the RUN LED is on).
4. Push the **CH1 OUT** button and **ALL MARKER OUT ON/OFF** button to output the signal that the corresponding output connector.

Waveform Mixing Mode

The AWG710&AWG710B Arbitrary Waveform Generator provides the Waveform Mixing mode to create and output a mixed waveform. Waveform mixing generates the waveform which added the value for every point of two waveforms, A and B, at a rate of a mixing ratio.

Mixed signals are created and output using the following process:

- Select two waveform files to mix.
- Set the parameters about waveform mixing such as a mixing ratio, waveform length, etc.
- Set the output parameters such as frequency and amplitude.
- Turn the OUTPUT and ALL MARKER OUT ON/OFF buttons to ON.

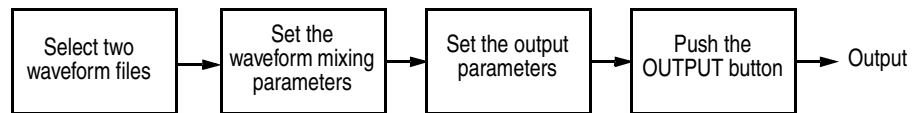

Figure 3-82: Outline flow for producing Mixed signal

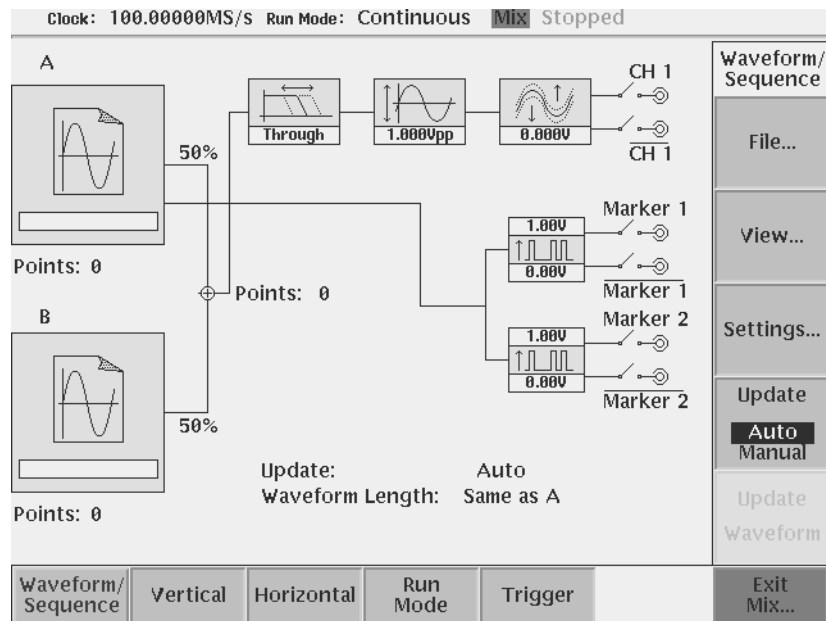

Figure 3-83: Waveform Mixing mode screen

Change the generator mode

AWG mode to Waveform Mixing mode

The instrument initializes in the AWG mode when powered on.

Do the following to change the generator mode from AWG to Waveform Mixing:

1. Push **SETUP** (front-panel)→**Extended Operation** (bottom)→**Waveform Mixing...** (side) button.

The instrument displays the Waveform Mixing mode screen.

Waveform Mixing mode to AWG mode

Do the following to change the generator mode from Waveform Mixing to AWG:

1. Push **Exit Mix...** (bottom) button.

The instrument returns to the AWG mode.

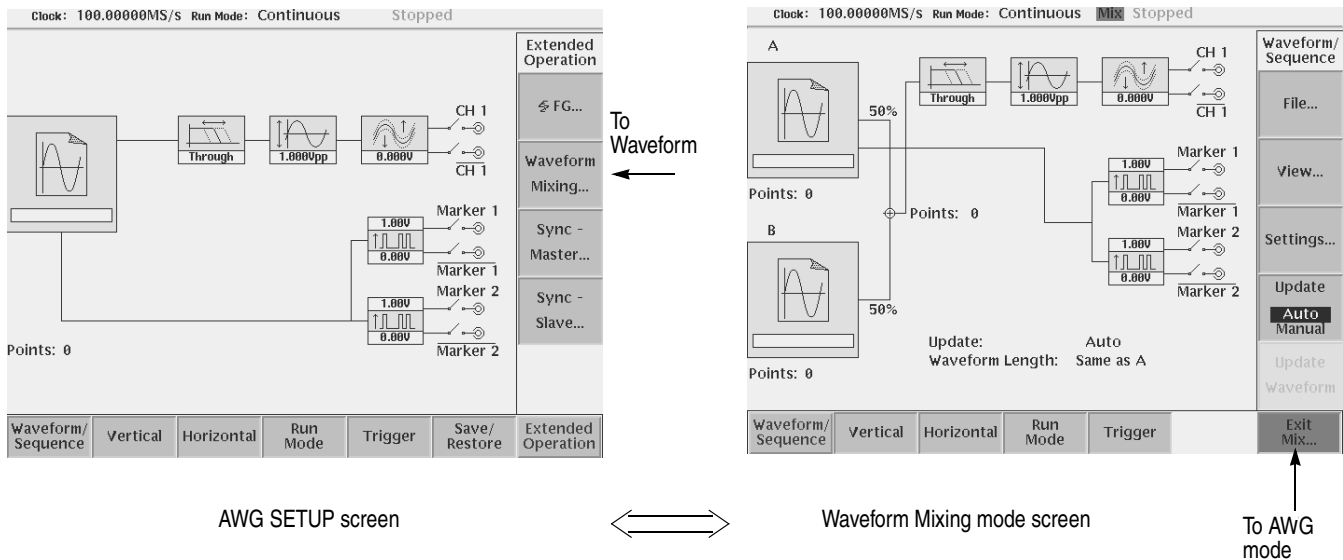

Figure 3-84: Change the generator mode

All bottom menus except the Waveform/Sequence menu are same as AWG mode, and the setting value of each parameter is also common.

NOTE. When the instrument runs in Waveform Mixing mode, you cannot use Synchronous Operation mode or FG mode.

File... menu

Load A File... Load B File...

Select two files, waveform A and waveform B, to mix. When the instrument enters Waveform Mixing mode, the waveform loaded in AWG mode is selected as Waveform A. Loading of the file in AWG mode sets data to the waveform memory for a waveform output. On the other hand, loading of the file in Waveform Mixing mode sets data to the work area for waveform mixing.

Please care about the following point, in case you select a waveform.

- A waveform file (*.wfm), a pattern file (*.pat), or a sequence file (*.seq) can be specified to be Waveform A and B. However, the sequence file containing a sub sequence cannot be specified.
- A pattern file and a pattern file included in the sequence file are treated as a waveform file. A eight bit pattern of each point is treated as the real number of the value of the range of -1 to +1.
- Although the combination of a waveform file and a pattern file is free, only combination with a sequence file is possible for a sequence file. If the illegal file type is specified, the file of another side will become blank.

Table 3-57: Combination of the file type

Waveform A	Waveform B	Descriptions
*.wfm or *.pat	*.wfm or *.pat	A pattern file is treated as a waveform file.
*.seq	*.seq	The number of lines needs to be the same. The sequence containing a sub sequence cannot be specified. As for a sequence control parameter, the value of the sequence file of Waveform A is used.

- Although the numbers of points of Waveform A and Waveform B may differ, the number of lines of a sequence file must be the same.
- The sequence control parameters (Repeat Count, Wait Trigger, Go to <N>, Logic Jump) of a sequence file of Waveform A become effective.
- Coincidence of the number of lines and the check of the number restrictions of points are performed at the time of loading of a file. It cannot load, when not meet conditions.
- The waveform file contains the clock rate value. When a file is loaded to Waveform A and B, the clock rate value of Waveform A is set as a clock rate value of AWG.

- The file loaded to Waveforms A and B cannot be edited on the Edit screen.

Do the following steps to load a file:

1. Push **Waveform/Sequence** (bottom)→**File...** (side)→**Load A File...** or **Load B File...** (side)
2. Select a waveform file, pattern file or sequence from the file listing in the Select File dialog box that appears on the screen.
3. Push the **OK** side button.

Save Mixed Wfm... menu

A mixed result can be saved as waveform data (*.wfm). The information saved is the data and the clock rate of a mixed waveform.

The mixed waveform of the combination of a waveform file (*.wfm) and a pattern file (*.pat) is saved as a waveform file (*.wfm). The mixed waveform of the combination of a sequence file (*.seq) cannot be saved.

Not the value of present clock rate but the value included in the file by which it loaded to Waveform A is written in as a clock rate of a mixed waveform.

The mixed waveform saved is a waveform which it is loaded to a waveform memory and outputted now. When Manual is selected by Update menu, a saved waveform and a waveform based on a current setup of a SETUP screen may differ from each other. By pushing the Update Waveform button, each waveform will become the same. Refer to the Update on page 3-246

When you display a mixed waveform on the screen, save it as a waveform file and open it on the waveform editor.

Do the following steps to save a mixed waveform:

1. Push **Waveform/Sequence** (bottom)→**File...** (side)→**Save Mixed Wfm As...** (side)

Save Mixed Wfm As... button becomes effective when Waveforms A and B have been loaded.

2. An Input Filename dialog box is displayed. Specify a file name and a preservation directory and push the **OK** button.

Select a waveform file, pattern file or sequence from the file listing in the Select File dialog box that appears on the screen.

View... menu

While handling a file, you sometimes want to look at the content of a file to confirm the operation. View menu displays the view window and allows you to view a

waveform or pattern file loaded in a waveform A or a waveform B. You cannot view files other than waveform or pattern in this function. When you display a mixed waveform on the screen, save it as a waveform file and open it on the waveform editor.

Do the following steps to display a loaded file:

1. Push **Waveform/Sequence** (bottom)→**View...** (side)→**View A** or **View B...** (side)

Waveform Mixing parameters

A mixed waveform is generated by the following formula to two specified waveforms.

$$\text{Mixed.wfm} = \text{A.wfm} * \text{Ratio of A} + \text{B.wfm} * \text{Ratio of B}$$

Ratio of A... Ratio of B...

The ratio of Waveforms A and B is specified with a Ratio of A and Ratio of B button. The range of these parameters is as follows:

$$0 \leq \text{Ratio of A} (\%) + \text{Ratio of B} (\%) \leq 100 (\%)$$

1. Push **Waveform/Sequence** (bottom)→**Setting...** (side)→**Ratio of A** or **Ratio of B** (side)
2. Use the general purpose knob, numeric buttons, or keyboard to change the ratio of Waveform A and B.

Marker

This button lets you select which marker of Waveforms A or B is used as a marker of a mixed waveform. The marker of the selected waveform is applied repeatedly and let it be the marker of a mixed waveform until it fills the waveform length of a mixed waveform.

1. Push **Waveform/Sequence** (bottom)→**Setting...** (side)→**Marker** (side)
2. Push the Marker side button to toggle between Same as A and Same as B.

Wfm Len

This button lets you specify the length of a mixed waveform. It is specified from the following:

- **Same as A:** The number of points of a mixed waveform is made the same as the number of points of Waveform A. When the number of points of Waveform

B is small, it repeats until it becomes the number of points of a mixed waveform.

- **Same as B:** The number of points of a mixed waveform is made the same as the number of points of Waveform B. When the number of points of Waveform A is small, it repeats until it becomes the number of points of a mixed waveform.
 - **LCM(A,B):** The number of points of a mixed waveform is made into the least common multiple of the number of points of two waveforms.
1. Push **Waveform/Sequence** (bottom)→**Setting...** (side)→**Wfm Len**(side)
 2. Use the general purpose knob or Wfm Len menu button to select the length of a mixed waveform.

Update

Loading of the file in AWG mode sets data to the waveform memory for a waveform output. On the other hand, loading of the file in Waveform Mixing mode sets data to the work area for waveform mixing. When data is set to Waveform A and Waveform B, preparation of waveform mixing will be completed. Based on parameters of waveform mixing, a mixed waveform is generated in a work area, and a mixed waveform is outputted in loading to a waveform memory.

With the Update button, you can specify the timing which generates a mixed waveform and is loaded to a waveform memory.

- **Auto:** When the file of Waveforms A or B is changed, or when a waveform mixing parameter is changed, a mixed waveform is regenerated and waveform data is loaded to a waveform memory.
- **Manual:** When the Update Waveform button (it will become effective if Manual is selected) is pushed, a mixed waveform data is regenerated and it is loaded to a waveform memory.

It takes much time in order to generate a large mixed waveform. By choosing Manual, it can prevent regenerating a mixed waveform at every parameter change.

1. Push **Waveform/Sequence** (bottom)→**Update** (side)
2. Push the **Update** side button to toggle between Auto and Manual.

When Manual is selected, the Update Waveform side button becomes effective.

Save/Restore Setup

You can save and restore the instrument output setup parameters. The setup parameters on Extended Operation modes are saved together with the setting information on AWG mode at a setting file.

Save/Restore operation is executed on the Save/Restore menu of the SETUP screen in AWG mode. A saved setup file contains the setting information on both AWG mode and each Extended Operation mode. Refer to The Save/Restore Menu on page 3-48.

Operation Flow

When the AWG710&AWG710B is in AWG mode, change to Waveform Mixing mode. Reference page 3-242.

1. Push **Waveform/Sequence** (bottomless... (side)→**Load A File...** or **Load B File...** (side)
2. Push **Previous Menu** (side) to back to the Waveform/Sequence side menu.
3. Push **Update** (side) to select the Update mode.
Usually, select Auto. When generating a large mixed waveform, select Manual.
4. Push **Setting...** (side) to specify the waveform mixing parameters.
 - **Ratio of A, Ratio of B:** Specify the ratio of Waveforms A and Waveform B.
 - **Marker:** Specify which marker is used as a marker of a mixed waveform.
 - **Wfm Len:** Specify the length of the mixed waveform.
5. When Manual is selected in the Update menu, mixed waveform is updated when **Update Waveform** (side) button is pushed.
6. When Manual is chosen in Update mode, change of a parameter will be reflected if Update Waveform is pushed.
7. Set each item of Vertical, Horizontal, Run Mode, and the Trigger menu like the time of AWG mode.
8. Set each parameter of the Vertical, Horizontal, Run Mode, and Trigger menu is set up like the time of the usual AWG mode.
9. Push the **RUN** (front) button to turn on the RUN LED.
10. Push the **CH1 OUT** button and **ALL MARKER OUT ON/OFF** button to output the signal that the corresponding output connector.

Synchronous Operation Mode (AWG710B only)

Synchronous Operation is a feature that allows you to use two channels of signal by operating two AWG710B. A word synchronous called here means that two units of the AWG710B operate with the same clock and that start and stop of output signals of two units are corresponding.

A unit that controls the overall system is called Master, and a unit that is used for an additional channel is called Slave. In the Synchronous Operation mode, the master and slave should be connected directly for the Clock and Trigger signals, because the timing is critical. For other signals, the master controls the slave through a LAN. Although loading of a waveform file and the setting parameter of the Vertical menu are performed to Master and Slave each, control of other Slave is performed from Master via LAN.

The remote command via LAN can be used also during synchronous operation.

Two units of synchronous operations are performed as follows:

- Connect two LAN cables, four Clock signal cables and four Trigger signal cables.
- One unit is set as Slave and one more unit is set as Master.
- Connect the Master and the Slave via LAN.
- Load the waveform files to the Master and the Slave.
- Set the output parameters such as frequency and amplitude
- Master and Slave are connected via LAN.
- Turn the OUTPUT and ALL MARKER OUT ON/OFF buttons to ON.

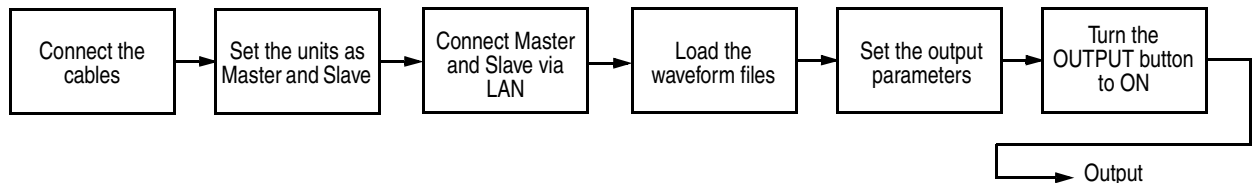

Figure 3-85: Outline flow for producing Synchronous operation

restrictions

There are the following restrictions in synchronous operation mode operation.

- The same model and the same firmware version should be used for Synchronous Operation.
- When the instruments run in Synchronous Operation mode, you cannot use FG mode or Waveform Mixing mode.
- The Gated mode in Run mode cannot be used. An event jump cannot be used although Enhanced mode can be used.
- Waveform length needs to be in agreement Although waveforms may differ in the waveform file loaded to Master and Slave, the number of points of waveform files must be the same.
- The sequence files loaded to Master and Slave needs to be completely the same. However, the waveforms specified to be each sequence line may differ, as long as the waveform length is the same.
- The file loaded to the waveform memory cannot be edited or Quick edited.
- Another waveform file cannot be loaded during output operation (RUN LED under lighting).

Connecting the cables

LAN cable In Synchronous Operation mode, the Master control the Slave through a LAN. Master and Slave are connected to a network using a LAN cable. You need to connect the LAN cables before you power on the instruments.

Cables for Clock and Trigger To synchronize the clock and jump timing on the overall system, connect the two types of signals, Sync Clock and Sync Trigger. It is necessary to supply the same signals to Master and Slave from Master. The cable to be used must conform to the requirements of length and characteristics. Use the specified 50 cm 50 Ω SMA cable (P/N: 174-1427-00 made by Tektronix).

Connect the eight SMA cables as shown in Figure 3-86 on page 3-251 . The label C of a connection figure expresses the clock and T expresses the trigger signal.

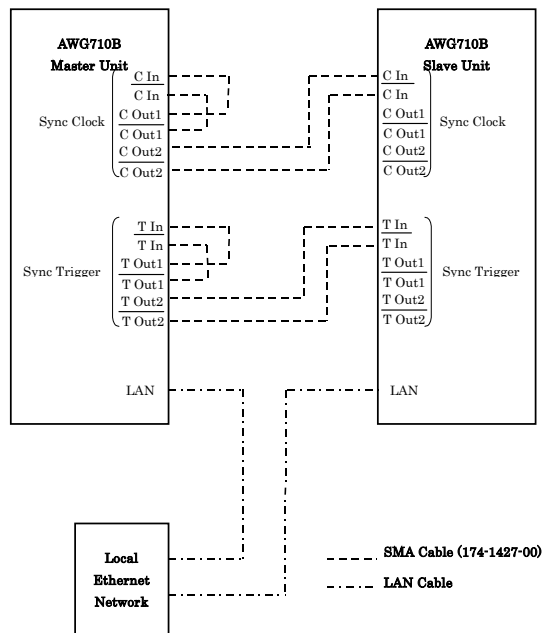

Figure 3-86: Synchronous Operation cable connection

Change the generator mode

AWG mode to Synchronous Operation mode

The instrument initializes in the AWG mode when powered on.

Do the following to change the generator mode from AWG to Synchronous Operation:

1. Push **SETUP** (front-panel) → **Extended Operation** (bottom) → **Sync - Master...** or **Sync - Slave...** (side) button.

The instrument displays the Synchronous Operation mode screen.

Synchronous Operation mode to AWG mode

Do the following to change the generator mode from Synchronous Operation to AWG:

1. Push **Exit Sync...** (bottom) button.

The instrument returns to the AWG mode.

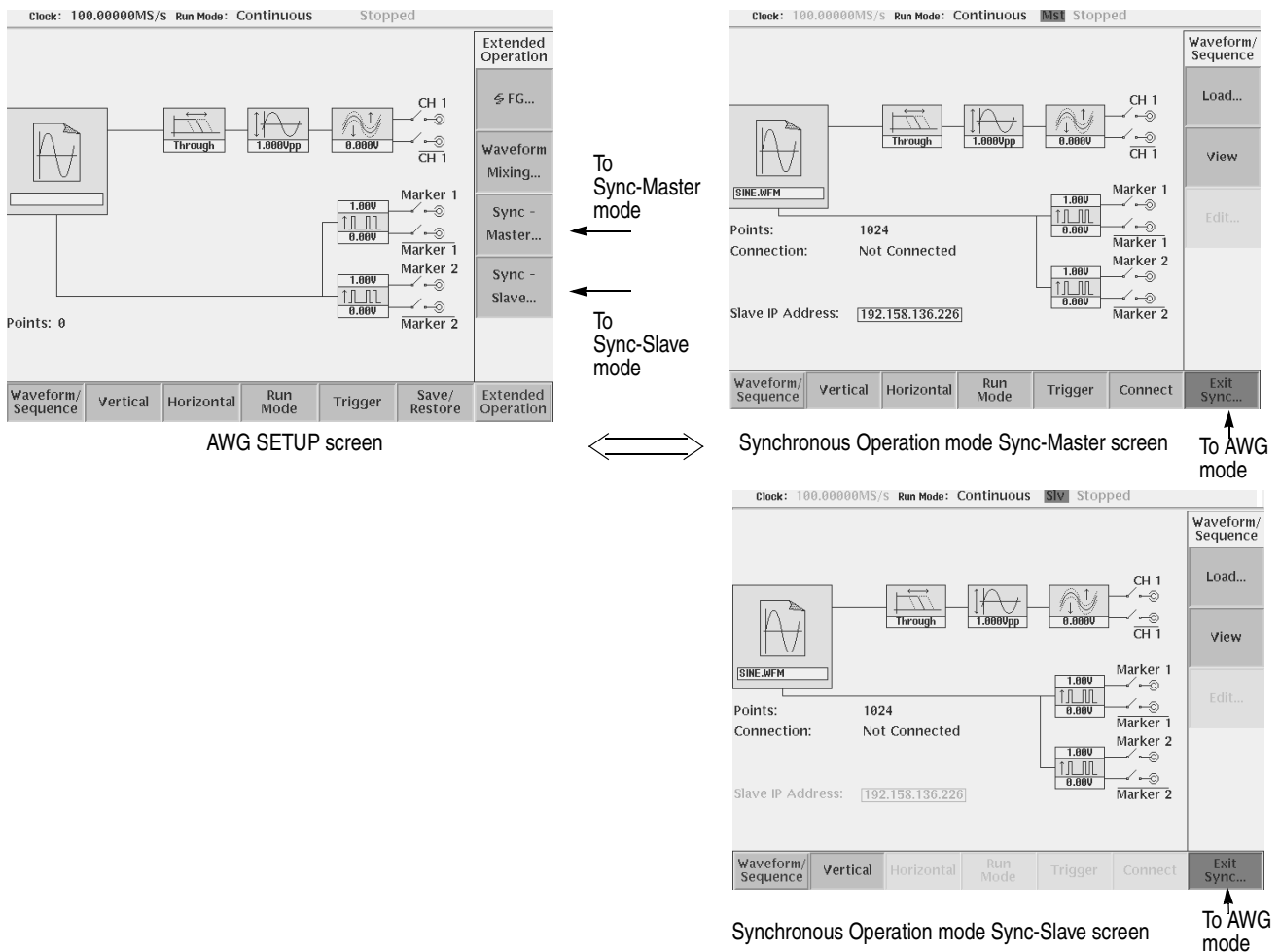
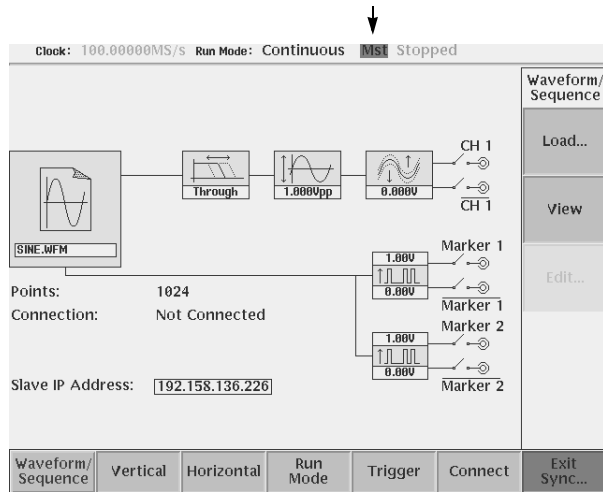
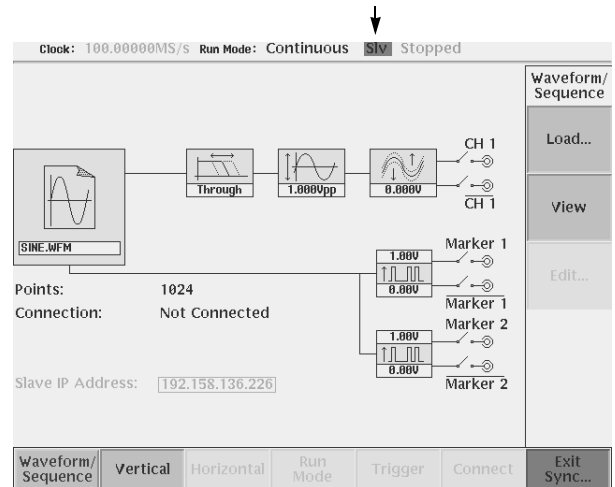

Figure 3-87: Change the generator mode

Setup screen



Synchronous Operation mode Sync-Master screen



Synchronous Operation mode Sync-Slave screen

Figure 3-88: Synchronous Operation mode screen

- **Status area:** Mst or Slv mark is displayed and it indicates that the instrument is Synchronous Operation mode.
- **Connection:** The connection state of Master and Slave is displayed. When connecting, the IP address of a partner's unit is displayed. When not connecting, it is displayed as Not Connected.
- **Slave IP Address:** The IP address of Slave set by Master is displayed.

Vertical, Horizontal, Run Mode, and the Trigger menu of the SETUP screen in Sync-Master mode are as same as AWG mode, and the same setting value is used. The Connect bottom menu performs a setup about synchronous operation.

On the SETUP screen in Sync-Slave mode, only Waveform/Sequence and the Vertical menu are effective. The setting item of Horizontal, Run Mode, and Trigger menu is controlled from Master.

Table 3-58: Difference between AWG mode and synchronous operation mode

Bottom menu	Sync-Master	Sync-Slave
Waveform /Sequence	Another waveform file cannot be loaded during output operation (RUN LED under lighting). The loaded file cannot be edited.	Another waveform file cannot be loaded during output operation (RUN LED under lighting). The loaded file cannot be edited.
Vertical		
Horizontal		It controls by Master.
Run Mode	Gated mode cannot be used.	It controls by Master.
Trigger		It controls by Master.

Setting a Slave IP address

The IP address of Slave is registered into Master with the **Edit Slave IP Address** menu.

1. Push **UTILITY** (front-panel)→**Comm** (bottom) button of the AWG710B used as slave
2. Check and write the IP address of slave.
3. Push **Connect** (bottom)→**Edit Slave IP Address...**(side) button of the master AWG710B.
4. The Slave IP Address dialog box appears. Enter the IP address of the slave AWG710B.
5. Push the **OK** side button.

Testing the Network Connection

Complete the physical connection and settings, using the **Execute Ping...** menu verify that the slave AWG710B can be recognized correctly. The usage is the same as Execute Ping of the Comm bottom menu of a **UTILITY** screen. Refer to the Testing the Network Connection on page 3-164 .

Connection with Slave

Connection and disconnection with Slave are performed by Master using the **Connect to Slave** and **Disconnect** menu.

1. Push **SETUP** (front-panel)→**Connect**(bottom) →**Connect to Slave** (side) button to connect to the slave AWG710B.
2. Push **SETUP** (front-panel)→**Connect**(bottom) →**Disconnect** (side) button to disconnect to the slave AWG710B.

In the following cases, the connection between Master and Slave is canceled automatically.

- The LAN cable is unplugged from the connector.
- The power of Slave was turned off.
- Master or Slave was changed from Synchronous Operation mode.
- When executing Diagnostic or Calibration of the UTILITY menu.

Error messages on connection

When making connection with Slave in Synchronous Operation mode, the AWG710B is also performing Trigger Timing CAL automatically.

The following error/warning messages may be displayed during operation in Synchronous Operation mode.

Table 3-59: Error/Warning messages

Message	Description
Gated is not available in Synchronous Operation.Run Mode will be changed to Continuous.	It is the warning message which comes out when it is going to go into Sync-Master, where Gated is specified by Run Mode. Ruined switches to Continuous.
External Clock Source or External Clock Reference is not available in Synchronous Operation - Slave. Clock Source and Clock Reference will be changed to Internal	It is the warning message which comes out when it is going to go into Sync-Slave, where External is specified by ClockSource or by ClockReference. As for the Slave itself, Clock and Reference Clock operate in the state of Internal.
Connection will be lost.	It is displayed, when connection between Master and Slave is established and it is going to perform Calibration/Diagnostics of the UTILITY menu.

Table 3-59: Error/Warning messages (cont.)

Message	Description
<p>Connection \failed. Verify the instrument settings:</p> <ul style="list-style-type: none"> - Network cable is properly connected. -Slave IP Address entered correctly. -Slave unit is configured as Sync-Slave. <p>If the problem still exists, power the instrument off and then back on, for Master and Slave.</p>	<p>It is displayed when connection with Slave is not made normally. The following cause can be considered.</p> <ul style="list-style-type: none"> ■ It was going to connect with an instrument other than AWG710B. ■ An instrument which it is going to connect is not Sync-Slave mode. ■ Although the AWG710B which it is going to connect is Sync-Slave mode, it has already connected with other AWG710B. ■ The IP address of slave instrument is incorrect. ■ Slave AWG710B has not started yet. ■ The LAN cable is not connected. ■ The LAN cable was connected after the AWG710B was powered on.
Synchronous Operation is not supported between different models of AWG.	It is displayed when it is going to connect with an instrument other than AWG710B.
Trigger Timing Calibration failed.(Master) / (Slave) Check SMA cable connections.	It is the error which takes place at the time of a connection start with Slave, or a Trigger Timing CAL start. It is displayed when the SMA cable of Master or Slave is not connected correctly.
Trigger Timing Calibration failed. (Communication)	It is displayed when communication with slave cannot be taken with network obstacles (the cable unplugged) during calibration execution.

Trigger Timing Calibration

This calibration makes the skew to a trigger signal regularity. When making connection between Master and Slave, AWG710B is always performing this calibration automatically. When temperature change arises while in use, it can perform if needed. It can perform only where connection with Slave is established.

1. Connect the LAN cables and SMA cables.
2. Power the two AWG710B on, and set the each AWG710B as Master and Slave.
3. Push **Connect** (bottom) → **Connect to Slave** (side) button to establish connection with Slave. The **Execute Trigger Timing Calibration** (side) button will become effective if connection is established.
4. Push **Connect** (bottom) → **Execute Trigger Timing Calibration** (side) button to execute the trigger timing calibration.

Save/Restore Setup

You can save and restore the instrument output setup parameters. The setup parameters on Extended Operation modes are saved together with the setting information on AWG mode at a setting file.

Save/Restore operation is executed on the Save/Restore menu of the SETUP screen in AWG mode. A saved setup file contains the setting information on both AWG mode and each Extended Operation mode. Refer to The Save/Restore Menu on page 3-48.

Operation Flow

Two AWG710Bs are set as Sync-Master and Sync-Slave in the following procedure, and synchronous operation is performed.

1. In the power off state, connect two LAN cables, four clock signal cables and four trigger signal cables
2. Push the front panel On/Standby switch to power on the instrument.
3. Check and write the IP address of slave
4. Push **SETUP** (front-panel)→**Extended Operation** (bottom)→**Sync - Slave...** (side) button of the slave AWG710B.
5. Push **SETUP** (front-panel)→**Extended Operation** (bottom)→**Sync - Master...** (side) button of the master AWG710B.
6. Push **Connect** (bottom)→**Edit Slave IP Address...**(side) button of the master AWG710B to register the IP address of the slave AWG710B.
7. If required, push **Execute Ping...** (side) button to check that Slave can be recognized on a network.
8. Push **Connect to Slave** (side) button to connect to the slave AWG710B.
9. Specify the files of the waveform to output and set the parameters of the Vertical menu by Master and Slave.
10. The setting parameters about outputs, such as the Horizontal menu, are performed by Master.
11. Push the **CH1 OUT** button and **ALL MARKER OUT ON/OFF** button to output the signal that the corresponding output connector.
12. Push the **RUN** (front) button of the master AWG710B to start operation.



Appendices

Appendix A: Specifications (AWG710B)

This section contains the AWG710B Arbitrary Waveform Generator specifications. All specifications are guaranteed unless labeled “typical”. Typical specifications are provided for your convenience but are not guaranteed.

Specifications that are marked with the ✓ symbol in the column Characteristics are checked in *Appendix B: Performance Verification* and the page number referenced to the corresponding performance verification procedures can be found in the column PV reference page.

The characteristics in the specifications are listed in tables that are divided into categories. In these tables, the subcategories may also appear in boldface under the column Characteristics.

Performance Conditions

The performance limits in this specification are valid with these conditions:

- The AWG710B Arbitrary Waveform Generator must have been calibrated/adjusted at an ambient temperature between +20° C and +30° C.
- The AWG710B Arbitrary Waveform Generator must be in an environment with temperature, altitude, humidity, and vibration within the operating limits described in these specifications.
- The AWG710B Arbitrary Waveform Generator must have had a warm-up period of at least 20 minutes.
- The AWG710B Arbitrary Waveform Generator must be operating at an ambient temperature between +10° C and +40° C.

Warranted characteristics are described in terms of quantifiable performance limits which are warranted.

Electrical Specification

Table A-1: Operation modes

Characteristics	Description
Continuous	Waveform is continuously output in this mode. When a sequence is defined, waveforms are sequentially or repeatedly output in the order defined by the sequence. The extended sequence functions such as trigger input, event jump, and so on are neglected in this mode.
Triggered	Waveform is output only once when a trigger event is created. A trigger signal is created by the external trigger input signal, GPIB trigger command, and/or pressing the front-panel FORCE TRIGGER button. The extended sequence functions such as trigger input, event jump, and so on are neglected in this mode.
Gated	The waveform is output in the same way as in the continuous mode only when the gate is opened. The gate is opened by the gated signal. Note that the output is made from the top of the first waveform for every gate period. The clock signal continuously outputs from the connector outside the gate period.
Enhanced	The waveforms are sequentially or repeatedly output according to the procedures defined in the sequence. All extended functions such as trigger input, event jump, and so on are effective and waveforms are controlled for output by this functions in this mode.

Table A-2: Extended Operation

Characteristics	Description
FG operation	This mode provides user-friendliness like the conventional function generator. The output waveforms are Sine, Triangle, Square, Ramp, Pulse and DC waveform. AWG710B is in AWG mode when this mode is not selected.
Waveform Mixing operation	This mode provides the function for mixing two-signals digitally.
Synchronous Master operation	This mode provides the setup for using as a Master instrument on Synchronous Operation.
Synchronous Slave operation	This mode provides the setup for using as a Slave instrument on Synchronous Operation.

Table A-3: Arbitrary waveforms

Characteristics	Description
Waveform memory	Memory length: 32 400 000 words (8 bits/1 word)
Op.01	Memory length: 64 800 000 words (8 bits/1 word)
Marker memory	Memory length: 132 400 000 words (2 markers × 1 bit / 1 word)
Op.01	Memory length: 64 800 000 words (2 markers × 1 bit / 1 word)
Sequence memory	1 to 8000 steps

Table A-3: Arbitrary waveforms

Characteristics	Description
Sequence counter	1 to 65 536 and Infinite
Waveform data points	Multiple of 4 in the range from 960 to 32 400 000 points
Op.01	Multiple of 4 in the range from 960 to 64 800 000 points
Data storage	
Hard disk	≥20 G bytes
Floppy disk	1.44 M bytes

Table A-4: Clock generator

Characteristics	Description	PV reference page
Sampling frequency	50.000 000 kHz/s to 4.200 000 0 GHz/s	
Resolution	8 digits	
Internal clock ¹		
✓ Frequency accuracy	± 1 ppm (10 °C to 40 °C), during 1 year after calibration	Page B-48
Phase noise at VCO output, Typical	-65 dBc / Hz (4.2 GS/s with 10 kHz offset) -96 dBc / Hz (4.2 GS/s with 100 kHz offset)	

¹ The internal reference oscillator is used.

Table A-5: Internal trigger generator

Characteristics	Description	PV reference page
Internal trigger rate ²		
Accuracy	± 0.1 %	
Range	1.0 μs to 10.0 s	
Resolution	3 digits, minimum 0.1 μs	

² The internal reference oscillator is used.

Table A-6: Main output

Characteristics ³	Description	PV reference page
Output connector	front-panel SMA connectors	
Output signal	Complemental; CH1 and $\overline{\text{CH1}}$	
DA converter		
Resolution	8 bits	

Table A-6: Main output (cont.)

Characteristics ³	Description	PV reference page
Differential nonlinearity	Within $\pm 1/2$ LSB	
Integral nonlinearity	Within ± 1 LSB	
Output impedance	50 Ω	
Normal out (except option 02)		
Output voltage	-1.5 V to +1.5 V, into a 50 Ω load	
Amplitude		
Range	20 mV _{p-p} to 2 V _{p-p} , into a 50 Ω load	
Resolution	1 mV	
✓ DC accuracy	$\pm (2.0\% \text{ of amplitude} + 2 \text{ mV})$, offset: 0 V	Page B-19
Offset		
Range	-0.5 V to 0.5 V, into a 50 Ω load	
Resolution	1 mV	
✓ Accuracy	$\pm 1.5\% \text{ of offset} \pm 10 \text{ mV}$, (20 mV amplitude, waveform data: 0)	Page B-19
Pulse response	(Waveform data: -1 and 1, offset: 0 V, and filter: through, Clock: 1.0 GS/s)	
✓ Rise time (10 % to 90 %)	$\leq 480 \text{ ps}$ (amplitude = 1.0 V _{p-p} , calculated value $\geq 729 \text{ MHz}$)	Page B-31
✓ Fall time (10 % to 90 %)	$\leq 480 \text{ ps}$ (amplitude = 1.0 V _{p-p} , calculated value $\geq 729 \text{ MHz}$)	
Aberration, Typical	$\pm 6\%$ (amplitude + 1.0 V _{p-p} , using 6 GHz bandwidth oscilloscope)	
Flatness, Typical	$\pm 3\%$ (after 20 ns from rise or fall edges)	
Sinewave characteristics	(Clock: 4.2 GS/s, waveform points: 32, Signal frequency: 131.25 MHz, amplitude: 1.0 V, offset: 0 V, filter: through)	
Harmonics	$\leq -40 \text{ dBc}$ (DC to 1000 MHz)	
Noise	$\leq -50 \text{ dBc}$ (DC to 1000 MHz)	
Phase Noise, Typical	$\leq -85 \text{ dBc / Hz}$ (at 10 kHz offset)	
Direct DA out (except option 02)		
Amplitude		
Range	20 mV _{p-p} to 1 V _{p-p} , into a 50 Ω load	
✓ DC Accuracy	$\pm (2\% \text{ of Amplitude} + 2 \text{ mV})$	Page B-23
Resolution	1 mV	
✓ DC offset accuracy	0 V $\pm 10 \text{ mV}$, (20 mV amplitude, waveform data: 0)	Page B-23
✓ Pulse response	(Waveform data: -1 and 1, at 0.5 V _{p-p})	Page B-25
Rise time (10 % to 90 %)	$\leq 280 \text{ ps}$ (calculated value $\geq 1.25 \text{ GHz}$)	
Fall time (10 % to 90 %)	$\leq 280 \text{ ps}$ (calculated value $\geq 1.25 \text{ GHz}$)	
Extended Bandwidth output (option 02)		
Amplitude		

Table A-6: Main output (cont.)

Characteristics ³	Description	PV reference page
Range	500 mV _{p-p} to 1 V _{p-p} , into a 50 Ω load	Page B-27
✓ DC Accuracy	± (2 % of Amplitude + 2 mV)	
Resolution	1 mV	
✓ DC offset accuracy	0 V ± 10 mV, (500 mV amplitude, waveform data: 0)	Page B-27
✓ Pulse response	(Waveform data: -1 and 1, at 1 V _{p-p})	Page B-29
Rise time (10 % to 90 %)	≤ 175 ps (calculated value ≥ 2 GHz)	
Fall time (10 % to 90 %)	≤ 175 ps (calculated value ≥ 2 GHz)	

³ The characteristics are specified at the end of the SMA cable (174–1427–00) except for DC accuracy.

Table A-7: Filter (except option 02)

Characteristics	Description	
Type	Bessel low pass filter, 200 MHz, 100 MHz, 50 MHz, and 20 MHz	
Rise time (10 % to 90 %), Typical	20 MHz 50 MHz 100 MHz 200 MHz	17 ns 7 ns 3.7 ns 2 ns
Group delay, Typical	20 MHz 50 MHz 100 MHz 200 MHz	18 ns 8 ns 4.7 ns 3 ns

Table A-8: Auxiliary outputs

Characteristics	Description	PV reference page
Marker ⁴		
Number of markers	2 (Complementary). Marker1, <u>Marker1</u> , Marker2, and <u>Marker2</u>	
Connector	Front panel SMA connectors	
High Level (VoH) Range	-1.00 V to +2.45 V, into a 50 Ω load Refer to Figure A-8 on page A-16	
Low Level (VoL) Range	-2.00 V to +2.40 V, into a 50 Ω load Refer to Figure A-8 on page A-16	
Amplitude (VoH - VoL) Range	0.05 V _{p-p} , to 1.25 V _{p-p} into a 50 Ω load	
Resolution	50 mV	
✓ DC Accuracy	± 0.1 V ± 5 % of setting, into a 50 Ω load	Page B-50
Maximum Output Current	± 80 mA	

Table A-8: Auxiliary outputs (cont.)

Characteristics	Description	PV reference page
Rise and fall times (20 % to 80 %), Typical	<130 ps (High: 1.0 V, Lo: 0 V, into a 50 Ω load)	
Period jitter, Typical	Measured by TDS6604 with TDSJIT3. Refer to Table A-9.	
Cycle to Cycle jitter, Typical	Measured by TDS6604 with TDSJIT3. Refer to Table A-10.	
Skew, Typical	<20 ps	
Delay between Analog Output and Marker Output, Typical	Maker level: 1 V_{p-p} (High: +1.0 V, Low: 0 V), Analog Output Amplitude: 1 V_{p-p} , Offset: 0 V, Filter: Through, Refer to Figure A-1 on page A-9 2.4 ns (Normal Output, Offset: 0 V, Filter: Through) -1.0 ns (Direct Output) 2.0 ns (Option 02)	
VCO output		
Connector	Rear panel SMA connector	
Amplitude	0.4 V_{p-p} into a 50 Ω load 0.8 V_{p-p} max. open circuit	
Impedance	50 Ω , AC coupling	
Period jitter, Typical	Measured by TDS6604 with options 1M and HD and TDSJIT1. Refer to Table A-11.	
Cycle to Cycle jitter, Typical	Measured by TDS6604 with options 1M and HD and TDSJIT1. Refer to Table A-12.	
Connector	Rear panel SMA connector	
10 MHz Reference clock out		
Amplitude, Typical	1.2 V_{p-p} , into a 50 Ω load, Max 2.5 V_{p-p} , open circuit	
Impedance	50 Ω , AC coupling	
Connector	Rear panel BNC connector	
C Out 1, C Out 2 out		
Connector	This signal is used for only Synchronous operation between Master and Slave unit. Rear panel SMA connector	
Input Signal Type	Complementary	
T Out 1, T Out 2 out		
Connector	This signal is used for only Synchronous operation between Master and Slave unit. Rear panel SMA connector	
Input Signal Type	Complementary	
Display Monitor out		
Format	VGA	
Connector	15 pin, D-SUB, Rear panel	
Level	ECL	

Table A-8: Auxiliary outputs (cont.)

Characteristics	Description	PV reference page
-----------------	-------------	-------------------

⁴ The characteristics are specified at the end of the SMA cable (012-1565-00).

Table A-9: Marker output Period Jitter

Clock frequency	4.2 GS/s		2.1 GS/s		1.05 GS/s	
	StdDev	Pk-Pk	StdDev	Pk-Pk	StdDev	Pk-Pk
Marker output	2.0 ps	15 ps	2.0 ps	15 ps	2.0 ps	15 ps

Note.Period Jitter is measured with Clock Pattern (01010101.....)

Table A-10: Marker output Cycle to Cycle Jitter

Clock frequency	4.2 GS/s		2.1 GS/s		1.05 GS/s	
	StdDev	Pk-Pk	StdDev	Pk-Pk	StdDev	Pk-Pk
Marker output	3.4 ps	25 ps	3.4 ps	25 ps	3.7 ps	26 ps

Note.Cycle to Cycle Jitter is measured with Clock Pattern (01010101.....)

Table A-11: VCO output Period Jitter

Clock frequency	4.2 GS/s		2.1 GS/s		1.05 GS/s	
	StdDev	Pk-Pk	StdDev	Pk-Pk	StdDev	Pk-Pk
VCO output	1.4 ps	10 ps	1.4 ps	10 ps	1.4 ps	10 ps

Table A-12: VCO output Cycle to Cycle Jitter

Clock frequency	4.2 GS/s		2.1 GS/s		1.05 GS/s	
	StdDev	Pk-Pk	StdDev	Pk-Pk	StdDev	Pk-Pk
VCO output	2.4 ps	16ps	2.4 ps	16 ps	2.4 ps	16 ps

Table A-13: Auxiliary inputs

Characteristics	Description	PV reference page
Trigger input ⁵		
Connector	Rear panel BNC connector	
Impedance	1 k Ω or 50 Ω	
Polarity (Trigger mode)/ Slope (Gated mode)	POS (positive) or NEG (negative)	
Input voltage range	± 10 V, into a 1 k Ω load ± 5 V, into a 50 Ω load	
Threshold		
Level	-5.0 V to 5.0 V	
Resolution	0.1 V	
Triggered mode	See Figure A-1 on page A-9	
Minimum pulse width	10 ns, 0.2 V amplitude	
Trigger hold off time	≤ 109.5 clocks + 500 ns ; Single operation ≤ 109.5 clocks + 700 ns ; Synchronous operation	
Delay to analog out, Typical	275.5clocks + 17 ns (Output: Norm, Filter: Through)	
Gated mode	See Figure A-2 on page A-10	
Minimum pulse width	1152 clocks + 10 ns, 0.2 V amplitude	
Gate hold off time	≤ 1920 clock + 20 ns (The time interval between the last gate off point and the next gaate on point)	
Delay to analog out, Typical	(1355 to 1563.5) clocks + 9 ns (Output: Norm, Filter: Through)	

⁵ **The characteristics are specified at the end of the BNC cable (012-0482-00).**

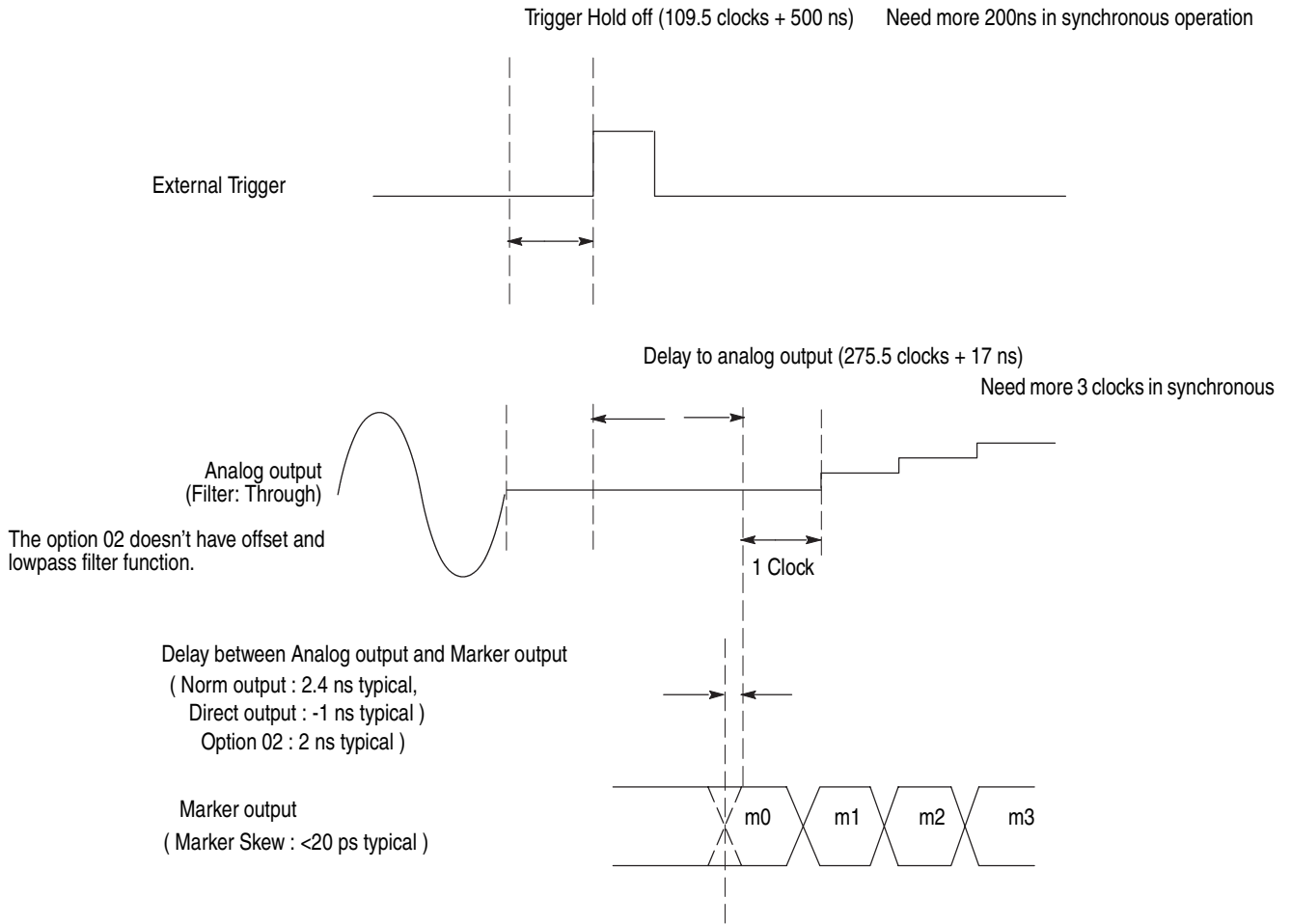
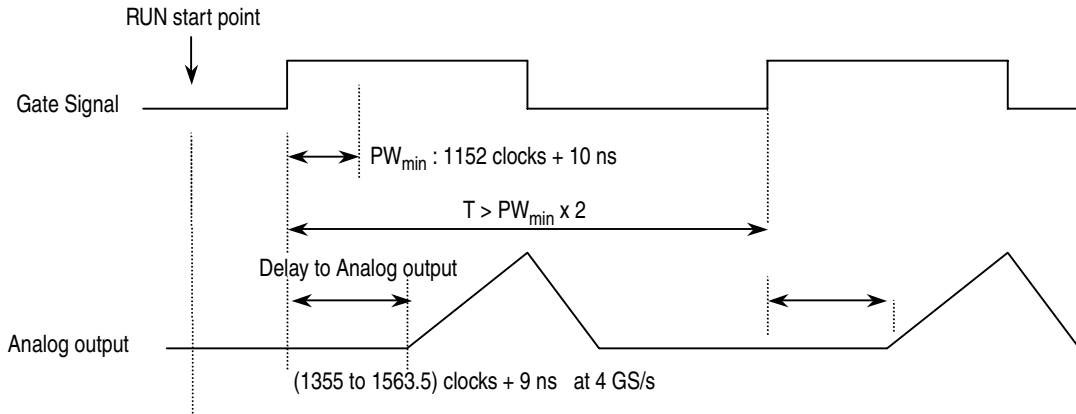

Figure A-1: Signal Timing

1. After RUN starting, Gate signal is input

1-1. The interval of Gate signal is longer than PW_{min} (Minimum Pulse Width) x 2



1-2. The interval of Gate signal is equal to PW_{min} (Minimum Pulse Width) x 2

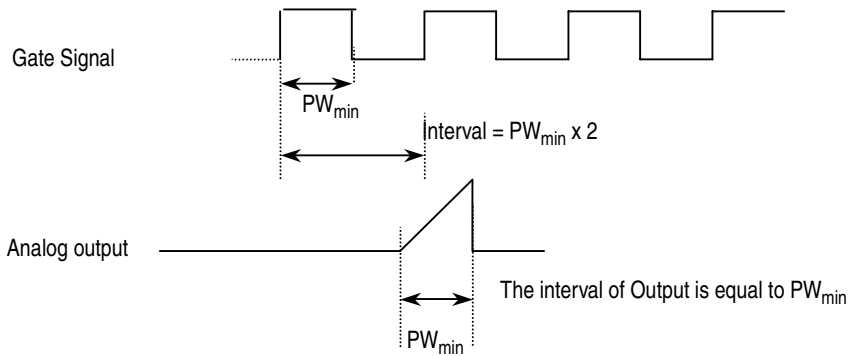

2. Before RUN starting, Gate signal is input

2-1. The interval of Gate signal is longer than PW_{min} (Minimum Pulse Width) x 2

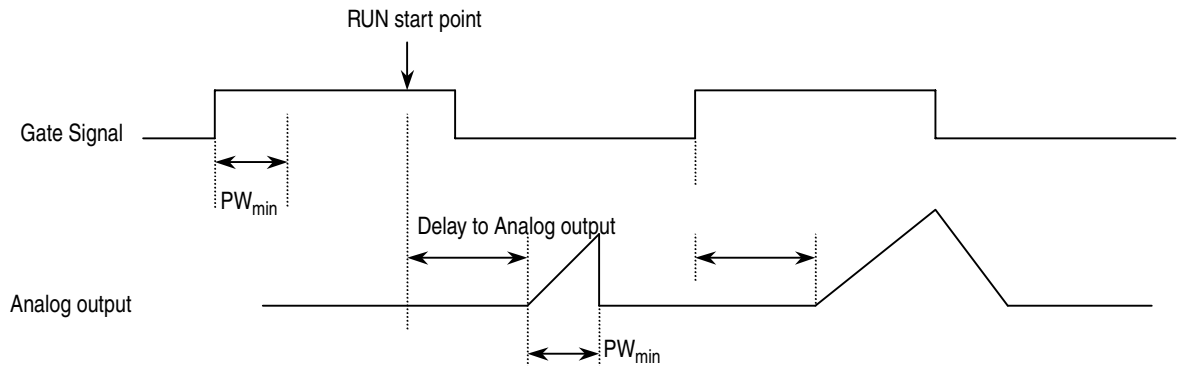

The only interval of 1st Output is equal to PW_{min} and the others are normal.

2-2. The interval of Gate signal is equal to PW_{min} (Minimum Pulse Width) x 2

As above 1-2, the interval of Analog Output is equal to PW_{min} .

Figure A-2: Gated Mode

1. Sequence 1

Line No.	Waveform Name	Wait for Trigger	Jump to
n:	Waveform1	Off	m (Waveform3)
n+1:	Waveform2	Off	m+1 (Waveform4)
m:	Waveform3	Off	--
m+1:	Waveform4	Off	--

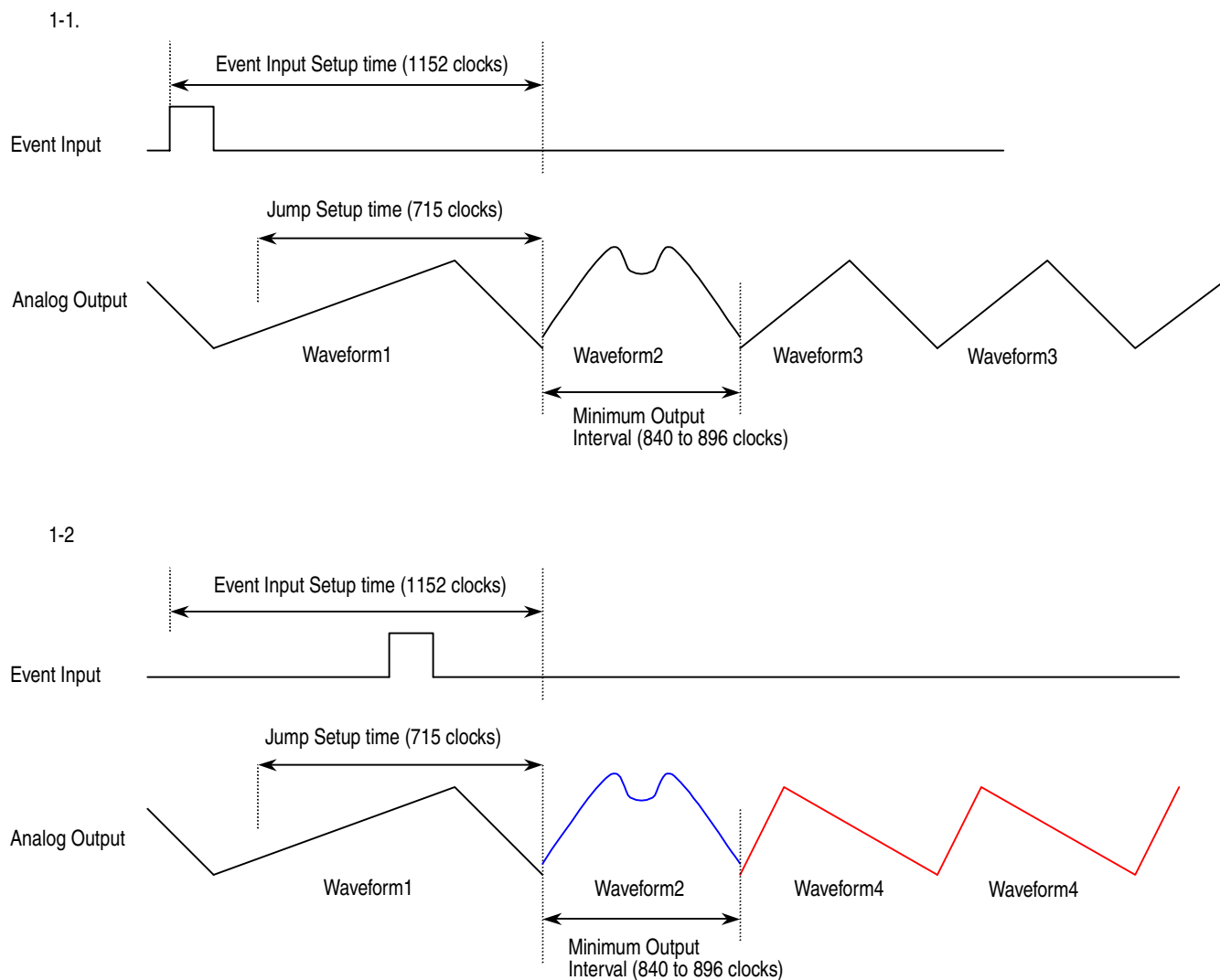

Figure A-3: Enhanced mode

2. Sequence 2

Line No.	Waveform Name	Wait for Trigger	Jump to
n:	Waveform1	Off	m (Waveform3)
n+1:	Waveform2	Off	m+1 (Waveform4)
m:	Waveform3	On	--
m+1:	Waveform4	On	--

2-1.

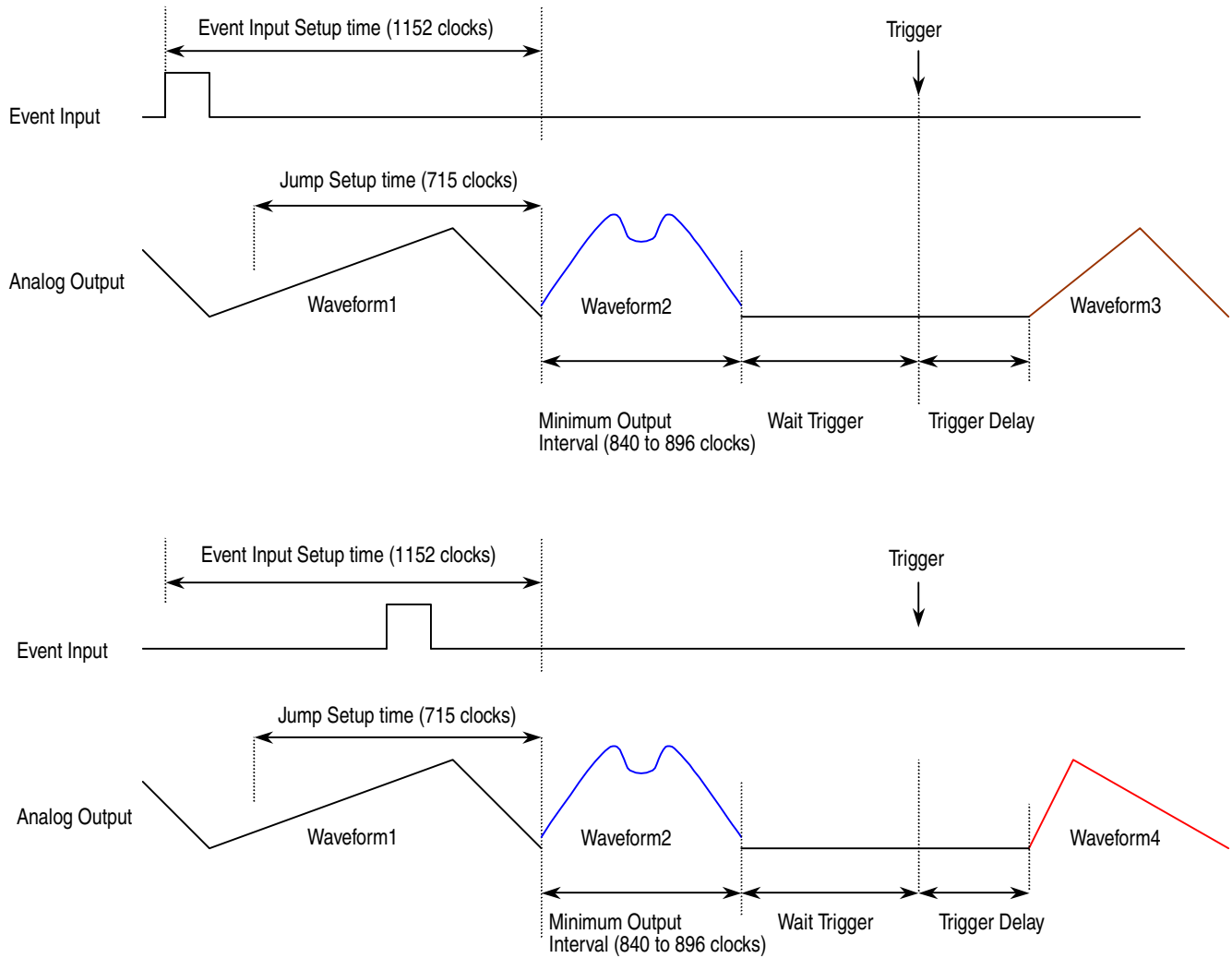

Figure A-4: Sequence 2

3. Sequence 3

Line No.	Waveform Name	Wait for Trigger	Jump to
n:	Waveform1	Off	m (Waveform3)
n+1:	Waveform2	On	m+1 (Waveform4)
m:	Waveform3	Off	--
m+1:	Waveform4	Off	--

3-1.

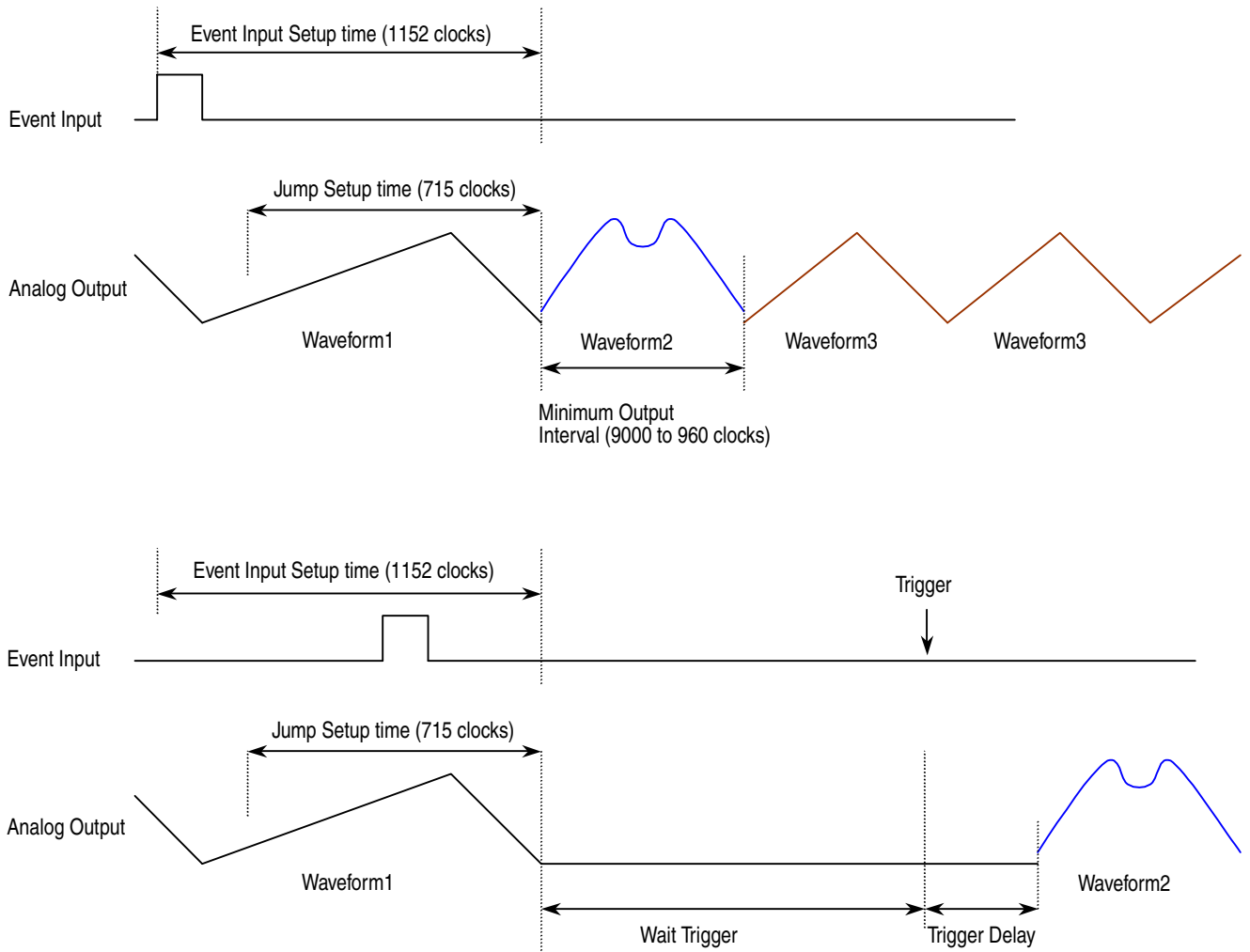

Figure A-5: Sequence 3

4. Sequence 4

Line No.	Waveform Name	Wait for Trigger	Jump to
n:	Waveform1	Off	m (Waveform3)
n+1:	Waveform2	On	m+1 (Waveform4)
m:	Waveform3	On	--
m+1:	Waveform4	On	--

4-1.

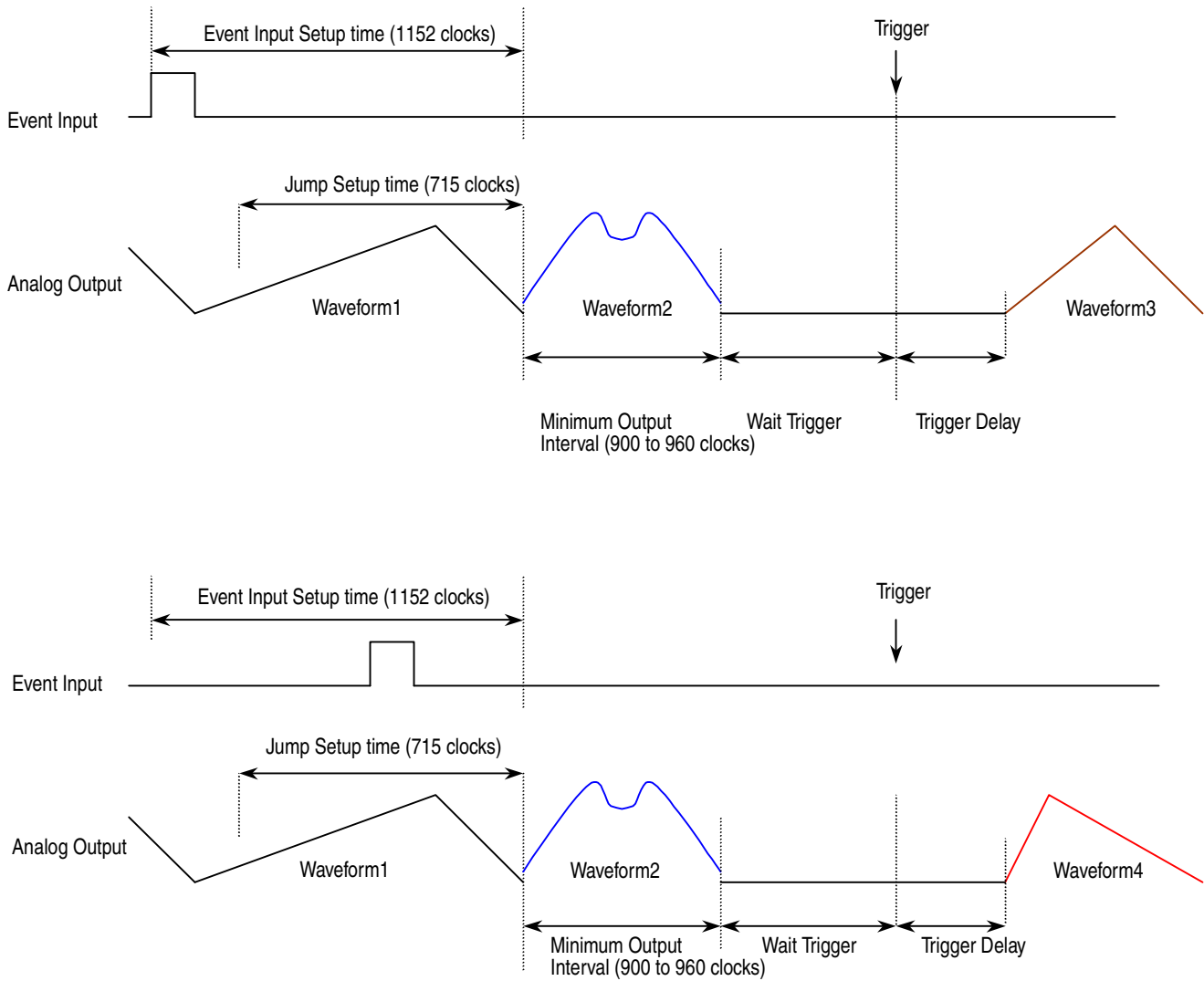

Figure A-6: 3-1. Sequence 4

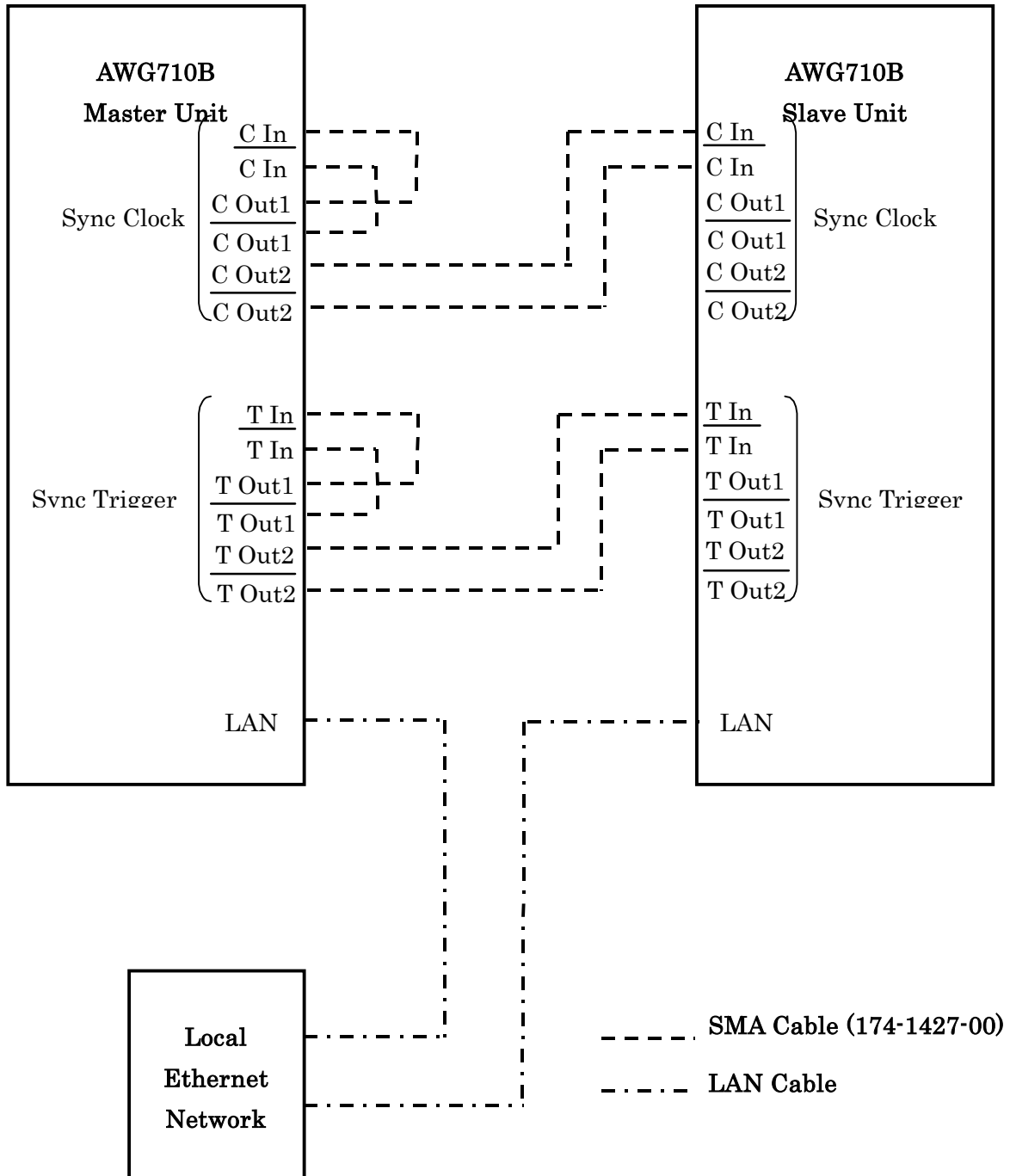

Figure A-7: The cable connection between units in Synchronous operation

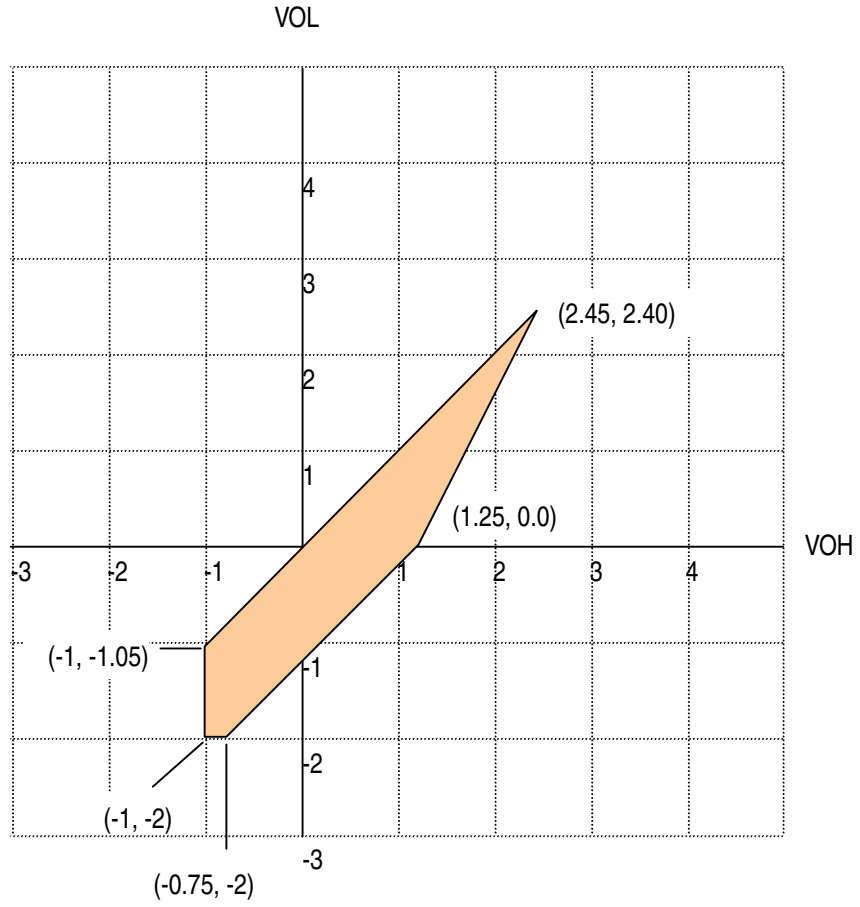
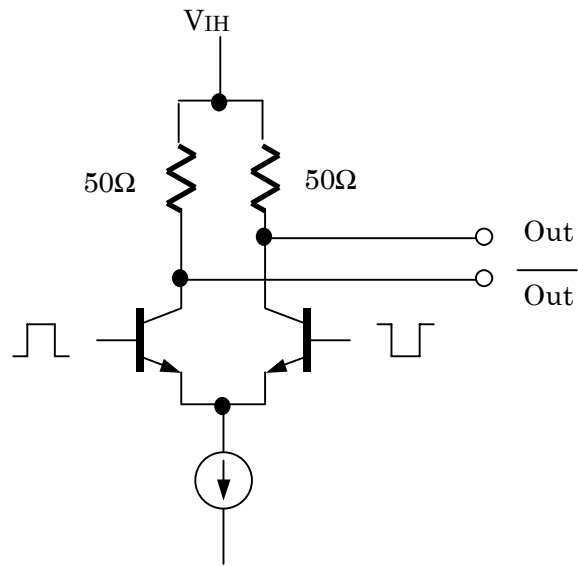

Figure A-8: Output Voltage Window (into 50Ω to GND) of MARKER



Marker output

Figure A-9: Output part equivalent circuit of MARKE

Table A-14: Event Input

Characteristics	Description
Connector	9-pin, D type on the rear panel
Number of events	7 bits
Input signal	7 event bits and Strobe
Threshold	TTL level
Maximum input	0 V to + 5 V (DC + peak AC)
Impedance	1 k Ω , pull-up to +3.3 V
Enhanced mode	
Minimum pulse width	320 clocks + 10 ns
Event hold off time	(The time interval between the last event input point and the next acceptable event input point) \leq 896 clocks + 20 ns
Delay to analog out, Typical (Jump timing: ASYNC)	(Output: Norm, Filter: Through)
Strobe: On	1691.5 clocks + 10 ns
Strobe: Off	1947.5 clocks + 6 ns
Event input to strobe input	
Setup time	192 clocks + 10 ns
Hold time	192 clocks + 10 ns

Table A-15: 10 MHz reference clock input

Characteristics	Description
Input voltage range	0.2 V _{p-p} to 3.0 V _{p-p} (into a 50 Ω load, AC coupling) Maximum \pm 10 V
Impedance	50 Ω , AC coupling
Frequency range	10 MHz \pm 0.1 MHz
Connector	Rear panel BNC connector

Table A-16: External clock input

Characteristics	Description
Connector	Rear panel SMA connector
Impedance	50 Ω , AC coupling
Required input voltage range swing	0.4 V _{p-p} to 2 V _{p-p} into a 50 Ω load
Required duty cycle	50 \pm 5 %

Table A-16: External clock input

Characteristics	Description
Frequency range	125 MHz to 4.2 GHz Note: Slew rate should be more than 10 mV/ns.

Table A-17: C input

Characteristics	Description
Connector	This signal is used for only Synchronous operation between Master and Slave unit. Rear panel SMA connector
Input signal type	Complementary

Table A-18: T input

Characteristics	Description
Connector	This signal is used for only Synchronous operation between Master and Slave unit. Rear panel SMA connect
Input signal type	Complementary

Table A-19: Function Generator (FG)

Characteristics	Description																		
Operation Mode	Continuous mode only																		
Waveform Shape	Sine, Triangle, Square, Ramp, Pulse, DC																		
Frequency	1.000 Hz to 400.0 MHz																		
Amplitude																			
Range	0.020 V _{p-p} to 2.000 V _{p-p} , into a 50 Ω load (OPTION02 : 0.5 V _{p-p} to 1.0 V _{p-p} , into a 50 Ω load)																		
Resolution	1 mV																		
Offset (except option 02)																			
Range	-0.500 V to +0.500 V, into a 50 Ω load																		
Resolution	1 mV																		
DC Level (except option 02)	DC waveform only																		
Range	-0.500 V to +0.500 V, into a 50 Ω load																		
Resolution	1 mV																		
Polarity	Normal, Inverted																		
Duty																			
Range	0.1 % to 99.9 %																		
Resolution	<table border="0"> <tr> <td>Frequency</td> <td>Resolution</td> </tr> <tr> <td>1.000 Hz to 4.000 MHz</td> <td>0.1 %</td> </tr> <tr> <td>4.001 MHz to 20.00 MHz</td> <td>0.5 %</td> </tr> <tr> <td>20.01 MHz to 40.00 MHz</td> <td>1.0 %</td> </tr> <tr> <td>40.01 MHz to 80.00 MHz</td> <td>2.0 %</td> </tr> <tr> <td>80.01 MHz to 100.0 MHz</td> <td>2.5 %</td> </tr> <tr> <td>100.1 MHz to 160.0 MHz</td> <td>4.0 %</td> </tr> <tr> <td>160.1 MHz to 200.0 MHz</td> <td>5.0 %</td> </tr> <tr> <td>200.1 MHz to 400.0 MHz</td> <td>10.0 %</td> </tr> </table>	Frequency	Resolution	1.000 Hz to 4.000 MHz	0.1 %	4.001 MHz to 20.00 MHz	0.5 %	20.01 MHz to 40.00 MHz	1.0 %	40.01 MHz to 80.00 MHz	2.0 %	80.01 MHz to 100.0 MHz	2.5 %	100.1 MHz to 160.0 MHz	4.0 %	160.1 MHz to 200.0 MHz	5.0 %	200.1 MHz to 400.0 MHz	10.0 %
Frequency	Resolution																		
1.000 Hz to 4.000 MHz	0.1 %																		
4.001 MHz to 20.00 MHz	0.5 %																		
20.01 MHz to 40.00 MHz	1.0 %																		
40.01 MHz to 80.00 MHz	2.0 %																		
80.01 MHz to 100.0 MHz	2.5 %																		
100.1 MHz to 160.0 MHz	4.0 %																		
160.1 MHz to 200.0 MHz	5.0 %																		
200.1 MHz to 400.0 MHz	10.0 %																		
Marker Out																			
Pulse Width																			
Mrker1	Hi : 0 % to 20 % of 1 waveform period Lo : 20% to 100 % of 1 waveform period																		
Marker2	Hi : 0 % to 50 % of 1 waveform period Lo : 50 % to 100 % of 1 waveform period Hi : 0 % to 52 % of 1 waveform period Lo : 52 % to 100 % of 1 waveform period at frequency range is 100.1MHz to 160.0MHz																		
Level																			
Hi	1.0 V min into a 50 Ω load																		
Lo	0 V max into a 50 Ω load																		

Table A-20: Display

Characteristics	Description
Display	
Size	16 cm (6.4 in.) diag. LCD
Display area	Horizontal: 130.6 mm (5.14 in)
	Vertical: 97.0 mm (3.81 in)
Resolution	640 (H) × 480 (V) pixels

Table A-21: AC line power

Characteristics	Description
Rating voltage	100 VAC to 240 VAC, CAT II
Voltage range	90 VAC to 250 VAC
Frequency range	48 Hz to 63 Hz
Maximum consumption	240 VA
Maximum current	5 A
Fuse rating	10 A fast, 250 V, UL 198G (3 AG) 5 A (T), 250 V, IEC 127

Table A-22: Timer

Characteristics	Description
Timer	
Operation time	6 years
Type	Li 3 V, 190 mAh

Table A-23: Interface connectors

Characteristics	Description
GPIB	24-pin, IEEE 488.1 connector on the rear panel
Ethernet	100/10 BASE-T, RJ-45 connector on the rear panel
Keyboard connector	6-pin, mini-DIN connector on the rear panel

Table A-24: Installation requirement

Characteristics	Description
Heat dissipation Maximum power	220 W max. (maximum line current: 3 A _{rms} , at 50 Hz)
Surge current	30 A (25 °C) peak for equal to or less than 5 line cycles, after the instrument has been turned off for at least 30s
Cooling clearance	Top, 2 cm (0.8 in) Bottom 2 cm (0.8 in)
	<i>NOTE: The feet on the bottom provide the required clearance when set on a flat surface.</i>
	Sides 15 cm (6 in)
	Rear 7.5 cm (3 in)

Table A-25: Maintenance requirement

Characteristics	Description
Calibration	The instrument should be fully calibrated at least every 12 months.

Table A-26: Environmental

Characteristics	Description
Atmospherics	
Temperature	
Operating	+10 °C to +40 °C
Non-operating	-20 °C to +60 °C
Relative humidity	
Operating	20 % to 80 % (no condensation) Maximum wet-bulb temperature 29.4 °C
Non-operating	5 % to 90 % (no condensation) Maximum wet-bulb temperature 40.0 °C
Altitude	(Hard disk drive restriction)
Operating	Up to 3 km (10 000 ft) Maximum operating temperature decreases 1 °C each 300 m (1 000 ft) above 1.5 km (5 000 ft)
Non-operating	Up to 12 km (40 000 ft)

Table A-26: Environmental

Dynamics	
Random vibration	
Operating	2.646 m/s ² rms (0.27Grms), from 5 Hz to 500 Hz, 10 minutes
Non-operating	22.344 m/s ² rms (2.28Grms), from 5 Hz to 500 Hz, 10 minutes
Shock	
Non-operating	294 m/s ² (30 G), half-sine, 11 ms duration

Table A-27: Mechanical

Characteristics	Description
Net weight (without package)	14.1 kg (31.1 lb) Opt. 11:16.1 kg (35.5 lb)
Dimensions (without package)	Height 177 mm (6.97 in) 193 mm (7.60 in) with Feet Opt.11: 216 mm (8.50 in) 232 mm (9.13 in) with Feet
	Width 424 mm (16.69 in) 433 mm (17.05 in) with Handle
	Length 470 mm (18.50 in) 508 mm (20.00 in) with Rear Feet
Net weight (with package)	24.5 kg (54.0 lb)
Dimensions (with package)	Height 400 mm (15.75 in)
	Width 550 mm (21.65 in)
	Length 700 mm (27.56 in)

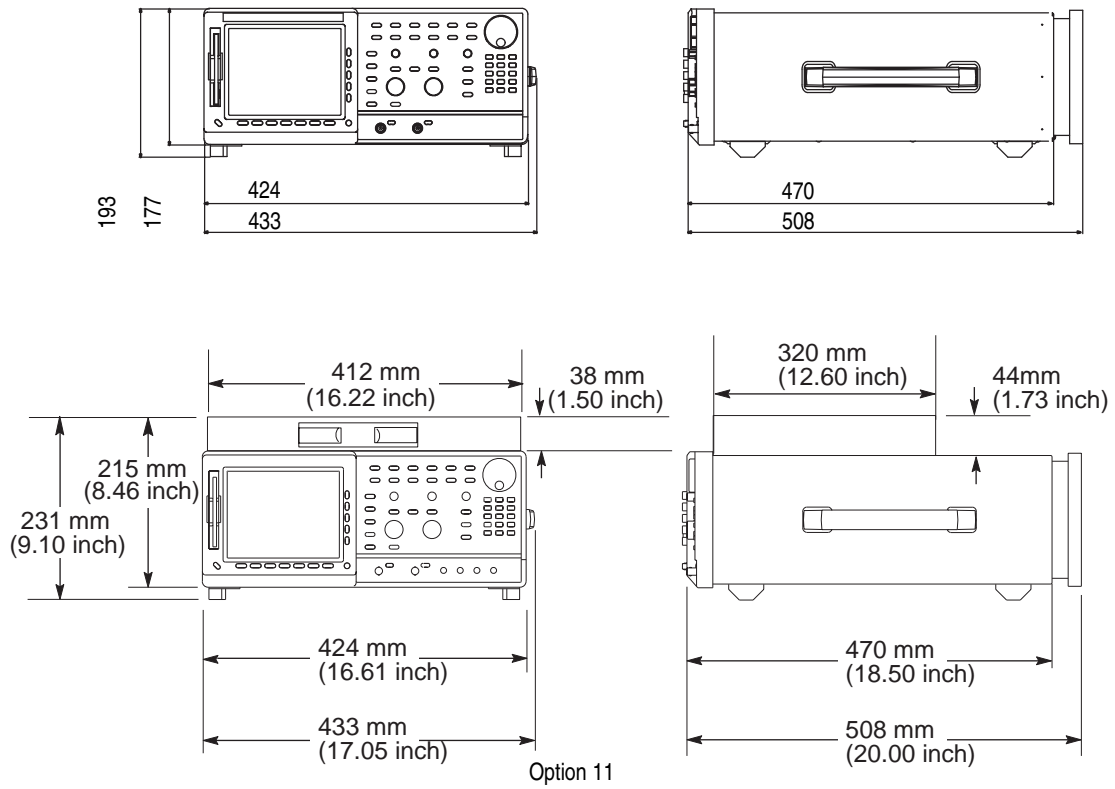

Figure A-10: Dimensions

Certification and Compliances

The certification and compliances for the AWG710B Arbitrary Waveform Generator are listed in Table A-28.

Table A-28: Certifications and compliances

Characteristics	Description																								
EC declaration of conformity	<p>EC council EMC Directive 89/336/EEC, amended by 89/336/EEC; EN61326-1: 1997 Product Family Standard for Electrical Equipment for Measurement, Control, and Laboratory Use-EMC Requirements.</p> <p>Emissions:</p> <table> <tr> <td>EN 55011 Class A</td> <td>Radiated and Conducted emissions</td> </tr> <tr> <td>EN 61000-3-2</td> <td>Power Line Harmonic</td> </tr> <tr> <td>EN 61000-3-3</td> <td>Line voltage alteration and flicker</td> </tr> </table> <p>Immunity:</p> <table> <tr> <td>EN50082-1</td> <td></td> </tr> <tr> <td>EN 61000-4-2</td> <td>Electrostatic Discharge Immunity</td> </tr> <tr> <td>EN 61000-4-3</td> <td>Radiated RF Electromagnetic Field Immunity</td> </tr> <tr> <td>EN 61000-4-5</td> <td>Surge Immunity</td> </tr> <tr> <td>EN 61000-4-6</td> <td>Conducted Disturbances Induced by RF Field Immunity</td> </tr> <tr> <td>EN 61000-4-4⁶</td> <td>Electrical Fast Transient/Burst Immunity</td> </tr> <tr> <td>EN 61000-4-8</td> <td>Power Frequency Electromagnetic</td> </tr> <tr> <td>EN 61000-4-11</td> <td>Power Line Interruption Immunity</td> </tr> </table> <p>Compliance was demonstrated to the following specification as listed in the Official Journal of the European Communities:</p> <p>Low Voltage Directive 73/23/EEC, amended by 93/68/EEC</p> <table> <tr> <td>EN 61010-1/A2:1995</td> <td>Safety requirements for electrical equipment for measurement, control, and laboratory use</td> </tr> </table>	EN 55011 Class A	Radiated and Conducted emissions	EN 61000-3-2	Power Line Harmonic	EN 61000-3-3	Line voltage alteration and flicker	EN50082-1		EN 61000-4-2	Electrostatic Discharge Immunity	EN 61000-4-3	Radiated RF Electromagnetic Field Immunity	EN 61000-4-5	Surge Immunity	EN 61000-4-6	Conducted Disturbances Induced by RF Field Immunity	EN 61000-4-4 ⁶	Electrical Fast Transient/Burst Immunity	EN 61000-4-8	Power Frequency Electromagnetic	EN 61000-4-11	Power Line Interruption Immunity	EN 61010-1/A2:1995	Safety requirements for electrical equipment for measurement, control, and laboratory use
EN 55011 Class A	Radiated and Conducted emissions																								
EN 61000-3-2	Power Line Harmonic																								
EN 61000-3-3	Line voltage alteration and flicker																								
EN50082-1																									
EN 61000-4-2	Electrostatic Discharge Immunity																								
EN 61000-4-3	Radiated RF Electromagnetic Field Immunity																								
EN 61000-4-5	Surge Immunity																								
EN 61000-4-6	Conducted Disturbances Induced by RF Field Immunity																								
EN 61000-4-4 ⁶	Electrical Fast Transient/Burst Immunity																								
EN 61000-4-8	Power Frequency Electromagnetic																								
EN 61000-4-11	Power Line Interruption Immunity																								
EN 61010-1/A2:1995	Safety requirements for electrical equipment for measurement, control, and laboratory use																								
Australia/New Zealand declaration of conformity - EMC	<p>Conforms with the following standards in accordance with the Electromagnetic Compatibility Framework:</p> <p>AS/NZS 2064.1/2</p> <p>Class A radiated and Conducted Emissions</p>																								
Safety	<p>UL3111-1 - Standard for electrical measuring and test equipment</p>																								
Third party certification	CAN/CSA C22.2 No. 1010.1 - Safety requirements for electrical equipment for measurement, control and laboratory use																								
Self declaration	IEC 61010-1/A2:1995 - Safety requirements for electrical equipment for measurement, control, and laboratory use																								
Installation category	Power input — Installation Category II (as defined in IEC 61010-1, Annex J)																								

Table A-28: Certifications and compliances

Characteristics	Description
Pollution degree	Pollution Degree 2 (as defined in IEC 61010-1)

⁶ Up to 200 mV_{p-p} noise is allowed on the output during this test.

Table A-29: Installation category and Pollution degree Descriptions

Characteristics	Description
Installation category	Terminals on this product may have different installation category designations. The installation categories are:
	<i>Category</i> <i>Descriptions</i>
	CAT IIIe Distribution-level mains (usually permanently connected). Equipment at this level is typically in a fixed industrial location
	CAT II Local-level mains (wall sockets). Equipment at this level includes appliances, portable tools, and similar products. Equipment is usually cord-connected
CAT I Secondary (signal level) or battery operated circuits of electronic equipment	
Pollution degree	A measure of the contaminants that could occur in the environment around and within a product. Typically the internal environment inside a product is considered to be the same as the external. Products should be used only in the environment for which they are rated.
	<i>Category</i> <i>Descriptions</i>
	Pollution Degree 1 No pollution or only dry, nonconductive pollution occurs. Products in this category are generally encapsulated, hermetically sealed, or located in clean rooms.
	Pollution Degree 2 Normally only dry, nonconductive pollution occurs. Occasionally a temporary conductivity that is caused by condensation must be expected. This location is a typical office/home environment. Temporary condensation occurs only when the product is out of service.
	Pollution Degree 3 Conductive pollution, or dry, nonconductive pollution that becomes conductive due to condensation. These are sheltered locations where neither temperature nor humidity is controlled. The area is protected from direct sunshine, rain, or direct wind.
Pollution Degree 4 Pollution that generates persistent conductivity through conductive dust, rain, or snow. Typical outdoor locations.	

Appendix A: Specifications (AWG710)

This section contains the AWG710 Arbitrary Waveform Generator specifications. All specifications are guaranteed unless labeled “typical”. Typical specifications are provided for your convenience but are not guaranteed.

Specifications that are marked with the ✓ symbol in the column Characteristics are checked in *Appendix B: Performance Verification* and the page number referenced to the corresponding performance verification procedures can be found in the column PV reference page.

The characteristics in the specifications are listed in tables that are divided into categories. In these tables, the subcategories may also appear in boldface under the column Characteristics.

Performance Conditions

The performance limits in this specification are valid with these conditions:

- The AWG710 Arbitrary Waveform Generator must have been calibrated/adjusted at an ambient temperature between +20° C and +30° C.
- The AWG710 Arbitrary Waveform Generator must be in an environment with temperature, altitude, humidity, and vibration within the operating limits described in these specifications.
- The AWG710 Arbitrary Waveform Generator must have had a warm-up period of at least 20 minutes.
- The AWG710 Arbitrary Waveform Generator must be operating at an ambient temperature between +10° C and +40° C.

Warranted characteristics are described in terms of quantifiable performance limits which are warranted.

Electrical Specification

Table A-30: Operation modes

Characteristics	Description
Continuous	Waveform is continuously output in this mode. When a sequence is defined, waveforms are sequentially or repeatedly output in the order defined by the sequence. The extended sequence functions such as trigger input, event jump, and so on are neglected in this mode.
Triggered	Waveform is output only once when a trigger event is created. A trigger signal is created by the external trigger input signal, GPIB trigger command, and/or pressing the front-panel FORCE TRIGGER button. The extended sequence functions such as trigger input, event jump, and so on are neglected in this mode.
Gated	The waveform is output in the same way as in the continuous mode only when the gate is opened. The gate is opened by the gated signal. Note that the output is made from the top of the first waveform for every gate period. The clock signal continuously outputs from the connector outside the gate period.
Enhanced	The waveforms are sequentially or repeatedly output according to the procedures defined in the sequence. All extended functions such as trigger input, event jump, and so on are effective and waveforms are controlled for output by these functions in this mode.

Table A-31: Arbitrary waveforms

Characteristics	Description
Waveform memory	Memory length: 16 200 000 words (8 bits/1 word)
Op.01	Memory length: 32 400 000 words (8 bits/1 word)
Marker memory	Memory length: 16 200 000 words (2 markers × 1 bit / 1 word)
Op.01	Memory length: 32 400 000 words (2 markers × 1 bit / 1 word)
Sequence memory	Maximum 8000 steps
Sequence counter	1 to 65 536 and Infinite
Waveform data points	Multiple of 4 in the range from 960 to 16 200 000 points
Op.01	Multiple of 4 in the range from 960 to 32 400 000 points
Data storage	
Hard disk	10 G bytes
Floppy disk	1.44 M bytes

Table A-32: Clock generator

Characteristics	Description	PV reference page
Sampling frequency	50.000 000 kHz to 4.000 000 0 GHz	
Resolution	8 digits	
Internal clock ¹		
✓ Frequency accuracy	± 1 ppm (10 °C to 40 °C), during 1 year after calibration	Page B-98
Phase noise at 1/4 clock output, Typical	(Data Clock is 1/4th of the output sample rate) -80 dBc / Hz (1 GHz with 10 kHz offset) -100 dBc/Hz (1 GHz with 100 kHz offset)	

¹ The internal reference oscillator is used.

Table A-33: Internal trigger generator

Characteristics	Description	PV reference page
Internal trigger rate ²		
Accuracy	± 0.1 %	
Range	1.0 μs to 10.0 s	
Resolution	3 digits, minimum 0.1 μs	

² The internal reference oscillator is used.

Table A-34: Main output

Characteristics	Description	PV reference page
Output connector	front-panel SMA connectors	
Output signal	Complemental; CH1 and $\overline{\text{CH1}}$	
DA converter		
Resolution	8 bits	
Differential nonlinearity	Within ± 1/2 LSB	
Integral nonlinearity	Within ± 1 LSB	
Output impedance	50 Ω	
Normal out (except option 02)		
Output voltage	-1.5 V to +1.5 V, into a 50 Ω load	
Amplitude		
Range	20 mV _{p-p} to 2 V _{p-p} , into a 50 Ω load	
Resolution	1 mV	
✓ DC accuracy	± (2.0 % of amplitude + 2 mV), offset: 0 V	Page B-72

Table A-34: Main output

Characteristics ³	Description	PV reference page
Offset		
Range	-0.5 V to 0.5 V, into a 50 Ω load	
Resolution	1 mV	
✓ Accuracy	± 1.5 % of offset ± 10 mV, (20 mV amplitude, waveform data: 0)	Page B-72
Pulse response		
	(Waveform data: -1 and 1, offset: 0 V, and filter: through)	
✓ Rise time (10 % to 90 %)	≤ 480 ps (amplitude = 1.0 V _{p-p} , calculated value ≥ 729 MHz)	Page B-85
✓ Fall time (10 % to 90 %)	≤ 480 ps (amplitude = 1.0 V _{p-p} , calculated value ≥ 729 MHz)	
Aberration, Typical	± 6 % (amplitude + 1.0 V _{p-p} , using 6 GHz bandwidth oscilloscope)	
Flatness, Typical	± 3 % (after 20 ns from rise and fall edges)	
Sinewave characteristics		
	(Clock: 4.0 GS/s, waveform points: 32, Signal frequency: 125 MHz, amplitude: 1.0 V, offset: 0 V, filter: through)	
Harmonics	≤ -40 dBc (DC to 1000 MHz)	
Noise	≤ -50 dBc (DC to 1000 MHz)	
Phase Noise, Typical	≤ -85 dBc / Hz (at 10 kHz offset)	
Direct DA out (except option 02)		
Amplitude		
Range	20 mV _{p-p} to 1 V _{p-p} , into a 50 Ω load	
✓ DC Accuracy	± (2 % of Amplitude + 2 mV)	Page B-77
Resolution	1 mV	
✓ DC offset accuracy	0 V ± 10 mV, (20 mV amplitude, waveform data: 0)	Page B-77
✓ Pulse response	(Waveform data: -1 and 1, at 0.5 V _{p-p})	Page B-79
Rise time (10 % to 90 %)	≤ 280 ps (calculated value ≥ 1.25 GHz)	
Fall time (10 % to 90 %)	≤ 280 ps (calculated value ≥ 1.25 GHz)	
Extended Bandwidth output (option 02)		
Amplitude		
Range	500 mV _{p-p} to 1 V _{p-p} , into a 50 Ω load	
✓ DC Accuracy	± (2 % of Amplitude + 2 mV)	Page B-81
Resolution	1 mV	
✓ DC offset accuracy	0 V ± 10 mV, (500 mV amplitude, waveform data: 0)	Page B-81
✓ Pulse response	(Waveform data: -1 and 1, at 1 V _{p-p})	Page B-83
Rise time (10 % to 90 %)	≤ 175 ps (calculated value ≥ 2 GHz)	
Fall time (10 % to 90 %)	≤ 175 ps (calculated value ≥ 2 GHz)	

³ The characteristics are specified at the end of the SMA cable (012-1565-00) except for DC accuracy.

Table A-35: Filter (except option 02)

Characteristics	Description	
Type	Bessel low pass filter, 200 MHz, 100 MHz, 50 MHz, and 20 MHz	
Rise time (10 % to 90 %), Typical	20 MHz 50 MHz 100 MHz 200 MHz	17 ns 7 ns 3.7 ns 2 ns
Group delay, Typical	20 MHz 50 MHz 100 MHz 200 MHz	18 ns 8 ns 4.7 ns 3 ns

Table A-36: Auxiliary outputs

Characteristics	Description	PV reference page
Marker ⁴		
Number of markers	2 (Complementary). Marker1, $\overline{\text{Marker1}}$, Marker2, and $\overline{\text{Marker2}}$	
Level (Hi/Lo)	-1.10 V to +3.00 V, into a 50 Ω load -2.20 V to +6.00 V, into a 1 M Ω load	
Maximum Output	2.5 V _{p-p} , into a 50 Ω load	
Resolution	0.05 V	
✓ Accuracy	$\pm 0.1 \text{ V} \pm 5 \%$ of setting, into a 50 Ω load	Page B-100
Rise and fall times (20 % to 80 %), Typical	150 ps (2 V _{p-p} , Hi: +1 V, Lo: -1 V, into a 50 Ω load)	
Skew, Typical	70 ps	
Period jitter, Typical	Measured by TDS694C with options 1M and HD and TDSJIT1. Refer to Table A-37.	
Cycle to cycle jitter, Typical	Measured by TDS694C with options 1M and HD and TDSJIT1. Refer to Table A-38.	
Connector	Front panel SMA connectors	
1/4 Clock output		
Level	ECL 100 K compatible (internally loaded in 50 Ω to -2 V and 47 Ω series terminated)	
Period jitter, Typical	Measured by TDS694C with options 1M and HD and TDSJIT1. Refer to Table A-37.	
Cycle to cycle jitter, Typical	Measured by TDS694C with options 1M and HD and TDSJIT1. Refer to Table A-38.	
Connector	Rear panel SMA connector	

Table A-36: Auxiliary outputs

Characteristics	Description	PV reference page
10 MHz Reference clock out		
Amplitude, Typical	$\geq 1.2 V_{p-p}$, into a 50Ω load, Max $2.5 V_{p-p}$, open circuit	
Impedance	50Ω , AC coupling	
Connector	Rear panel BNC connector	

⁴ The characteristics are specified at the end of the SMA cable (012-1565-00).

Table A-37: Period Jitter

Clock frequency	4 GS/s		2 GS/s		1 GS/s	
	StdDev	Pk-Pk	StdDev	Pk-Pk	StdDev	Pk-Pk
Measurement						
Marker output	1.6 ps	11.6 ps	1.9 ps	13.4 ps	2.5 ps	15.1 ps
1/4 Clock output	2.6 ps	20.2 ps	2.4 ps	27.5 ps	1.9 ps	14.0 ps

Table A-38: Cycle to Cycle Jitter

Clock frequency	4 GS/s		2 GS/s		1 GS/s	
	StdDev	Pk-Pk	StdDev	Pk-Pk	StdDev	Pk-Pk
Measurement						
Marker output	3.1 ps	21.4 ps	3.2 ps	26.1 ps	3.1 ps	21.9 ps
1/4 Clock output	4.8 ps	44.5 ps	3.7 ps	33.3 ps	3.1 ps	28.7 ps

Table A-39: Auxiliary inputs

Characteristics	Description	PV reference page
Trigger input ⁵		
Connector	Rear panel BNC connector	
Impedance	1 k Ω or 50 Ω	
Polarity (Trigger mode)/Slope (Gated mode)	POS (positive) or NEG (negative)	
Input voltage range	± 10 V, into a 1 k Ω load ± 5 V, into a 50 Ω load	
Threshold		
Level	-5.0 V to 5.0 V	
✓ Accuracy	± 5 % of level ± 0.1 V	Page B-87
Resolution	0.1 V	
Triggered mode	See Figure A-11	
Minimum pulse width	10 ns, 0.2 V amplitude	
Trigger hold off time	≤ 109.5 clocks + 500 ns	
Delay to analog out, Typical	211.5 clocks + 17 ns (Output: Norm, Filter: Through)	
Gated mode		
Minimum pulse width	1152 clocks + 10 ns, 0.2 V amplitude	
Gate hold off time	≤ 1920 clock + 20 ns	
Delay to analog out, Typical	(1335 to 1499.5) clocks + 9 ns (Output: Norm, Filter: Through)	

⁵ The characteristics are specified at the end of the BNC cable (012-0482-00).

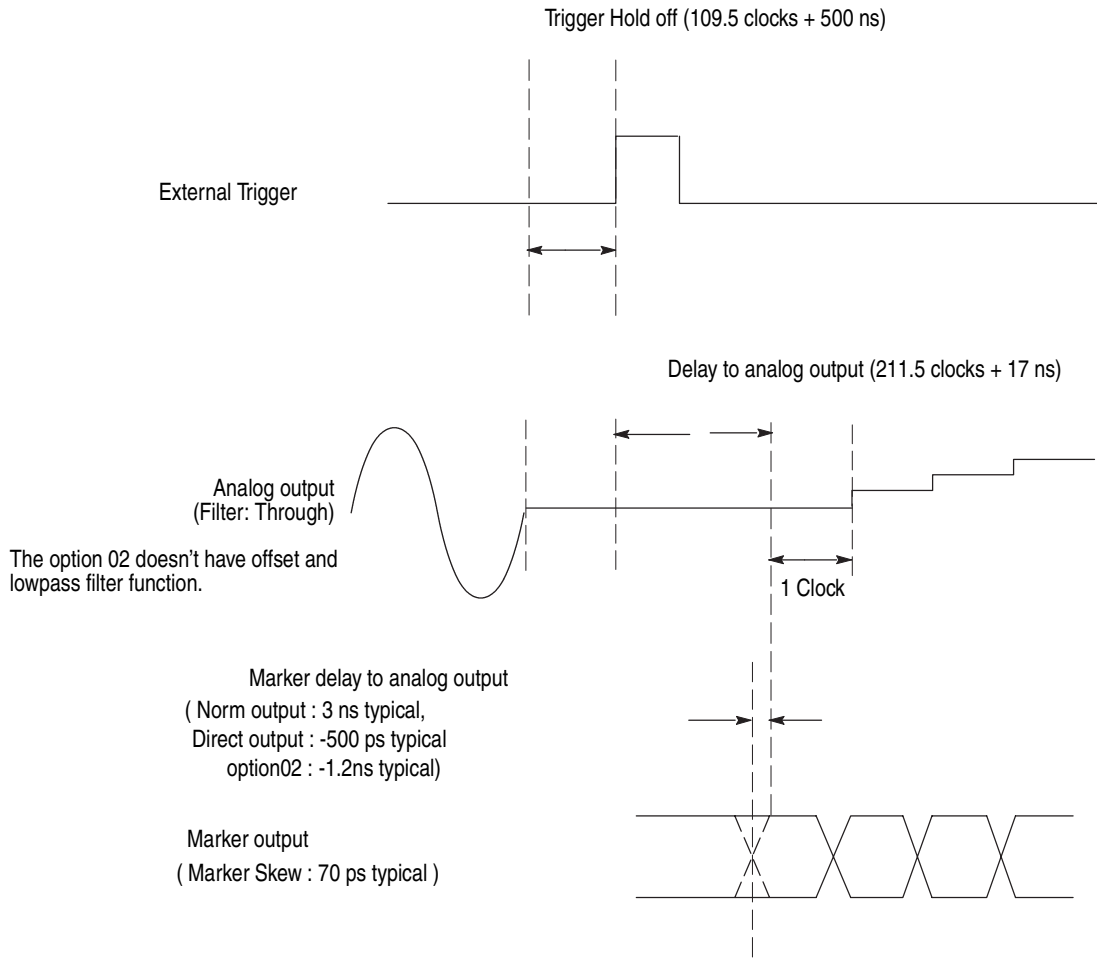

Figure A-11: Signal Timing

Table A-40: Event Input

Characteristics	Description
Connector	9-pin, D type on the rear panel
Number of events	4 bits
Input signal	4 event bits and Strobe
Threshold	TTL level
Maximum input	0 V to + 5 V (DC + peak AC)
Impedance	1 k Ω , pull-up to +3.3 V
Enhanced mode	
Minimum pulse width	320 clocks + 10 ns
Event hold off time	\leq 896 clocks + 20 ns
Delay to analog out, Typical (Jump timing: ASYNC)	(Output: Norm, Filter: Through)
Strobe: On	1627.5 clocks + 7 ns
Strobe: Off	1883.5 clocks + 5 ns
Event input to strobe input	
Setup time	192 clocks + 10 ns
Hold time	192 clocks + 10 ns

Table A-41: 10 MHz reference clock input

Characteristics	Description
Input voltage range	0.2 V to 3.0 V _{p-p} (into a 50 Ω load, AC coupling) Maximum \pm 10 V
Impedance	50 Ω , AC coupling
Reference frequency	10 MHz \pm 0.1 MHz
Connector	Rear panel BNC connector

Table A-42: Function Generator (FG)

Characteristics	Description																		
Operation Mode	Continuous mode only																		
Waveform Shape	Sine, Triangle, Square, Ramp, Pulse, DC																		
Frequency	1.000 Hz to 400.0 MHz																		
Amplitude																			
Range	0.020 V _{p-p} to 2.000 V _{p-p} , into a 50 Ω load (OPTION02 : 0.5 V _{p-p} to 1.0 V _{p-p} , into a 50 Ω load)																		
Resolution	1 mV																		
Offset (except option 02)																			
Range	-0.500 V to +0.500 V, into a 50 Ω load																		
Resolution	1 mV																		
DC Level (except option 02)	DC waveform only																		
Range	-0.500 V to +0.500 V, into a 50 Ω load																		
Resolution	1 mV																		
Polarity	Normal, Inverted																		
Duty																			
Range	0.1 % to 99.9 %																		
Resolution	<table border="0"> <tr> <td>Frequency</td> <td>Resolution</td> </tr> <tr> <td>1.000 Hz to 4.000 MHz</td> <td>0.1 %</td> </tr> <tr> <td>4.001 MHz to 20.00 MHz</td> <td>0.5 %</td> </tr> <tr> <td>20.01 MHz to 40.00 MHz</td> <td>1.0 %</td> </tr> <tr> <td>40.01 MHz to 80.00 MHz</td> <td>2.0 %</td> </tr> <tr> <td>80.01 MHz to 100.0 MHz</td> <td>2.5 %</td> </tr> <tr> <td>100.1 MHz to 160.0 MHz</td> <td>4.0 %</td> </tr> <tr> <td>160.1 MHz to 200.0 MHz</td> <td>5.0 %</td> </tr> <tr> <td>200.1 MHz to 400.0 MHz</td> <td>10.0 %</td> </tr> </table>	Frequency	Resolution	1.000 Hz to 4.000 MHz	0.1 %	4.001 MHz to 20.00 MHz	0.5 %	20.01 MHz to 40.00 MHz	1.0 %	40.01 MHz to 80.00 MHz	2.0 %	80.01 MHz to 100.0 MHz	2.5 %	100.1 MHz to 160.0 MHz	4.0 %	160.1 MHz to 200.0 MHz	5.0 %	200.1 MHz to 400.0 MHz	10.0 %
Frequency	Resolution																		
1.000 Hz to 4.000 MHz	0.1 %																		
4.001 MHz to 20.00 MHz	0.5 %																		
20.01 MHz to 40.00 MHz	1.0 %																		
40.01 MHz to 80.00 MHz	2.0 %																		
80.01 MHz to 100.0 MHz	2.5 %																		
100.1 MHz to 160.0 MHz	4.0 %																		
160.1 MHz to 200.0 MHz	5.0 %																		
200.1 MHz to 400.0 MHz	10.0 %																		
Marker Out																			
Pulse Width																			
Mrker1	Hi : 0 % to 20 % of 1 waveform period Lo : 20% to 100 % of 1 waveform period																		
Marker2	Hi : 0 % to 50 % of 1 waveform period Lo : 50 % to 100 % of 1 waveform period Hi : 0 % to 52 % of 1 waveform period Lo : 52 % to 100 % of 1 waveform period at frequency range is 100.1MHz to 160.0MHz																		
Level																			
Hi	2.0 V min into a 50 Ω load																		
Lo	0 V max into a 50 Ω load																		

Table A-43: Display

Characteristics	Description
Display	
Display area	Horizontal: 130.6 mm (5.14 in) Vertical: 97.0 mm (3.81 in)
Resolution	640 (H) × 480 (V) pixels
Size	16 cm (6.4 in.) diag. LCD

Table A-44: AC line power

Characteristics	Description
Rating voltage	100 VAC to 240 VAC, CAT II
Voltage range	90 VAC to 250 VAC
Frequency range	48 Hz to 63 Hz
Maximum consumption	220 VA
Maximum current	5 A
Fuse rating	10 A fast, 250 V, UL 198G (3 AG) 5 A (T), 250 V, IEC 127

Table A-45: Timer

Characteristics	Description
Timer	
Operation time	6 years
Type	Li 3 V, 190 mAh

Table A-46: Interface connectors

Characteristics	Description
GPIB	24-pin, IEEE 488.1 connector on the rear panel
Ethernet	100/10 BASE-T, RJ-45 connector on the rear panel
Keyboard connector	6-pin, mini-DIN connector on the rear panel

Table A-47: Installation requirement

Characteristics	Description
Heat dissipation	
Maximum power	220 VA (maximum line current: 3 A _{rms} , at 50 Hz)
Surge current	30 A (25 °C) peak for equal to or less than 5 line cycles, after the instrument has been turned off for at least 30s
Cooling clearance	Top, 2 cm (0.8 in) Bottom 2 cm (0.8 in) <i>NOTE: The feet on the bottom provide the required clearance when set on a flat surface.</i>
	Sides 15 cm (6 in)
	Rear 7.5 cm (3 in)

Table A-48: Environmental

Characteristics	Description
Atmospherics	
Temperature	
Operating	+10 °C to +40 °C
Non-operating	-20 °C to +60 °C
Relative humidity	
Operating	20 % to 80 % (no condensation) Maximum wet-bulb temperature 29.4 °C
Non-operating	5 % to 90 % (no condensation) Maximum wet-bulb temperature 40.0 °C
Altitude	(Hard disk drive restriction)
Operating	Up to 3 km (10 000 ft) Maximum operating temperature decreases 1 °C each 300 m (1 000 ft) above 1.5 km (5 000 ft)
Non-operating	Up to 12 km (40 000 ft)
Dynamics	
Random vibration	
Operating	2.65 m/s ² rms (0.27Grms), from 5 Hz to 500 Hz, 10 minutes
Non-operating	22.36 m/s ² rms (2.28Grms), from 5 Hz to 500 Hz, 10 minutes
Shock	
Non-operating	294 m/s ² (30 G), half-sine, 11 ms duration

Table A-49: Mechanical

Characteristics	Description
Net weight (without package)	14.1 kg (31.1 lb)
Dimensions (without package)	Height 177 mm (6.97 in) 193 mm (7.60 in) with Feet
	Width 424 mm (16.69 in) 433 mm (17.05 in) with Handle
	Length 470 mm (18.50 in) 508 mm (20.00 in) with Rear Feet
Net weight (with package)	24.5 kg (54.0 lb)
Dimensions (with package)	Height 400 mm (15.75 in)
	Width 550 mm (21.65 in)
	Length 700 mm (27.56 in)

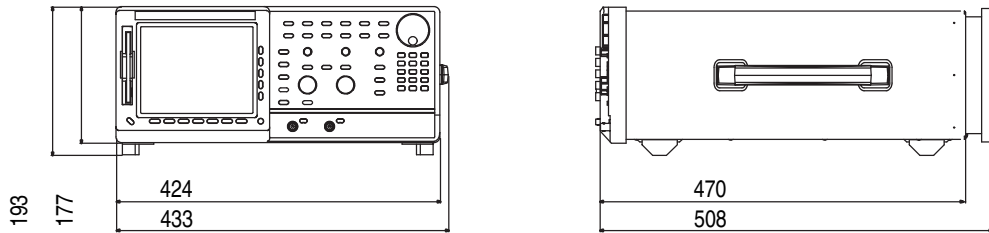

Figure A-12: Dimensions

Certification and Compliances

The certification and compliances for the AWG710 Arbitrary Waveform Generator are listed in Table A-50.

Table A-50: Certifications and compliances

Characteristics	Description																		
EC declaration of conformity	<p>EC council EMC Directive 89/336/EEC, amended by 89/336/EEC; EN61326-1: 1997 Product Family Standard for Electrical Equipment for Measurement, Control, and Laboratory Use-EMC Requirements.</p> <p>Emissions:</p> <table> <tr> <td>EN 55011 Class A</td> <td>Radiated and Conducted emissions</td> </tr> <tr> <td>EN 61000-3-2</td> <td>Power Line Harmonic</td> </tr> </table> <p>Immunity:</p> <table> <tr> <td>EN 61000-4-2</td> <td>Electrostatic Discharge Immunity</td> </tr> <tr> <td>EN 61000-4-3</td> <td>Radiated RF Electromagnetic Field Immunity</td> </tr> <tr> <td>EN 61000-4-4⁶</td> <td>Electrical Fast Transient/Burst Immunity</td> </tr> <tr> <td>EN 61000-4-5</td> <td>Surge Immunity</td> </tr> <tr> <td>EN 61000-4-6</td> <td>Conducted Disturbances Induced by RF Field Immunity</td> </tr> <tr> <td>EN 61000-4-11</td> <td>Power Line Interruption Immunity</td> </tr> </table> <p>Compliance was demonstrated to the following specification as listed in the Official Journal of the European Communities:</p> <p>Low Voltage Directive 73/23/EEC, amended by 93/68/EEC</p> <table> <tr> <td>EN 61010-1/A2:1995</td> <td>Safety requirements for electrical equipment for measurement, control, and laboratory use</td> </tr> </table>	EN 55011 Class A	Radiated and Conducted emissions	EN 61000-3-2	Power Line Harmonic	EN 61000-4-2	Electrostatic Discharge Immunity	EN 61000-4-3	Radiated RF Electromagnetic Field Immunity	EN 61000-4-4 ⁶	Electrical Fast Transient/Burst Immunity	EN 61000-4-5	Surge Immunity	EN 61000-4-6	Conducted Disturbances Induced by RF Field Immunity	EN 61000-4-11	Power Line Interruption Immunity	EN 61010-1/A2:1995	Safety requirements for electrical equipment for measurement, control, and laboratory use
EN 55011 Class A	Radiated and Conducted emissions																		
EN 61000-3-2	Power Line Harmonic																		
EN 61000-4-2	Electrostatic Discharge Immunity																		
EN 61000-4-3	Radiated RF Electromagnetic Field Immunity																		
EN 61000-4-4 ⁶	Electrical Fast Transient/Burst Immunity																		
EN 61000-4-5	Surge Immunity																		
EN 61000-4-6	Conducted Disturbances Induced by RF Field Immunity																		
EN 61000-4-11	Power Line Interruption Immunity																		
EN 61010-1/A2:1995	Safety requirements for electrical equipment for measurement, control, and laboratory use																		
Australia/New Zealand declaration of conformity - EMC	<p>Conforms with the following standards in accordance with the Electromagnetic Compatibility Framework:</p> <p>AS/NZS 2064.1/2</p> <p>Class A radiated and Conducted Emissions</p>																		
Safety	<p>UL3111-1 - Standard for electrical measuring and test equipment</p>																		
Third party certification	CAN/CSA C22.2 No. 1010.1 - Safety requirements for electrical equipment for measurement, control and laboratory use																		
Self declaration	IEC 61010-1/A2:1995 - Safety requirements for electrical equipment for measurement, control, and laboratory use																		
Installation category	Power input — Installation Category II (as defined in IEC 61010-1, Annex J)																		
Pollution degree	Pollution Degree 2 (as defined in IEC 61010-1)																		

⁶ Up to 200 mV_{p-p} noise is allowed on the output during this test.

Table A-51: Installation category and Pollution degree Descriptions

Characteristics	Description	
Installation category	Terminals on this product may have different installation category designations. The installation categories are:	
	<i>Category</i>	<i>Descriptions</i>
	CAT IIIe	Distribution-level mains (usually permanently connected). Equipment at this level is typically in a fixed industrial location
	CAT II	Local-level mains (wall sockets). Equipment at this level includes appliances, portable tools, and similar products. Equipment is usually cord-connected
	CAT I	Secondary (signal level) or battery operated circuits of electronic equipment
Pollution degree	A measure of the contaminants that could occur in the environment around and within a product. Typically the internal environment inside a product is considered to be the same as the external. Products should be used only in the environment for which they are rated.	
	<i>Category</i>	<i>Descriptions</i>
	Pollution Degree 1	No pollution or only dry, nonconductive pollution occurs. Products in this category are generally encapsulated, hermetically sealed, or located in clean rooms.
	Pollution Degree 2	Normally only dry, nonconductive pollution occurs. Occasionally a temporary conductivity that is caused by condensation must be expected. This location is a typical office/home environment. Temporary condensation occurs only when the product is out of service.
	Pollution Degree 3	Conductive pollution, or dry, nonconductive pollution that becomes conductive due to condensation. These are sheltered locations where neither temperature nor humidity is controlled. The area is protected from direct sunshine, rain, or direct wind.
	Pollution Degree 4	Pollution that generates persistent conductivity through conductive dust, rain, or snow. Typical outdoor locations.

Appendix B: Performance Verification (AWG710B)

Two types of Performance Verification procedures can be performed on this product: *Self Tests* and *Performance Tests*. You may not need to perform all of these procedures, depending on what you want to accomplish.

- Verify that the AWG710B Arbitrary Waveform Generator is operating correctly by running the self tests which begin on page B-2.

Advantages: These procedures require minimal time to perform, require no additional equipment, and test the internal hardware of the AWG710B Arbitrary Waveform Generator.

- If a more extensive confirmation of performance is desired, complete the self test, and then do the performance test beginning on page B-6.

Advantages: These procedures add direct checking of warranted specifications. They require more time to perform and suitable test equipment is required. (Refer to *Equipment Required* on page B-7).

Conventions

Throughout these procedures the following conventions apply:

- Each test procedure uses the following general format:

Title of Test

Equipment Required

Prerequisites

Procedure

- Each procedure consists of as many steps, substeps, and subparts as required to do the test. Steps, substeps, and subparts are sequenced as follows:

1. First Step

- a. First Substep

- First Subpart

- Second Subpart

- b. Second Substep

2. Second Step

- Instructions for menu selection use the following format: **front-panel BUTTON**→**Main Menu Button**→**Side Menu Button**. For example, Push **UTILITY**→**System**→**Reset to Factory**→**OK**
- The name of the button or knob appears in boldface type:
Push **EDIT**; then **Drive...**, push **Floppy** side button and use the knob to select **SINE.WFM** from the file list.

Self Tests

The *Self Tests* use internal routines to confirm basic functionality and proper adjustment. No test equipment is required to do these test procedures.

The self tests include internal diagnostics to verify that the instrument passes the internal circuit tests, and calibration routines to check and adjust the instrument internal calibration constants.

Diagnostics

This procedure uses internal routines to verify that the instrument is operating correctly. No test equipment or hookups are required.

The instrument automatically performs the internal diagnostics when powered on; you can also run the internal diagnostics using the menu selections described in this procedure. The difference between these two methods of initiating the diagnostics is that the menu method does a more detailed memory check than the power-on method.

Equipment required	None
Prerequisites	Power on the instrument and allow a twenty-minute warmup period before doing this procedure.

Confirm that there is no output being performed by verifying that the RUN LED is not on. If the LED is on, push the **RUN** button to turn it off.

Do the following to verify that the instrument passes the internal circuit tests:

Push **UTILITY** (front-panel)→**Diag** (bottom)→**Diagnostic All** (side).

The diagnostic menu is displayed and all tests are selected. Refer to Figure B-1. If All is not displayed, select All using the general purpose knob.

The list on the screen shows the test items and results in the calibration and diagnostics previously made. Select all of the test items shown on the screen or use the general purpose knob to select a single test item that you want to run.

The result of the diagnostics are shown as error code. Pass means that the tests have been made without error. If an error is detected, an error code is displayed.

You can also specify how many times the diagnostic tests are performed. Push the **Cycle** side button and then turn the general purpose knob to select the cycle from 1, 3, 10, 100 or Infinite. When you select Infinite, the tests are repeatedly performed, and are not be terminated until you push the **Abort Diagnostic** side button.

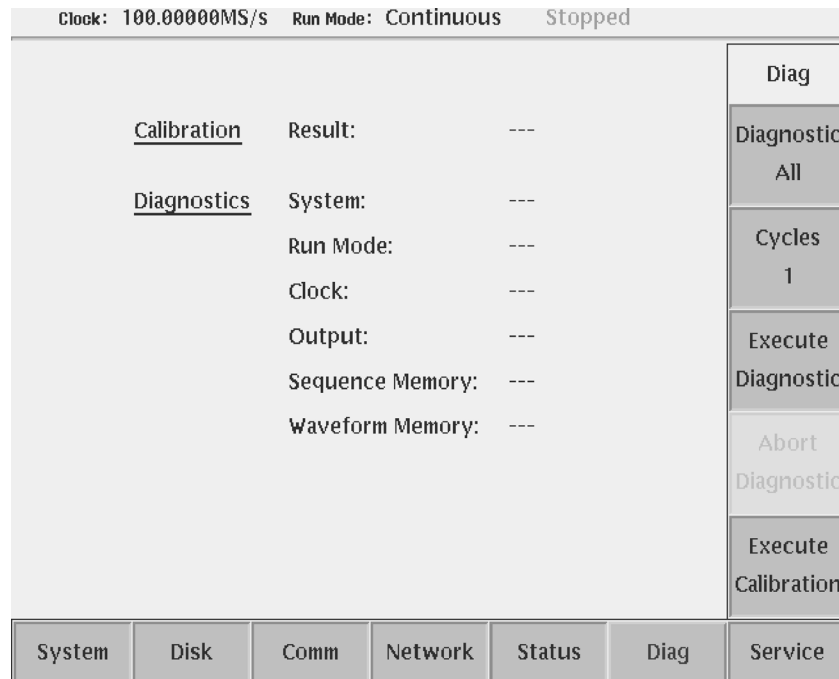

Figure B-1: Diagnostic menu

Do the following to execute all of the AWG710B Arbitrary Waveform Generator diagnostics automatically:

Push the **Execute Diagnostic** side button.

The internal diagnostics do an extensive verification of AWG710B Arbitrary Waveform Generator functions. While this verification progresses, the screen displays the clock icon. When finished, the resulting status appears on the screen.

Verify that no failures are found and reported on–screen. If the diagnostics terminates without error, Pass is displayed instead of the – – –. If a value is displayed, meaning an error is detected, consult a qualified service technician for further assistance.

Push any bottom or menu button (other than **UTILITY**) to exit the diagnostic screen.

Calibration The instrument includes internal calibration routines that check electrical characteristics such as offset, attenuations and filters. Perform calibration to adjust internal calibration constants as necessary. This procedure describes how to do the internal calibration.

Equipment required	None
Prerequisites	Power on the instrument and allow a 20 minute warmup period at an ambient temperature between +20° C and +30° C before doing this procedure.

Confirm that there is no output being performed by verifying that the **RUN LED** is not on. If the LED is on, push the **RUN** button to turn it off.

NOTE. *Some calibration items may fail if you start calibration while output is being performed.*

Do the following steps to verify that the internal adjustments have passed:

1. Push **UTILITY** (front-panel)→**Diag** (bottom)→**Execute Calibration** (side).

This executes the AWG710B Arbitrary Waveform Generator calibration routines automatically.

The internal calibration does an extensive verification of proper AWG710B Arbitrary Waveform Generator functions. While this verification progresses, the message box displaying *Executing Calibration* appear on screen. When finished, the resulting status will appear in the message box as shown in Figure B-2.

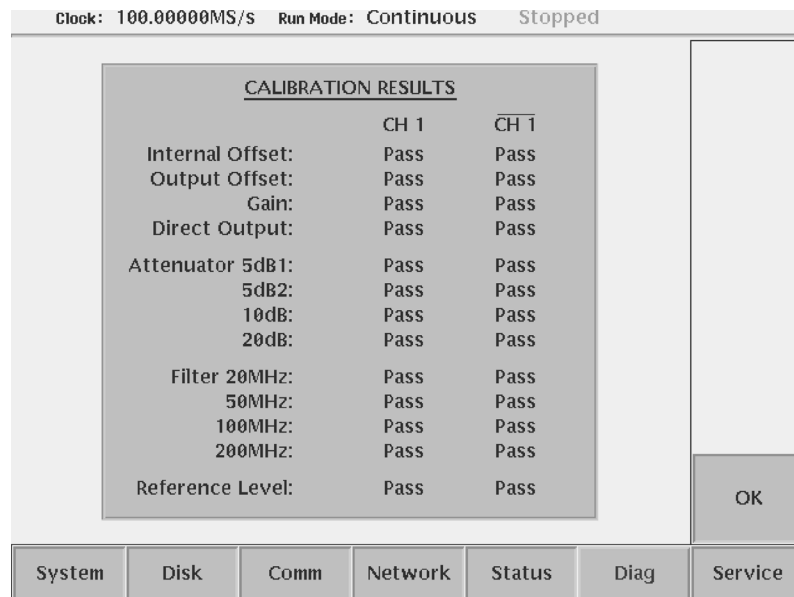

Figure B-2: Calibration result message box (except option 02)

Verify that no failures are found and reported in the message box. If the calibration displays Fail as the result, consult a qualified service technician for further assistance.

2. Push the **OK** side button and then any bottom or menu button (other than the **UTILITY**) to exit the dialog screen.

NOTE. *The calibration data in the memory may be lost if the instrument is powered off while the calibration is executed,*

Performance Tests

This section contains a collection of procedures for checking that the AWG710B Arbitrary Waveform Generator performs as warranted.

The procedures are arranged in eight logical groupings, presented in the following order:

Table B-1: Performance test items

Titles	See (performance verification)	Test items	See (specifications)
Operating mode tests	Page B-13	Continuous, Triggered, and Gated mode normality	Page A-2
Amplitude and offset accuracy tests (normal out)	Page B-19	Amplitude accuracy, and DC offset accuracy	Page A-4
Amplitude, DC offset and rise time accuracy tests (direct DA out)	Page B-23	Amplitude accuracy, DC offset accuracy and Rise time accuracy	Page A-4
Amplitude, DC offset and Rise time accuracy test (Option2)	Page B-27	Amplitude accuracy, DC offset accuracy and Rise time accuracy	Page A-4
Pulse response tests (normal out)	Page B-31	Rise time accuracy	Page A-4
Trigger input tests	Page B-33	Trigger level accuracy, and Trigger function normality	
Event input and enhanced mode tests	Page B-37	External event input function normality, and Event mode normality	
External Clock input and VCO Out tests (AWG710B only)	Page B-37	External Clock input function normality, and VCO Out normality	Page A-6, A-18
VCO Out frequency and 10 MHz reference input tests (AWG710B only)	Page B-48	VCO Out frequency and Reference input normality accuracy	Page A-3
Marker output tests	Page B-50	Marker output level accuracy	Page A-5
Synchronous operation tests (AWG710B only)	Page B-50	Synchronous operation normality	Page A-5

The performance tests check all of the characteristics that are designated as checked in *Appendix A: Specifications*. (The characteristic items that must be checked are listed with the check mark (✓) in *Appendix A: Specifications*).

NOTE. *These procedures extend the confidence level provided by the basic procedures described on page B-2. The basic procedures should be done first, and then these procedures performed if desired.*

Prerequisites The tests in this section comprise an extensive, valid confirmation of performance and functionality when the following requirements are met:

- The cabinet must be installed on the instrument.
- You must have performed and passed the procedures under *Self Tests*, found on page B-2.
- The waveform generator must have been recently adjusted at an ambient temperature between +20° C and +30° C, must have been operating for a warm-up period of at least 20 minutes, and must be operating at an ambient temperature between +10° C and +40° C.

Refer to *Conventions* on page B-1 for more information.

Equipment Required These procedures use external, traceable signal sources to directly check warranted characteristics. Table B-2 lists the required equipment used to complete the performance tests.

Table B-2: Test equipment

Item number and description	Minimum requirements	Example (recommended)	Purpose
1. Frequency Counter (for AWG710B)	1 MHz to 3 GHz, Accuracy: < 0.2 ppm	Anritsu MF1603A	Checks reference input. VCO Out test
1. Frequency Counter (for AWG710)	1 MHz to 100 MHz, Accuracy: < 0.2 ppm	Anritsu MF1603A	Checks reference input. VCO Out test
2. Digital multi meter	DC volts range: 0.05 V to 10 V, Accuracy: ± 0.1 %	Fluke 8842A	Measures voltage. Used in multiple procedures.
3. Oscilloscope	Bandwidth: > 500 MHz, 1 MΩ and 50 Ω inputs	Tektronix TDS784D	Checks output signals. Used in multiple procedures.
4. Oscilloscope	Bandwidth: > 6 GHz, Rise time: < 58.3 ps, 50 Ω input	Tektronix TDS820	Checks pulse response.
5. Function Generator	Output voltage: -5 V to +5 V, Frequency accuracy: < 0.01 %	Tektronix AFG310	Generates external input signals. Used in multiple input signal test procedures.
5. Signal Generator (for AWG710B)	Output voltage: -5 V to +5 V, Frequency accuracy: < 0.01 %	Agilent 8648B	Generates external input signals. Used in multiple input signal test procedures.
6. SMA Coaxial Cable (4 required:for AWG710B)	50 Ω, male to male SMA connectors	Tektronix part number 174-1427-00	Signal interconnection
7. BNC Coaxial Cable (3 required)	50 Ω, male to male BNC connectors	Tektronix part number 012-0482-00	Signal interconnection
8. Adapter (2 required)	SMA (male) to BNC (female), 50 Ω	Tektronix part number 015-0554-00	Signal interconnection
9. Adapter	SMA (female) to BNC (male), 50 Ω	Tektronix part number 015-0572-00	Signal interconnection

Table B-2: Test equipment (cont.)

Item number and description	Minimum requirements	Example (recommended)	Purpose
10. Adapter	SMA (female) to N(male), 50 Ω	Tektronix part number SMA(fe)-SMA(fe)015-101 2-00 + SMA(ma)-N(ma) 015-0369-00	Signal interconnection
11. BNC-T Connector	BNC (male) to BNC (female) to BNC (female)	Tektronix part number 103-0030-00	Signal interconnection
12. Dual-Banana Connector	BNC (female) to dual banana	Tektronix part number 103-0090-00	Signal interconnection
13. SMA Terminator (2 required)	50 Ω, SMA (male)	Tektronix part number 015-1022-01	Signal termination
14. Precision Terminator	50 Ω, 0.1 %, BNC	Tektronix part number 011-0129-00	Signal termination
15. Performance check disks	Must use example listed	Supplied with the product, Tektronix part number 062-A273-00 for AWG710 063-3721-00 for AWG710B	Used to provide waveform files.
16. Ground closure (loopback cable) with 9-pin, D-type connector		Custom, See Figure B-3.	Used for event mode test.

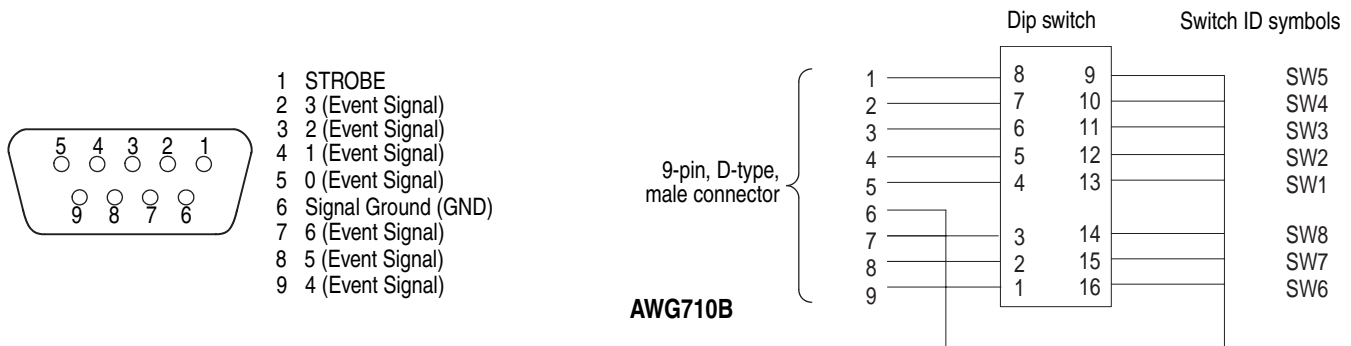
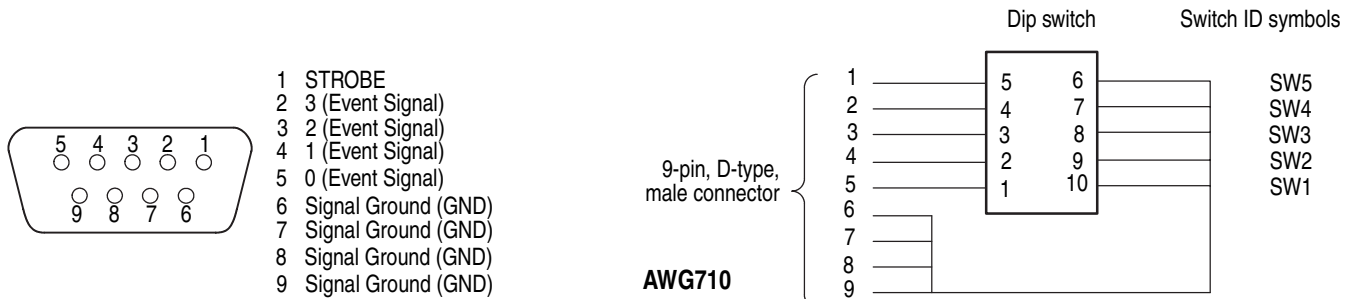

Figure B-3: EVENT IN connector pins and signals and ground closure connector

Loading Files The following steps explain how to load files from the Performance Check/Adjustment disk into waveform memory and/or sequence memory.

1. Insert the disk into the AWG710B Arbitrary Waveform Generator floppy disk drive.
2. Select **SETUP** (front)→**Waveform/Sequence** (bottom)→**Load...** (side)→**Drive...** (side).

The Select Drive dialog box appears as show in Figure B-4.

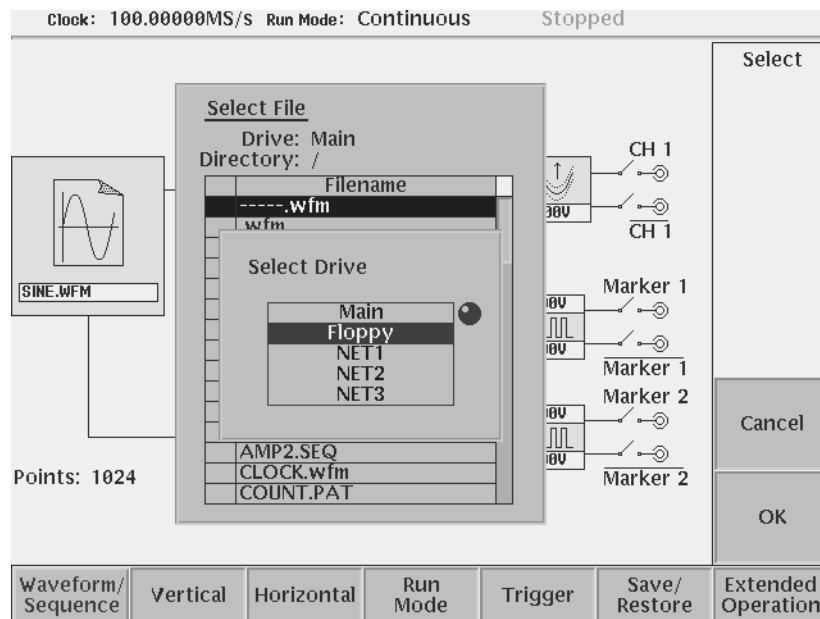

Figure B-4: Loading file; selecting storage drive

3. Select **Floppy** from the dialog box with the general purpose knob, and then push the **OK** side button.

The Select Drive dialog box disappears, and the files in the floppy disk are listed on the Select File dialog box.

4. Use the general purpose knob to select a file to be loaded from the dialog box, and then push the **OK** side button.

The waveform or sequence you selected is loaded into the instrument, and the instrument is also setup with the parameters stored in that file.

5. Remove the floppy disk from the floppy drive if the floppy disk is no longer needed.
6. Push any bottom button or menu button to exit the menu.

NOTE. *The floppy disk file list displayed on the screen does not automatically update when you replace the diskette with another diskette. To update the file list, reselect the floppy disk drive.*

Performance Check/Adjustment Files

Table B-3 lists the sequence and waveform files on the Performance Check/Adjustment disk that are used in these performance tests, the AWG710B Arbitrary Waveform Generator front-panel settings that each file sets up, and the performance test that uses each file.

NOTE. The files on the Performance Check disk are locked (the files are marked by the icon  in the file list), so the data in these files cannot be changed unless the lock is opened.

Table B-3: Waveforms and sequences in performance check disk







No.	File name	EDIT menu		SETUP menu				Marker setup	Usage
		Form	Points	Clock	Filter	Ampl	Offset		
1	MODE.WFM		1000	4 GHz	Through	1 V	0 V	Marker 1,2: 0 to 499: High, 500 to 999: Low	Run mode, Trigger level, Internal trigger accuracy
2	PULSE.WFM		1000	100 MHz	Through	1 V	0 V		Pulse response
3	AMP1.SEQ								Amplitude accuracy (Normal out), Marker
4	AMP2.SEQ								Amplitude accuracy (Direct out)
5	DC_P.WFM (AMPx.SEQ) ¹		1000	100 MHz	Through	1 V	0 V		Amplitude accuracy
6	DC_M.WFM (AMPx.SEQ) ¹		1000	100 MHz	Through	1 V	0 V		Amplitude accuracy
7	DC0.WFM (AMP2.SEQ)		1000	100 MHz	Through	1 V	0 V		Amplitude accuracy
8	OFFSET.WFM		1000	100 MHz	Through	20 mV	0 V		Offset accuracy
9	TRIG.WFM		1000	1 MHz	Through	1 V	0 V		Trigger input
10	PT_EVENT7.SEQ (for AWG710B)								Event input
11	PT_STROB7.SEQ (for AWG710B)								Event input

Table B-3: Waveforms and sequences in performance check disk (cont.)

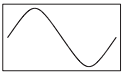
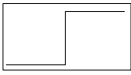
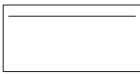
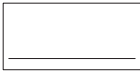
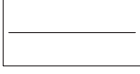
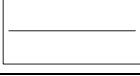
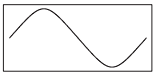
No.	File name	EDIT menu		SETUP menu				Marker setup	Usage
		Form	Points	Clock	Filter	Ampl	Offset		
12	S1024.WFM (PT_XXXX.SEQ) ²		1024	400 MHz	Through	1 V	0 V		Event input
13	S1024H.WFM (PT_XXXX.SEQ) ²		1024	400 MHz	Through	1 V	0 V		Event input
14	R1024H.WFM (PT_XXXX.SEQ) ²		1024	400 MHz	Through	1 V	0 V		Event input
15	T1024H.WFM (PT_XXXX.SEQ) ²		1024	400 MHz	Through	1 V	0 V		Event input
16	Q1024H.WFM (PT_XXXX.SEQ) ²		1024	400 MHz	Through	1 V	0 V		Event input
17	NULL1024.WFM (PT_XXXX.SEQ) ²		1024	400 MHz	Through	1 V	0 V		Event input

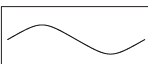
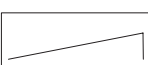
¹ The AMPx.SEQ represents AMP1.SEQ and AMP2.SEQ.

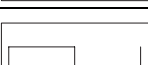
² The PT_XXXX.SEQ represents PT_EVENT7.SEQ and PT_STROB7.SEQ

Operating Mode Tests

The following procedures verify the operation of the Cont, Triggered and Gated modes.

NOTE. When you output signal from the CH1 or $\overline{\text{CH1}}$ OUTPUT, check that the other OUTPUT ($\overline{\text{CH1}}$ or CH1) LED is off. If the other OUTPUT LED is on, push the $\overline{\text{CH1}}$ or CH1 OUT button to turn off the output.

Check Cont Mode

Equipment required	A 50 Ω SMA coaxial cable, a SMA(Female)-BNC(Male) adapter and an oscilloscope (TDS700).
Prerequisites	The AWG710B Arbitrary Waveform Generator must meet the prerequisites listed on page B-7.

Do the following steps to install the test hookup and set the test equipment controls:

1. Use a 50 Ω SMA coaxial cable to connect the AWG710B Arbitrary Waveform Generator CH1 output connector to the oscilloscope CH1 input connector (see Figure B-5).

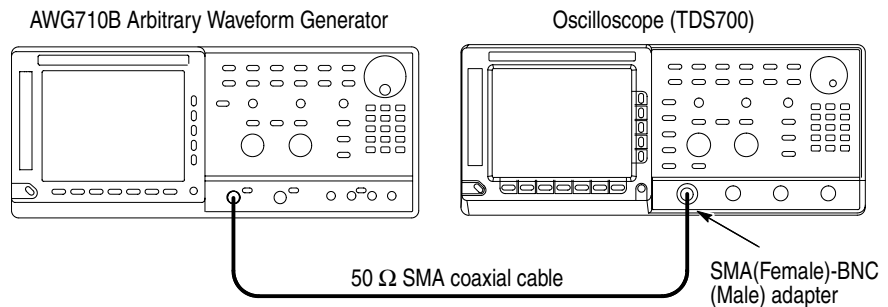

Figure B-5: Cont mode initial test hookup

2. Set the oscilloscope controls as follows:

Vertical	CH1
CH1 coupling.....	DC
CH1 scale	200 mV/div
CH1 input impedance	50 Ω
Horizontal	
Sweep	100 ns/div

Trigger

Source.....	CH1
Coupling	DC
Slope.....	Positive
Level	+100 mV
Mode.....	Auto

Do the following steps to set the AWG710B Arbitrary Waveform Generator controls and to select the waveform file:

1. Push **UTILITY** (front-panel)→**System** (bottom)→**Factory Reset** (side)→**OK** (side).
2. Load the MODE.WFM file.
Refer to *Loading Files* on page B-9 for file loading procedures.
3. Push the **RUN** and **CH1** output buttons.
The LEDs above the RUN button and CH1 output connectors are on.
4. Check that the amplitude of the sine wave displayed on the oscilloscope is 5 vertical divisions and that a waveform of approximately one cycle per 2.5 horizontal divisions is displayed.

Check Triggered Mode

The following table lists the equipment and prerequisites required to check the Triggered mode.

Equipment required	Two 50 Ω BNC coaxial cables, a 50 Ω SMA coaxial cable, a SMA(Fe)–BNC(Ma) adapter, a BNC–T (male to 2 females) adapter, a function generator, and an oscilloscope (TDS700).
Prerequisites	The AWG710B Arbitrary Waveform Generator must meet the prerequisites listed on page B-7.

Do the following steps to install the test hookup and set the test equipment controls:

1. Use a 50 Ω BNC coaxial cable and a BNC–T adapter to connect the function generator output connector to the AWG710B Arbitrary Waveform Generator TRIG IN connector. Refer to Figure B-6.
2. Connect a second 50 Ω BNC coaxial cable to the BNC–T adapter. Connect the opposite end of the coaxial cable to the oscilloscope CH2 input.
3. Use a 50 Ω SMA coaxial cable and SMA(Fe)–BNC(Ma) adapter to connect the AWG710B Arbitrary Waveform Generator CH1 output connector to the oscilloscope CH1 input connector.

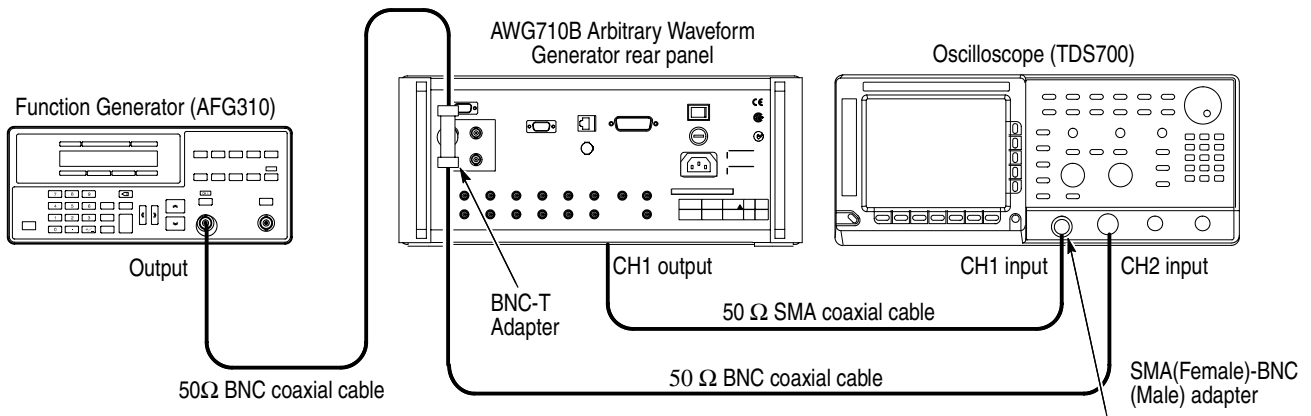

Figure B-6: Triggered mode initial test hookup

4. Set the oscilloscope controls as follows:

Vertical CH1 and CH2	
CH1 and CH2 coupling	DC
CH1 scale	500 mV/div
CH2 scale	2 V/div
CH1 input impedance	50 Ω
CH2 input impedance	1 MΩ
Horizontal	
Sweep	200 ns/div
Trigger	
Source	CH1
Coupling	DC
Slope	Positive
Level	+100 mV
Mode	NORMAL

5. Set the function generator (AFG310) controls as follows:

Function	Square
'Mode	Continuous
Parameters	
Frequency	1 MHz
Amplitude	2.0 V into 50 Ω (4.0 V into 1 MΩ)
Offset	1.0 V into 50 Ω (2.0 V into 1 MΩ)
Output	Off

6. Follow the substeps below to set the AWG710B Arbitrary Waveform Generator controls and to select the waveform file:
 - a. Push **UTILITY** (front-panel)→**System** (bottom)→**Factory Reset** (side)→**OK** (side).
 - b. Push **SETUP** (front-panel)→**Run Mode** (bottom)→**Triggered** (side)
 - c. Load the MODE.WFM file.

Refer to *Loading Files* on page B-9 for file loading procedures.

- d. Push the **RUN** and **CH1** output buttons.

The LEDs above the RUN button and CH1 output connectors are on.

- e. Push the **FORCE TRIGGER** button.

Verify that the oscilloscope displays a one-cycle sine wave when the FORCE TRIGGER button is pushed. You may need to adjust the horizontal position control to see the signal.

7. Follow the substeps below to check the triggered mode with external triggering:
 - a. Turn on the function generator output.
 - b. Verify that the oscilloscope displays a one-cycle sine wave for each trigger supplied by the function generator. See Figure B-7.

Retain the test hookup.

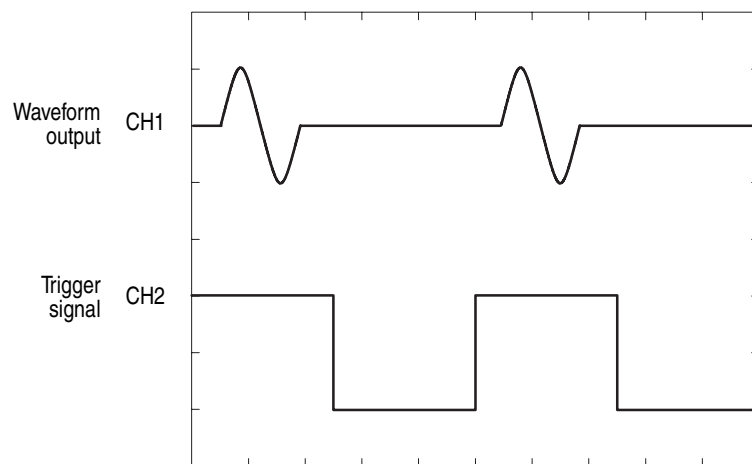

Figure B-7: Relationship between trigger signal and waveform output

Check Gated Mode

Equipment required	Two 50 Ω BNC coaxial cables, a 50 Ω SMA coaxial cable, a SMA(Fe)–BNC(Ma) adapter, a BNC–T (male to 2 females) adapter, a function generator, and an oscilloscope (TDS700).
Prerequisites	The AWG710B Arbitrary Waveform Generator must meet the prerequisites listed on page B-7.

1. Set the oscilloscope controls as follows:

Vertical	CH1 and CH2
CH1 and CH2 coupling	DC
CH1 scale	500 mV/div
CH2 scale	2 V/div
CH1 input impedance	50 Ω
CH2 input impedance	1 MΩ
Horizontal	
Sweep	20 μs/div
Trigger	
Source	CH1
Coupling	DC
Slope	Positive
Level	100 mV
Mode	NORMAL

2. Set the function generator (AFG310) controls as follows:

Function	Square
Mode	Continuous
Parameters	
Frequency	10.1 kHz
Amplitude	2.0 V into 50 Ω (4.0 V into 1 MΩ)
Offset	1.0 V into 50 Ω (2.0 V into 1 MΩ)
Output	Off

3. Follow the substeps below to set the AWG710B Arbitrary Waveform Generator controls and to select the waveform file:

- a.** Push **UTILITY** (front-panel)→**System** (bottom)→**Factory Reset** (side)→**OK** (side).
- b.** Push **SETUP** (front-panel)→**Run Mode** (bottom)→**Gated** (side).
- c.** Load the MODE.WFM file.

Refer to *Loading Files* on page B-9 for file loading procedures.

- d.** Push **HORIZONTAL MENU** (front-panel)→ **Clock** (side).

e. Push **1, 0, 0** and **M** (SHIFT+7) keys in this order or turn the general purpose knob to set the internal clock frequency to 100 MHz.

f. Push the **RUN** and **CH1** output buttons.

The LEDs above the **RUN** button and **CH1** output connector are on.

g. Push the **FORCE TRIGGER** button.

Verify that the oscilloscope displays sine waves while the **FORCE TRIGGER** button is pushed and that the output stops when the Force Trigger button is released.

4. Follow the substeps below to check the gated mode with the gate signal:

a. Set the oscilloscope trigger source to CH2 and change the trigger level to 1 V.

b. Turn on the function generator output.

c. Verify that the oscilloscope displays sine waves while the function generator gate signal amplitude is High level. See Figure B-8.

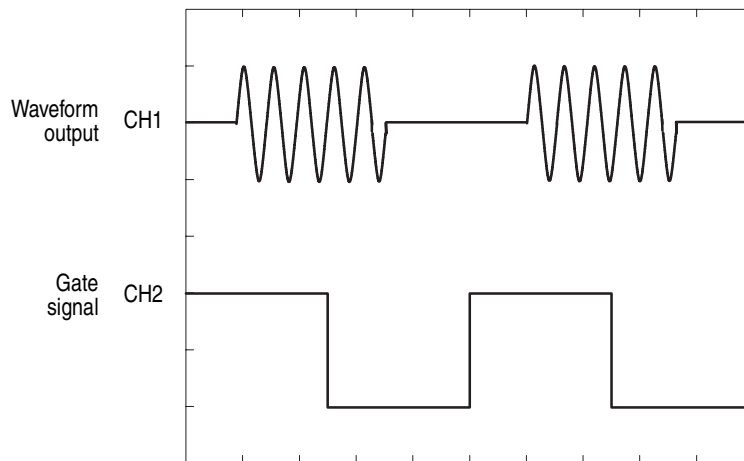

Figure B-8: Relationship between gate signal and waveform output

d. Push **SETUP** (front-panel)→**Trigger** (bottom)→**Negative** (side).

This changes the AWG710B Arbitrary Waveform Generator trigger polarity to negative.

5. Verify that the oscilloscope displays sine waves while the function generator gate signal amplitude is Low level.

6. Turn off the function generator output and disconnect from the oscilloscope.

Amplitude and Offset Accuracy Tests (Normal Out), (except option 02)

These procedures check the accuracy of the amplitude and offset outputs of the AWG710B Arbitrary Waveform Generator.

NOTE. The amplitude and offset accuracy checks are structured as a continuous test. The next test uses the control settings from the previous test and uses the next step in the sequence file.

NOTE. When you output signal from the $\overline{CH1}$ or CH1 OUTPUT, check that the other OUTPUT ($\overline{CH1}$ or CH1) LED is off. If the other OUTPUT LED is on, push the $\overline{CH1}$ or CH1 OUT button to turn off the output.

Check Amplitude Accuracy

Equipment required	A 50 Ω BNC coaxial cable, a 50 Ω precision terminator, a SMA(Ma)–BNC(Fe) adapters, BNC (female)–to–dual banana adapter, and a digital multimeter (DMM).
Prerequisites	The AWG710B Arbitrary Waveform Generator must meet the prerequisites listed on page B-7.

Do the following steps to install the test hookup and set the test equipment controls:

1. Use a 50 Ω BNC coaxial cable, a SMA(Ma)–BNC(Fe) adapter, a 50 Ω precision terminator, and a BNC–to–dual banana adapter to connect the AWG710B Arbitrary Waveform Generator CH1 output to the DMM input connector (see Figure B-9).

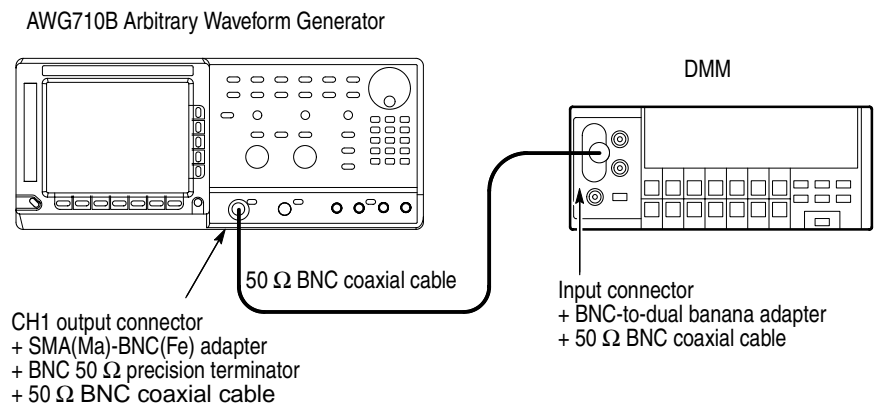

Figure B-9: Amplitude accuracy initial test hookup

2. Set the DMM controls as follows:

Mode.....	VDC
Range.....	Auto
Input.....	Front

3. Follow the substeps below to set the AWG710B Arbitrary Waveform Generator controls and to select the sequence file:

- a. Push **UTILITY** (front-panel)→**System** (bottom)→**Factory Reset** (side)→**OK** (side).
- b. Push **SETUP** (front-panel)→**Run Mode** (bottom)→**Enhanced** (side).

The AWG710B Arbitrary Waveform Generator is set to enhanced mode.

- c. Load the AMP1.SEQ file.

Refer to *Loading Files* on page B-9 for file loading procedures.

4. Push the **RUN** and **CH1** output buttons.

The LEDs above the RUN button and CH1 output connector are on.

5. Do the following substeps to set the AWG710B Arbitrary Waveform Generator amplitude and confirm the offset setting:

- a. Push **VERTICAL MENU** (front-panel)→**Amplitude** (side).
- b. Push **0**, **.**, **0**, **2** and **ENTER** keys in this order or turn the general purpose knob to set the amplitude to 0.020 V.
- c. Verify that the offset setting display on the Offset side button is 0.000 V.

If the offset display is not set correctly, push the **Offset** side button, and push **0** and then **ENTER** key.

6. Do the following substeps to check the amplitude accuracy of a 20 mV amplitude setting:

- a. Write the DMM reading as a positive voltage.
- b. Push the **FORCE EVENT** button.
- c. Write the DMM reading as a negative voltage.
- d. Verify that the positive minus negative voltages fall within $20\text{ mV} \pm 2.4\text{ mV}$.
- e. Push **0**, **.**, **2** and **ENTER** keys in this order or turn the general purpose knob to set the amplitude to 0.200 V.

7. Do the following to check the amplitude accuracy of 200 mV amplitude setting:

- a. Push the **FORCE EVENT** button.
- b. Write the DMM reading as a positive voltage.

- c. Push the **FORCE EVENT** button.
 - d. Write the DMM reading as a negative voltage.
 - e. Verify that the positive minus negative voltages fall within $200 \text{ mV} \pm 6 \text{ mV}$.
 - f. Push the **2** and the **ENTER** keys in this order or turn the general purpose knob to set the amplitude to 2 V.
8. Do the following substeps to check the amplitude accuracy of 2 V amplitude setting:
 - a. Push the **FORCE EVENT** button.
 - b. Write the DMM reading as a positive voltage.
 - c. Push the **FORCE EVENT** button.
 - d. Write the DMM reading as a negative voltage.
 - e. Check that the positive minus negative voltages fall within $2 \text{ V} \pm 0.042 \text{ V}$.
 9. Do the following substeps to change the connection to check the $\overline{\text{CH1}}$:
 - a. Push the **CH1** output button.
 - b. Disconnect the adapter, terminator and cable from the **CH1** output connector.
 - c. Connect the adapter, terminator, and the cable (removed in step b) to the $\overline{\text{CH1}}$ output connector.
 - d. Push the $\overline{\text{CH1}}$ output button to turn on the $\overline{\text{CH1}}$ LED.
 10. Repeat the *Check Amplitude Accuracy* procedure for the AWG710B Arbitrary Waveform Generator $\overline{\text{CH1}}$ beginning on page B-19.
 11. Reconnect the test hookup on the $\overline{\text{CH1}}$ output to the CH1 output. Retain the control settings.

Check Offset Accuracy

The following procedure checks the Offset Accuracy.

1. Use the test hookup and settings from previous check on page B-19 and B-19.
2. Follow the substeps below to set the AWG710B Arbitrary Waveform Generator controls and to select the sequence file:
 - a. Push **UTILITY** (front-panel)→**System** (bottom)→**Factory Reset** (side)→**OK** (side).
 - b. Load the OFFSET.WFM file.
Refer to *Loading Files* on page B-9 for file loading procedures.
 - c. Push **VERTICAL MENU** (front-panel)→**Amplitude** (side).

- d. Push **0**, **.**, **0**, **2** and **ENTER** keys in this order or turn the general purpose knob to set the amplitude to 0.020 V.
 3. Push the **RUN** and **CH1** output buttons.
The LEDs above the RUN button and CH1 output connector are on.
 4. Do the following substeps to set the AWG710B Arbitrary Waveform Generator offset:
 - a. Push the **Offset** side button.
 - b. Push **0** and **ENTER** keys in this order.
 - c. Verify that the reading on the DMM falls within $0\text{ V} \pm 10\text{ mV}$.
 - d. Push **0**, **.**, **5** and **ENTER** keys in this order to change the AWG710B Arbitrary Waveform Generator offset to 0.5 V.
 - e. Verify that the reading on the DMM falls within $0.5\text{ V} \pm 0.0175\text{ V}$.
 - f. Push **-**, **0**, **.**, **5** and **ENTER** keys in this order to change the AWG710B Arbitrary Waveform Generator offset to -0.5 V .
 - g. Check that the reading on the DMM falls within $-0.5\text{ V} \pm 0.0175\text{ V}$.
 5. Do the following substeps to change the connection to check the $\overline{\text{CH1}}$:
 - a. Push the **CH1** output button.
 - b. Disconnect the adapter, terminator and cable from the **CH1** output connector.
 - c. Connect the adapter, terminator, and cable (removed in step b) to the $\overline{\text{CH1}}$ output connector.
 - d. Push the $\overline{\text{CH1}}$ output button to turn on the $\overline{\text{CH1}}$ LED.
 6. Repeat the *Check Offset Accuracy* procedure for the AWG710B Arbitrary Waveform Generator $\overline{\text{CH1}}$.
 7. Push the $\overline{\text{CH1}}$ output button to turn off the $\overline{\text{CH1}}$ LED.
 8. Disconnect the test hookup from the $\overline{\text{CH1}}$ output connector.

Amplitude, Offset Accuracy and Rise Time Tests (Direct DA Out), (except option 02)

These procedures check the accuracy of the WG710B Arbitrary Waveform Generator direct waveform outputs; amplitude and offset.

Check Amplitude and DC Offset

Equipment required	A 50 Ω BNC coaxial cable, a 50 Ω precision terminator, an SMA(Ma)–BNC(Fe) adapter, BNC (female)–to–dual banana adapter, and a digital multimeter (DMM).
Prerequisites	The AWG710B Arbitrary Waveform Generator must meet the prerequisites listed on page B-7.

Do the following steps to install the test hookup and set the test equipment controls:

1. Use a 50 Ω BNC coaxial cable, an SMA(Ma)–BNC(Fe) adapter, a 50 Ω precision terminator, and a BNC–to–dual banana adapter to connect the AWG710B Arbitrary Waveform Generator **CH1** output to the DMM input connector (see Figure B-10).

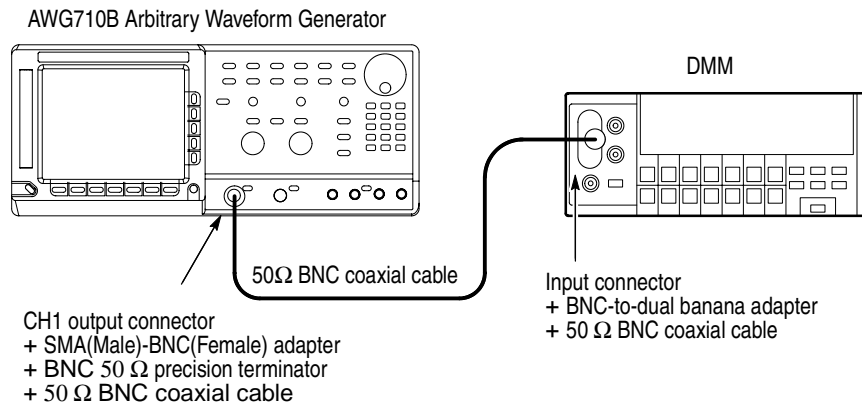

Figure B-10: Direct DA output amplitude accuracy initial test hookup

2. Set the DMM controls as follows:

Mode VDC
 Range 2 V
 Input Front

3. Push **UTILITY** (front–panel)→**System** (bottom)→**Factory Reset** (side)→**OK** (side).

4. Push **SETUP** (front-panel)→**Run Mode** (bottom)→**Enhanced** (side).
The AWG710B Arbitrary Waveform Generator is set to enhanced mode.
5. Push **VERTICAL MENU** (front-panel)→**Output** (side)→**Direct** (side).
6. Load the AMP2.SEQ file.
Refer to *Loading Files* on page B-9 for file loading procedures.
7. Push the **RUN** and **CH1** output buttons.
The LEDs above the RUN button and CH1 output connector are on.
8. Do the following substeps to check the direct DA amplitude accuracy of 1 V amplitude setting:
 - a. Write the DMM reading as a positive voltage.
 - b. Push the **FORCE EVENT** button.
 - c. Write the DMM reading as a negative voltage.
 - d. Verify that the positive minus negative voltages fall within $1.0\text{ V} \pm 0.022\text{ V}$.
 - e. Push **VERTICAL MENU** (front-panel)→**Amplitude** (side).
 - f. Push **0**, **,0**, **2** and **ENTER** keys in this order or turn the general purpose knob to set the amplitude to 0.020 V.
9. Do the following to check the direct DA amplitude accuracy of 20 mV amplitude setting:
 - a. Push the **FORCE EVENT** button twice.
 - b. Write the DMM reading as a positive voltage.
 - c. Push the **FORCE EVENT** button.
 - d. Write the DMM reading as a negative voltage.
 - e. Verify that the positive minus negative voltages fall within $20\text{ mV} \pm 2.4\text{ mV}$.
10. Follow the substeps below to check the DC offset:
 - a. Push the **FORCE EVENT** button.
 - b. Verify that the reading on the DMM falls within $0\text{ V} \pm 10\text{ mV}$.
11. Do the following substeps to change the connection to check the $\overline{\text{CH1}}$:
 - a. Push the **CH1** output button.
 - b. Disconnect the adapter, terminator and cable from the **CH1** output connector.
 - c. Connect the adapter, terminator, and cable (removed in step b) to the $\overline{\text{CH1}}$ output connector.

- d. Push the **CH1** output button to turn on the **CH1** LED.
 - e. Push the **FORCE EVENT** button.
12. Repeat steps 8 through step 10 for the AWG710B Arbitrary Waveform Generator **CH1**.
 13. Push the **CH1** output button to turn off the **CH1** LED.
 14. Push the **RUN** button to turn off the RUN LED.
 15. Disconnect the DMM.

Check Pulse Rise Time

Equipment required	A 50 Ω SMA coaxial cable and an oscilloscope (TDS820).
Prerequisites	The AWG710B Arbitrary Waveform Generator must meet the prerequisites listed on page B-7.

Do the following steps to install the test hookup and set the test equipment controls:

1. Use the 50 Ω SMA coaxial cable to connect the AWG710B Arbitrary Waveform Generator CH1 output connector to the oscilloscope CH1 input connector (see Figure B-11).

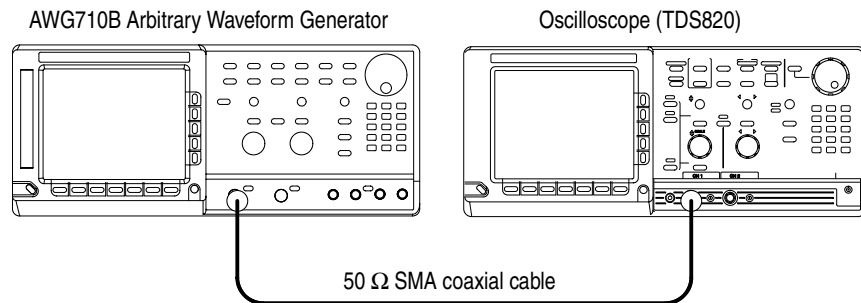



Figure B-11: Direct DA output pulse rise time initial test hookup

2. Set the oscilloscope controls as follows:

Vertical	CH1
CH1 coupling.....	DC if applicable
CH1 scale	100 mV/div
CH1 input impedance	50 Ω
Horizontal	CH1
Sweep	500 ps/div

Trigger

Source.....	CH1
Slope.....	
Level.....	0 V
Mode.....	Auto

NOTE. *The pulse rise time tests use the AWG710B Arbitrary Waveform Generators control settings that have been used in the amplitude and DC offset tests. Do not initialize the AWG710B Arbitrary Waveform Generator controls.*

3. Load the PULSE.WFM file.
Refer to *Loading Files* on page B-9 for file loading procedures.
4. Push **SETUP** (front-panel)→**Run Mode** (bottom)→**Continuous** (side).
The AWG710B Arbitrary Waveform Generator is set to the Continuous mode.
5. Change the AWG710B Arbitrary Waveform Generator controls as follows:
 - a. Push **VERTICAL MENU** (bottom)→**Amplitude** (side).
 - b. Push **0**, **.**, **5** and **ENTER** keys in this order or turn the general purpose knob to set the amplitude to 0.5 V.
 - c. Verify that the Direct DA out is set. If not, push **Output** (side)→**Direct** (side).
6. Push the **RUN** and **CH1** output buttons.
The LEDs above the RUN button and CH1 output connectors are on.
7. Verify that the rise time of the pulse waveform displayed on the oscilloscope is equal to or less than 280 ps.
8. Do the following substeps to change the connection to check the $\overline{\text{CH1}}$:
 - a. Push the **CH1** output button.
 - b. Disconnect the cable from the CH1 output connector.
 - c. Connect the cable to the $\overline{\text{CH1}}$ output connector.
 - d. Push the $\overline{\text{CH1}}$ output button to turn on the $\overline{\text{CH1}}$ LED.
9. Repeat step 7 to verify the rise time for the AWG710B Arbitrary Waveform Generator $\overline{\text{CH1}}$.
10. Push the $\overline{\text{CH1}}$ output button to turn off the $\overline{\text{CH1}}$ LED.

Amplitude, Offset Accuracy and Rise Time Tests (for option 02)

These procedures check the accuracy of the AWG710B Arbitrary Waveform Generator option02 outputs; amplitude and offset.

Check Amplitude and DC Offset

Equipment required	A 50 Ω BNC coaxial cable, a 50 Ω precision terminator, an SMA(Ma)-BNC(Fe) adapter, BNC (female)-to-dual banana adapter, and a digital multimeter (DMM).
Prerequisites	The AWG710B option 02 Arbitrary Waveform Generator must meet the prerequisites listed on page B-7.

Do the following steps to install the test hookup and set the test equipment controls:

1. Use a 50 Ω BNC coaxial cable, an SMA(Ma)-BNC(Fe) adapter, a 50 Ω precision terminator, and a BNC-to-dual banana adapter to connect the AWG710B Arbitrary Waveform Generator **CH1** output to the DMM input connector (see Figure B-12).

AWG710B option 02 Arbitrary Waveform Generator

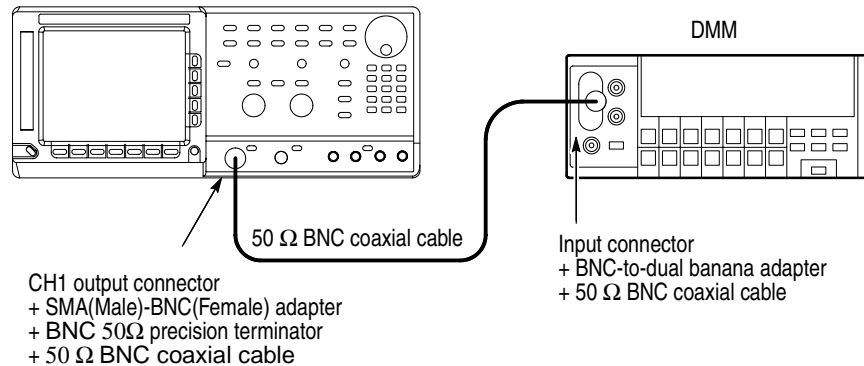

Figure B-12: Option02 output amplitude accuracy initial test hookup

2. Set the DMM controls as follows:

Mode VDC
 Range 2 V
 Input Front

3. Push **UTILITY** (front-panel)→**System** (bottom)→**Factory Reset** (side)→**OK** (side).

4. Push **SETUP** (front-panel)→**Run Mode** (bottom)→**Enhanced** (side).
The AWG710B Arbitrary Waveform Generator is set to enhanced mode.
5. Load the AMP2.SEQ file.
Refer to *Loading Files* on page B-9 for file loading procedures.
6. Push the **RUN** and **CH1** output buttons.
The LEDs above the RUN button and CH1 output connector are on.
7. Do the following substeps to check the option02 amplitude accuracy of 1 V amplitude setting:
 - a. Write the DMM reading as a positive voltage.
 - b. Push the **FORCE EVENT** button.
 - c. Write the DMM reading as a negative voltage.
 - d. Verify that the positive minus negative voltages fall within $1.0\text{ V} \pm 0.022\text{ V}$.
 - e. Push **VERTICAL MENU** (front-panel)→**Amplitude** (side).
 - f. Push **0**, **.**, **5** and **ENTER** keys in this order or turn the general purpose knob to set the amplitude to 0.500 V.
8. Do the following to check the option02 amplitude accuracy of 500 mV amplitude setting:
 - a. Push the **FORCE EVENT** button twice.
 - b. Write the DMM reading as a positive voltage.
 - c. Push the **FORCE EVENT** button.
 - d. Write the DMM reading as a negative voltage.
 - e. Verify that the positive minus negative voltages fall within $500\text{ mV} \pm 12\text{ mV}$.
9. Follow the substeps below to check the DC offset:
 - a. Push the **FORCE EVENT** button.
 - b. Verify that the reading on the DMM falls within $0\text{ V} \pm 10\text{ mV}$.
10. Do the following substeps to change the connection to check the $\overline{\text{CH1}}$:
 - a. Push the **CH1** output button.
 - b. Disconnect the adapter, terminator and cable from the **CH1** output connector.
 - c. Connect the adapter, terminator, and cable (removed in step b) to the $\overline{\text{CH1}}$ output connector.
 - d. Push the $\overline{\text{CH1}}$ output button to turn on the $\overline{\text{CH1}}$ LED.

- e. Push the **FORCE EVENT** button.
- 11. Repeat steps 7 through step 9 for the AWG710B Arbitrary Waveform Generator **CH1**.
- 12. Push the **CH1** output button to turn off the **CH1** LED.
- 13. Push the **RUN** button to turn off the RUN LED.
- 14. Disconnect the DMM.

Check Pulse Rise Time

Equipment required	A 50 Ω SMA coaxial cable and an oscilloscope (TDS820).
Prerequisites	The AWG710B Arbitrary Waveform Generator must meet the prerequisites listed on page B-7.

Do the following steps to install the test hookup and set the test equipment controls:

- 1. Use the 50 Ω SMA coaxial cable to connect the AWG710B Arbitrary Waveform Generator CH1 output connector to the oscilloscope CH1 input connector (see Figure B-13).

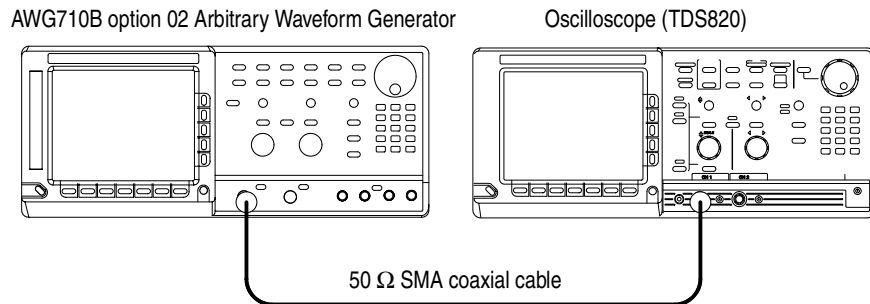



Figure B-13: Optipn02 output pulse rise time initial test hookup

- 2. Set the oscilloscope controls as follows:

Vertical CH1
 CH1 coupling..... DC if applicable
 CH1 scale 200 mV/div
 CH1 input impedance 50 Ω
 Horizontal
 Sweep 200 ps/div

Trigger

Source.....	CH1
Slope.....	
Level.....	0 V
Mode.....	Auto

NOTE. *The pulse rise time tests use the AWG710B Arbitrary Waveform Generators control settings that have been used in the amplitude and DC offset tests. Do not initialize the AWG710B Arbitrary Waveform Generator controls.*

3. Load the PULSE.WFM file.
Refer to *Loading Files* on page B-9 for file loading procedures.
4. Push **SETUP** (front-panel)→**Run Mode** (bottom)→**Continuous** (side).
The AWG710B Arbitrary Waveform Generator is set to the Continuous mode.
5. Change the AWG710B Arbitrary Waveform Generator controls as follows:
 - a. Push **VERTICAL MENU** (bottom)→**Amplitude** (side).
 - b. Push **1** and **ENTER** keys in this order or turn the general purpose knob to set the amplitude to 1 V.
6. Push the **RUN** and **CH1** output buttons.
The LEDs above the RUN button and CH1 output connectors are on.
7. Verify that the rise time of the pulse waveform displayed on the oscilloscope is equal to or less than 175 ps.
8. Do the following substeps to change the connection to check the $\overline{\text{CH1}}$:
 - a. Push the **CH1** output button.
 - b. Disconnect the cable from the CH1 output connector.
 - c. Connect the cable to the $\overline{\text{CH1}}$ output connector.
 - d. Push the $\overline{\text{CH1}}$ output button to turn on the $\overline{\text{CH1}}$ LED.
9. Repeat step 7 to verify the rise time for the AWG710B Arbitrary Waveform Generator $\overline{\text{CH1}}$.
10. Push the $\overline{\text{CH1}}$ output button to turn off the $\overline{\text{CH1}}$ LED.

Pulse Response Tests (Normal Out), (except option 02)

This procedure checks the pulse response characteristics of the AWG710B Arbitrary Waveform Generator output waveforms at amplitudes of 1 V.

Equipment required	A 50 Ω SMA coaxial cable and an oscilloscope (TDS820).
Prerequisites	The AWG710B Arbitrary Waveform Generator must meet the prerequisites listed on page B-7.

Do the following steps to install the test hookup and set the test equipment controls:

1. Use the 50 Ω SMA coaxial cable to connect the AWG710B Arbitrary Waveform Generator CH1 output connector to the oscilloscope CH1 input connector (see Figure B-14).

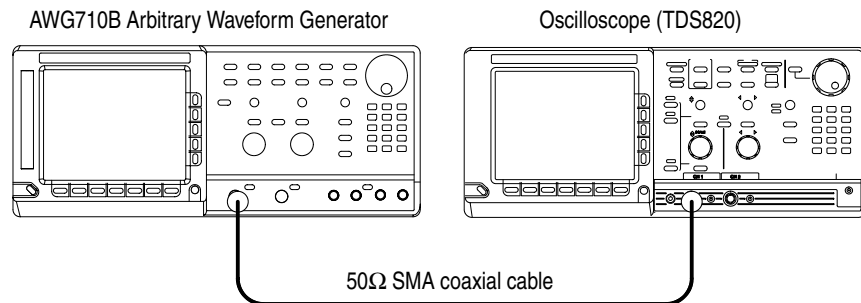

Figure B-14: Pulse response initial test hookup

2. Set the oscilloscope controls as follows:

VerticalCH1	
CH1 coupling.....	DC if applicable
CH1 scale	200 mV/div
Horizontal	
Sweep	500 ps/div
Trigger	
Source.....	CH1
Slope.....	Positive
Level	0 V
Mode.....	Auto

3. Push **UTILITY** (front-panel)→**System** (bottom)→**Factory Reset** (side)→**OK** (side).

4. Load the PULSE.WFM file.
Refer to *Loading Files* on page B-9 for file loading procedures.
5. Push the **RUN** and **CH1** output buttons.
The LEDs above the RUN button and CH1 output connector are on.
6. Verify the pulse response at 1 V amplitude.
 - a. Verify that the rise time of the waveform displayed on the oscilloscope from 10% to 90% point is equal to or less than 480 ps.
7. Do the following substeps to change the connection to check the $\overline{\text{CH1}}$:
 - a. Push the **CH1** output button.
 - b. Disconnect the cable from the CH1 output connector.
 - c. Connect the cable to the $\overline{\text{CH1}}$ output connector.
 - d. Push the $\overline{\text{CH1}}$ output button to turn on the $\overline{\text{CH1}}$ LED.
8. Repeat the *Check Pulse Response procedure* for the AWG710B Arbitrary Waveform Generator $\overline{\text{CH1}}$.
9. Push the $\overline{\text{CH1}}$ output button to turn off the $\overline{\text{CH1}}$ LED.
10. Disconnect the oscilloscope.

Trigger Input Tests

These procedures check the trigger level accuracy of the AWG710B Arbitrary Waveform Generator.

Equipment required	Two 50 Ω BNC coaxial cables, a 50 Ω SMA coaxial cable, a SMA(Fe)–BNC(Ma) adapter, a BNC–T (male to 2 females) adapter, a function generator, and an oscilloscope (TDS700).
Prerequisites	The AWG710B Arbitrary Waveform Generator must meet the prerequisites listed on page B-7.

Do the following steps to install the test hookup and set the test equipment controls:

1. Use a 50 Ω SMA coaxial cable and an SMA(Fe)–BNC(Fe) adapter to connect the AWG710B Arbitrary Waveform Generator CH1 output connector to the oscilloscope CH1 input connector.
2. Use a BNC coaxial cable to connect the function generator to the BNC–T adapter which goes to the Trigger Input on the AWG710B. Connect a 50 Ω BNC coaxial cable to the BNC–T adapter. Connect the opposite end of the BNC cable to the CH2 input on the oscilloscope.

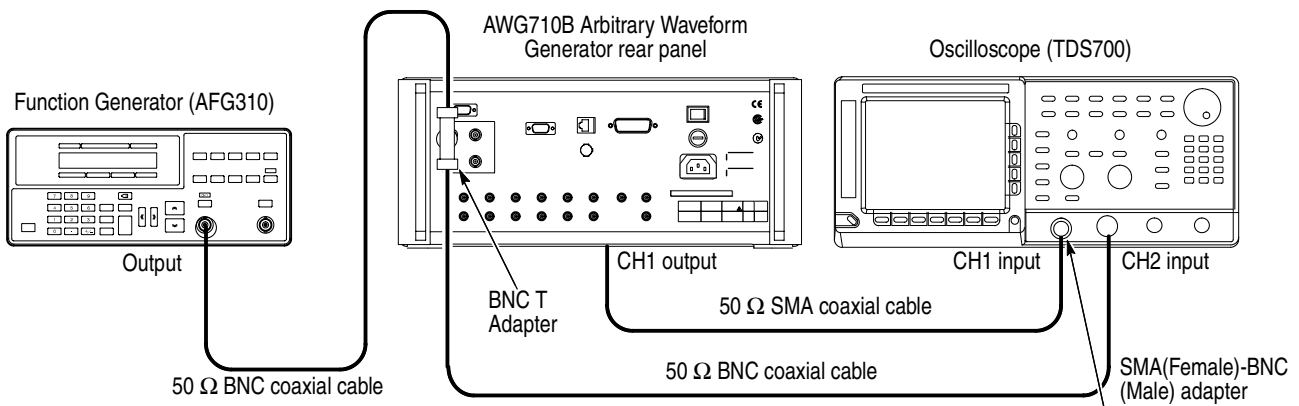

Figure B-15: Trigger input initial test hookup

3. Set the oscilloscope controls as follows:

Vertical	CH1 and CH2
CH1 and CH2 coupling	DC
CH1 scale	500 mV/div
CH2 scale	2 V/div

CH1 input impedance	50 Ω
CH2 input impedance	1 M Ω
Horizontal	
Sweep	1 ms/div
Trigger	
Source	CH1
Coupling	DC
Slope	Positive
Level	+100 mV
Mode	Auto

- a. Set the function generator controls as follows:

Function	DC
Mode	Continuous
Output	Off

- b. Push **UTILITY** (front-panel)→**System** (bottom)→**Factory Reset** (side)→**OK** (side).
- c. Push **SETUP** (front-panel)→**Run Mode** (bottom)→**Gated** (side).
- d. Load the TRIG.WFM file.

Refer to *Loading Files* on page B-9 for file loading procedures.

4. Push the **RUN** and **CH1 OUT** buttons.

The LEDs above the RUN button and CH1 output connector are on.

5. Set the trigger level to 5 V by the following substeps below:

- a. Push **SETUP** (front-panel)→**Trigger** (bottom)→**Level** (side).
- b. Push **5** and **ENTER** keys in this order.

6. Set the trigger input signal level to 4.65 V by the following substeps below:

- a. Turn on the function generator output.
- b. Select offset by pressing the **OFFSET** button of function generator.
- c. Set the DC waveform high level to 4.65 V by using cursor keys.
- d. Check that no waveform is displayed on the oscilloscope as shown in Figure B-16.

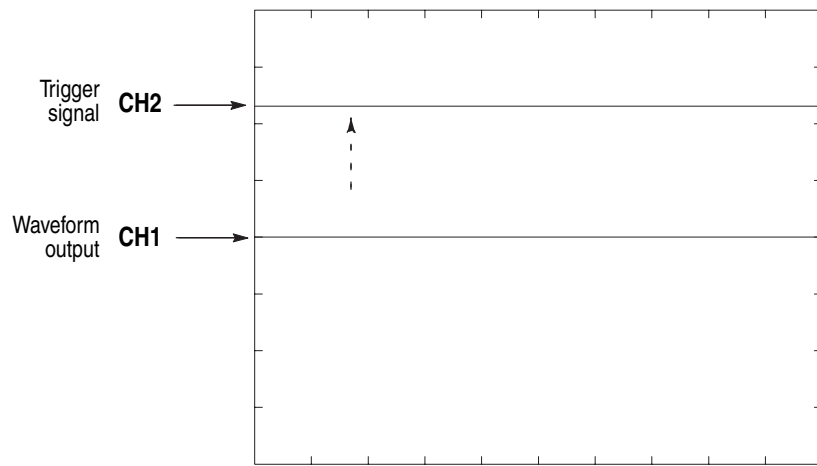

Figure B-16: Trigger signal and waveform output (+5 V check 1)

- e. Change the pulse waveform high level to 5.35 V by using cursor keys.
- f. Check that sine waves are displayed on the oscilloscope as shown in Figure B-7.

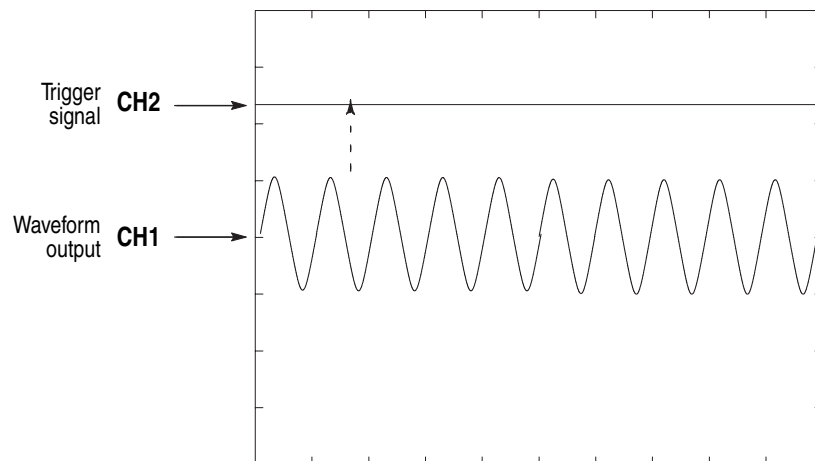

Figure B-17: Trigger signal and waveform output (+5 V check 2)

7. Follow the substeps below to check trigger level accuracy at -5 V:
 - a. Push **-**, **5** and **ENTER** keys in this order.
 - b. Set the DC waveform low level of function generator to -5.35 V by using cursor keys.

- c. Check that no waveform is being displayed on the oscilloscope as shown in Figure B-18.

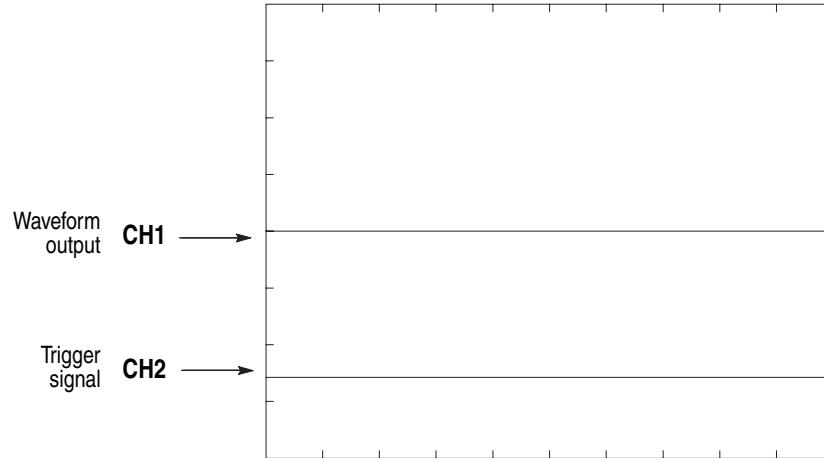

Figure B-18: Trigger signal and waveform output (-5 V check 1)

- d. Change the pulse waveform low level of function generator to -4.65 V by using cursor keys.
- e. Check that sine waves are displayed on the oscilloscope as shown in Figure B-19.

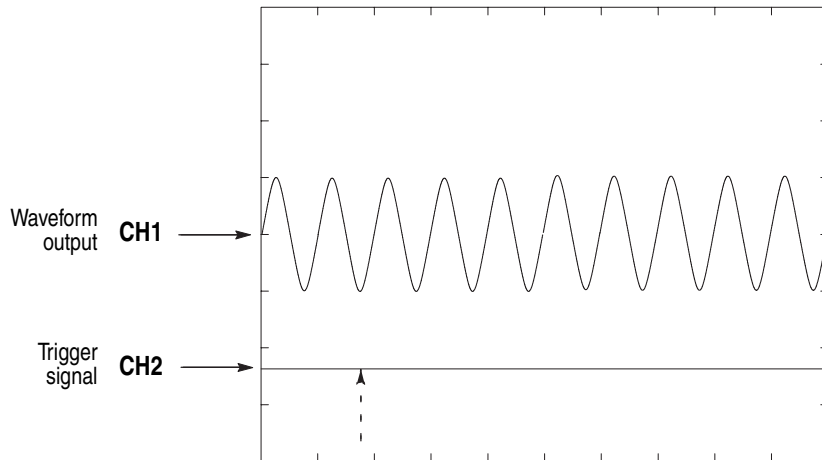

Figure B-19: Trigger signal and waveform output (-5 V check 2)

- 8. Push the **RUN** button and the CH1 button to turn off the RUN LED.
- 9. Turn off the function generator output, disconnect the function generator.

Event Input and Enhanced Mode Tests

These procedures check the event input signals and enhanced mode operation.

NOTE. The event input check with strobe off and the strobe input check are structured as a continuous test. After Check Event Input with Strobe Off, the next test uses the connections and oscilloscope settings from the previous test.

Check Event Input with Strobe Off

Equipment required	A 50 Ω SMA coaxial cable, a SMA(Fe)–BNC(Ma) adapter an oscilloscope (TDS700), and custom–made ground closure. See Figure B-3 for the connections.
Prerequisites	The AWG710B Arbitrary Waveform Generator must meet the prerequisites listed on page B-7.

Do the following steps to install the test hookup and set the test equipment controls:

1. Use a 50 Ω SMA coaxial cable and a SMA(Fe)–BNC(Fe) adapter to connect the AWG710 Arbitrary Waveform Generator **CH1** output connector to the oscilloscope CH1 input connector (see Figure B-20).

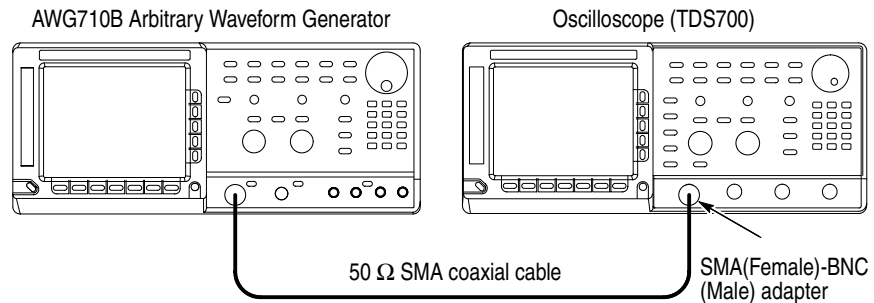

Figure B-20: Event input and enhanced mode initial test hookup

2. Connect the ground closure to the EVENT IN connector on the AWG710B Arbitrary Waveform Generator rear panel.

3. Set the oscilloscope controls as follows:

Vertical	CH1
CH1 coupling.....	DC
CH1 scale	200 mV/div
CH1 input impedance	50 Ω
Horizontal	
Sweep.....	500 ns/div or 400 ns/div
Trigger	
Source.....	CH1
Coupling	DC
Slope.....	Positive
Level	+100 mV
Mode.....	Auto

4. Set all the switches of the ground closure to open.

5. Follow the substeps below to set the AWG710B Arbitrary Waveform Generator controls and select the sequence file:

- a. Push **UTILITY** (front-panel)→**System** (bottom)→**Factory Reset** (side)→**OK** (side).
- b. Load the PT_EVENT.SEQ file.

Refer to *Loading Files* on page B-9 for file loading procedures.

- c. Push **SETUP** (front-panel)→**Run Mode** (bottom)→**Enhanced** (side) to set the enhanced mode.

6. Push the **RUN** and **CH1 OUT** buttons.

The LEDs above the RUN button and CH1 output connector are on.

7. Check the EVENT IN connector pin 0 input:

- a. Verify that a waveform displayed on the oscilloscope has the same amplitude as shown in Figure B-21.

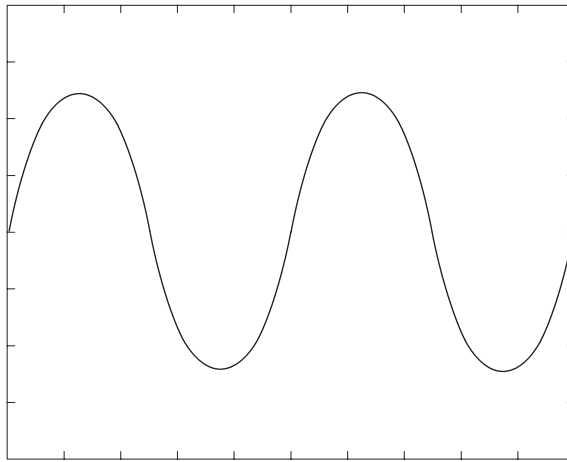

Figure B-21: Waveform while all ground disclosure switches are open

- b.** Close the SW1 of the ground closure to generate an event signal on the EVENT IN connector pin 0.
- c.** Verify that the oscilloscope displays the waveform as shown in Figure B-22 and that the waveform amplitude is the half size of Figure B-21.

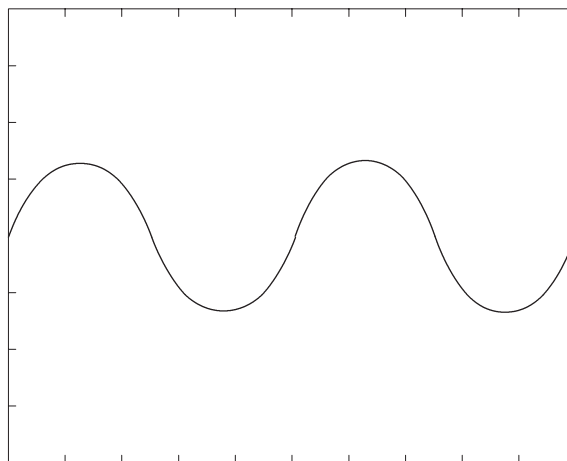

Figure B-22: Waveform output when the SW1 is closed

- d.** Open SW1 of the ground closure to degenerate the event signal.
 - e.** Verify that the oscilloscope displays the waveform in Figure B-21.
- 8.** Check the EVENT IN connector pin 1 input:

- a. Close SW2 of the ground closure to generate an event signal on the EVENT IN connector pin 1.
- b. Verify that the oscilloscope displays the waveform as shown in Figure B-23.

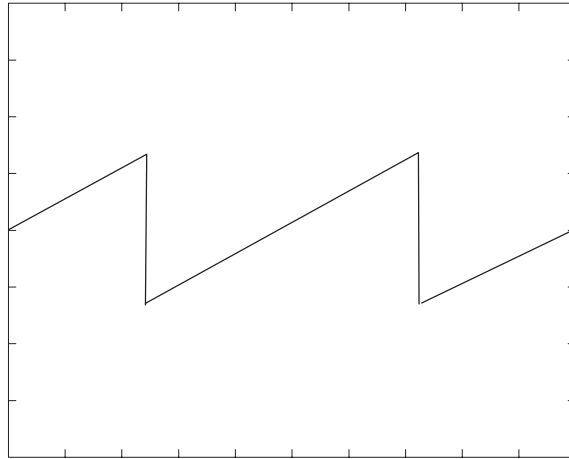

Figure B-23: Waveform output when SW2 is closed

- c. Open the SW2 of the ground closure to degenerate the event signal.
 - d. Verify that the oscilloscope displays the waveform shown in Figure B-21.
9. Check the EVENT IN connector pin 2 input:
- a. Close SW3 of the ground closure to generate an event signal on the EVENT IN connector pin 2.
 - b. Verify that the oscilloscope displays the waveform shown in Figure B-24.

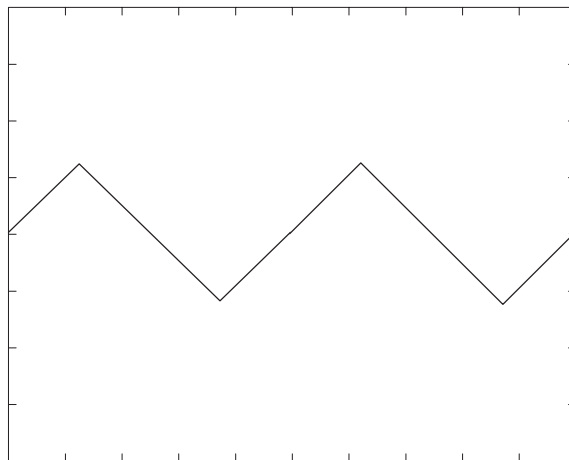

Figure B-24: Waveform output when the SW3 is closed

- c. Open SW3 of the ground closure to degenerate the event signal.
 - d. Verify that the oscilloscope displays the waveform in Figure B-21.
- 10.** Check the EVENT IN connector pin 3 input:
- a. Close the SW4 of the ground closure to generate an event signal on the EVENT IN connector pin 3.
 - b. Verify that the oscilloscope displays the waveform shown in Figure B-25.

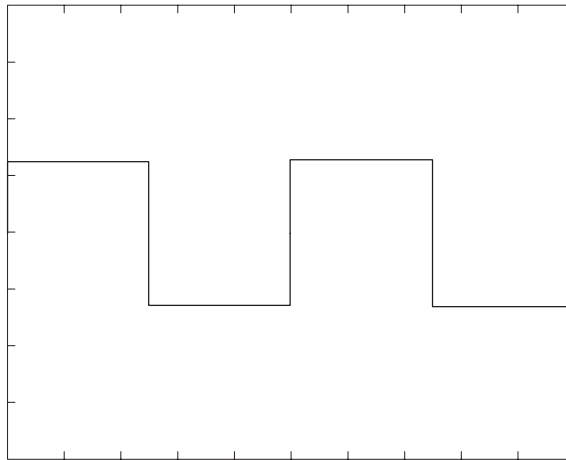

Figure B-25: Waveform output when SW4 is closed

- c. Open SW4 of the ground closure to degenerate the event signal.
 - d. Verify that the oscilloscope displays the waveform in Figure B-21.
- 11.** Check the EVENT IN connector pin 4 input:
- a. Close the SW6 of the ground closure to generate an event signal on the EVENT IN connector pin 4.

- b. Verify that the oscilloscope displays the waveform shown in Figure B-26 and that the waveform cycle is the half of Figure B-21.

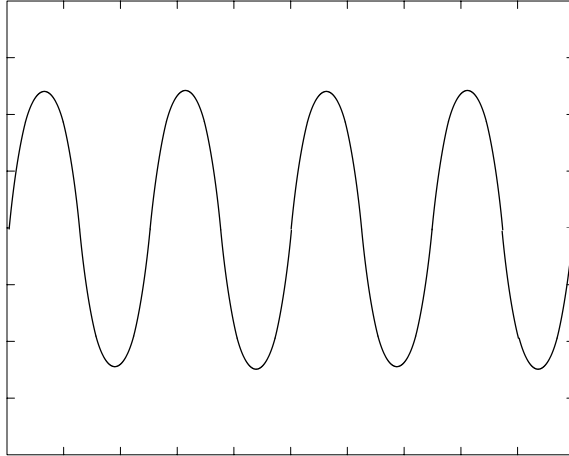

Figure B-26: Waveform output when SW6 is closed

- c. Open SW6 of the ground closure to degenerate the event signal.
 - d. Verify that the oscilloscope displays the waveform in Figure B-21.
- 12. Check the EVENT IN connector pin 5 input:**
- a. Close the SW7 of the ground closure to generate an event signal on the EVENT IN connector pin 5.
 - b. Verify that the oscilloscope displays the waveform shown in Figure B-27.

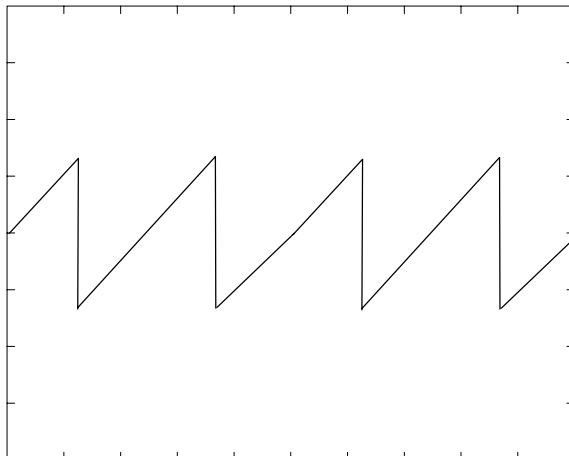

Figure B-27: Waveform output when SW7 is closed

- c. Open SW7 of the ground closure to degenerate the event signal.

- d. Verify that the oscilloscope displays the waveform in Figure B-21.
13. Check the EVENT IN connector pin 6 input:
 - a. Close the SW8 of the ground closure to generate an event signal on the EVENT IN connector pin 6.
 - b. Verify that the oscilloscope displays the waveform shown in Figure B-27.

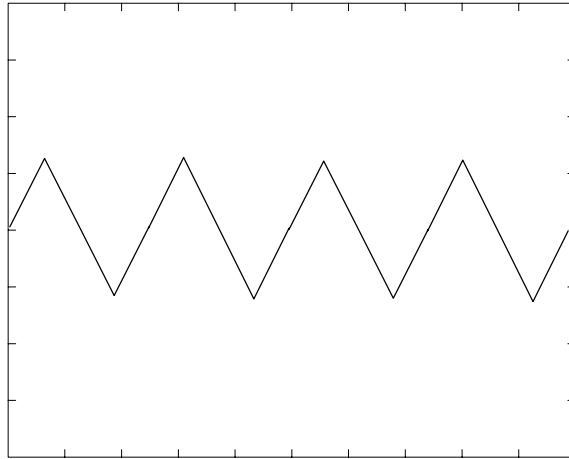

Figure B-28: Waveform output when SW8 is closed

- c. Open SW8 of the ground closure to degenerate the event signal.
- d. Verify that the oscilloscope displays the waveform in Figure B-21.
14. Retain the test hookup and control settings.

Check Strobe Input

Use the test hookup and oscilloscope settings from previous check.

1. Follow the substeps below to set the AWG710B Arbitrary Waveform Generator controls and select the sequence file:
 - a. Push **UTILITY** (front-panel)→**System** (bottom)→**Factory Reset** (side)→**OK** (side).
 - b. Load the PT_STROB7.SEQ file.
Refer to *Loading Files* on page B-9 for file loading procedures.
 - c. Push **SETUP** (front-panel)→**Run Mode** (bottom)→**Enhanced** (side) to set the run mode to enhanced.
2. Push the **RUN** and **CH1 OUT** buttons.
The LEDs above the RUN button and CH1 output connector are on.
3. Check the EVENT IN connector strobe pin input:

- a. Verify that the waveform displayed on the oscilloscope has the same amplitude as shown in Figure B-29.

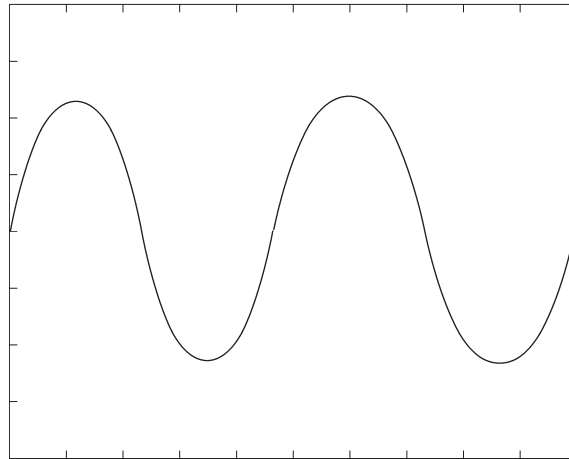

Figure B-29: Initial waveform output

- b. Close SW5 of the ground closure to generate an event signal on the EVENT IN connector strobe pin.
- c. Verify that the oscilloscope displays the DC waveform as shown in Figure B-30.

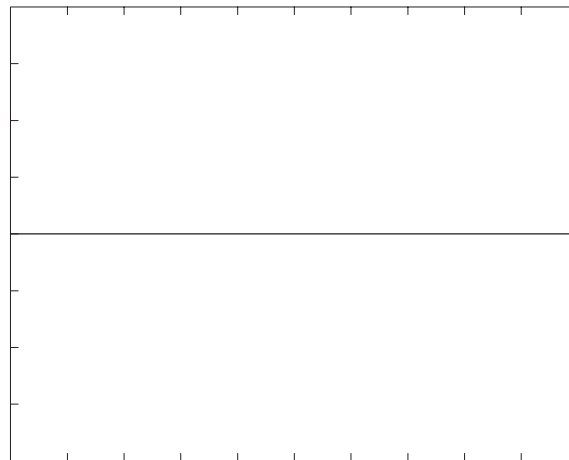

Figure B-30: DC waveform output when the SW5 is closed

- d. Open SW5 of the ground closure to degenerate the strobe signal on the EVENT IN connector strobe pin.
- e. Verify that the DC waveform is displayed on the oscilloscope.

- f. Close SW5 of the ground closure again.
 - g. Verify that the oscilloscope displays the waveform as shown in Figure B-29.
4. Push the **CH1 OUT** button to turn off the CH1 LED.
 5. Disconnect the oscilloscope and ground closure.

External Clock Input and VCO Out Output Tests

These procedures check the external clock input function and the VCO output function of the AWG710B Arbitrary Waveform Generator.

Equipment required	Two 50 Ω SMA coaxial cables, a SMA(Fe)–BNC(Ma) adapter, a signal generator, and an oscilloscope (TDS700).
Prerequisites	The AWG710B Arbitrary Waveform Generator must meet the prerequisites listed on page B-7.

Do the following steps to install the test hookup and set the test equipment controls:

1. Use a 50 Ω SMA coaxial cable and an SMA(Fe)–BNC(Fe) adapter to connect the AWG710B Arbitrary Waveform Generator VCO OUT output connector to the oscilloscope CH1 input connector.
2. Use a 50 Ω SMA coaxial cable to connect the AWG710B Arbitrary Waveform Generator EXT CLOCK IN input connector to the signal generator output connector.

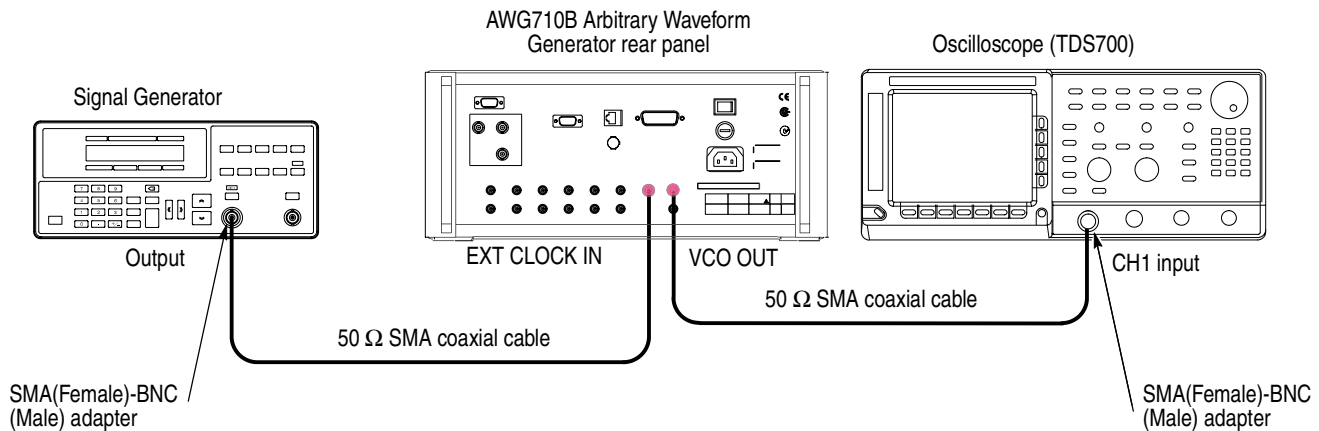

Figure B-31: Trigger input initial test hookup

3. Set the oscilloscope controls as follows:

Vertical	CH1
CH1 coupling	DC
CH1 scale	200 mV/div
CH1 input impedance	50 Ω
Horizontal	
Sweep	2 ns/div

Trigger	
Source.....	CH1
Coupling.....	DC
Slope.....	Positive
Level.....	0 V
Mode.....	Auto

- a. Set the signal generator controls as follows:

Parameter	
Frequency.....	200 MHz
Amplitude.....	1.0 V (50 Ω)
Output.....	On

- b. Push **UTILITY** (front-panel)→**System** (bottom)→**Factory Reset** (side)→**OK** (side).
- c. Load the MODE.WFM file.
- d. Push **SETUP** (front-panel)→**Horizontal** (bottom)→**Clock Src** (side)→**External**.

Refer to *Loading Files* on page B-9 for file loading procedures.

4. Push the **RUN** and **CH1 OUT** buttons.
5. Check that the LEDs above the RUN button and CH1 output connector are on.
6. Check that about 200.00 MS/s is displayed on the Clock field on the left-hand side of the AWG710B display top end.
7. Check that the amplitude of the square wave displayed on the oscilloscope is approximately 400 mV_{p-p} and the period is approximately 5 ns.
8. Disconnect the cable from the VCO OUT connector and connect the cable to the $\overline{\text{VCO OUT}}$ connector.
9. Check that the amplitude of the square wave displayed on the oscilloscope is approximately 400 mV_{p-p} and the period is approximately 5 ns.
10. Disconnect the cable from the $\overline{\text{VCO OUT}}$ connector and connect the cable to the CH1 OUTPUT connector of the AWG710B.
11. Set the Horizontal sweep of the oscilloscope to 2 μ /s/
12. Check that the period of the sine wave displayed on the oscilloscope is approximately 5 μ s.
13. Push the **RUN** button and the CH1 button to turn off the RUN LED.
14. Turn off the function generator output, disconnect the function generator.

VCO OUT Output Frequency and 10 MHz Reference Input Tests

These procedures check the VCO OUT output frequency and the 10 MHz reference input function of the AWG710B Arbitrary Waveform Generator.

Equipment required	A 50 Ω SMA coaxial cable, A 50 Ω BNC coaxial cable, a SMA(Female)-BNC(Male) adapter, a frequency counter, and a function generator.
Prerequisites	The AWG710B Arbitrary Waveform Generator must meet the prerequisites listed on page B-7.

Do the following steps to install the test hookup and set the test equipment controls:

1. Use a 50 Ω SMA coaxial cable and SMA(Female)-BNC(Male) adapter to connect the AWG710B Arbitrary Waveform Generator VCO OUT connector to the input B connector on the frequency counter.
2. Use a 50 Ω BNC coaxial cable to connect the AWG710B Arbitrary Waveform Generator 10 MHz REF IN connector to the function generator output connector (see Figure B-32).

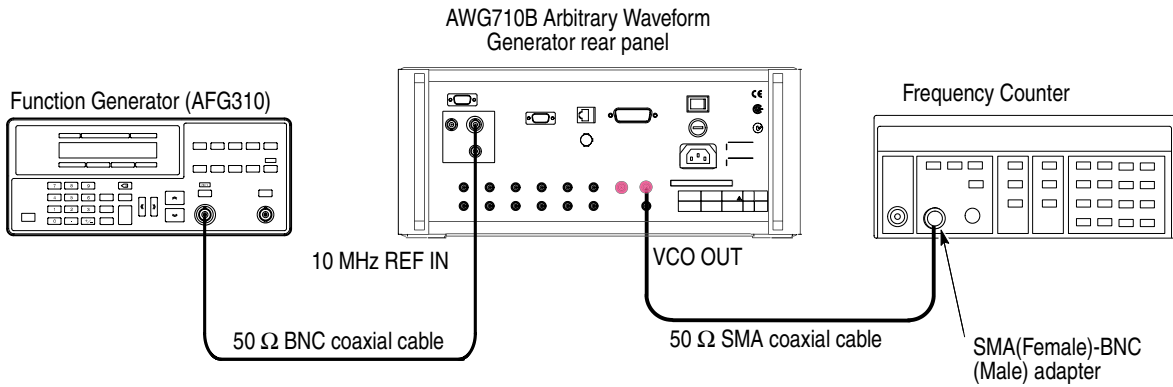

Figure B-32: VCO OUT output frequency and 10 MHz reference input initial test hookup

- a. Set the frequency counter controls as follows:

INPUT A	
Coupling	AC
FUNCTION	B FREQ
Gate time	0.2 s
Trigger Level	0 V

- b. Set the function generator (AFG310) controls:

Function	Square
Mode	Continuous
Parameters	
Frequency	10 MHz
Amplitude	2.0 V into 50 Ω (4.0 V into 1 MΩ)
Offset	0 V
Output	On

**Check VCO OUT
frequency**

1. Follow the substeps below to set the AWG710B Arbitrary Waveform Generator controls and select the waveform file:
 - a. Push **UTILITY** (front-panel)→**System** (bottom)→**Factory Reset** (side)→**OK** (side).
 - b. Load the MODE.WFM file.
Refer to *Loading Files* on page B-9 for file loading procedures.
 - c. Push **HORIZONTAL MENU** (front-panel)→**Clock** (side).
 - d. Push **2**, **.**, **5** and **G** (SHIFT+CLR) keys in this order or turn the general purpose knob to set the internal clock frequency to 2.5 GHz.
2. Push the **RUN** button.
The LED above the RUN button is on.
3. Verify that the frequency counter reading is 2.5 GHz ± 2.5 kHz (using internal reference clock).
4. Retain the test hookup.

**Check 10MHz Reference
Input**

5. Push **HORIZONTAL MENU** (front-panel)→**Clock Ref** (side) so that the AWG710B Arbitrary Waveform Generator reference clock is set to External.
6. Verify that the frequency counter reading is approximately 2.50 GHz (using external reference clock).
7. Change the function generator controls as follows:

Frequency	9.9 MHz
-----------------	---------
8. Check that the frequency counter reading is approximately 2.475 GHz.
9. Turn the function generator output off and disconnect the function generator and frequency counter.

Marker Output Tests

These procedures check the accuracy of the AWG710B Arbitrary Waveform Generator marker output level.

NOTE. Connect a 50Ω SMA terminator to the inverted marker output connector during the marker output tests.

Equipment required	A 50 Ω BNC coaxial cable, a 50 Ω precision terminator, a SMA(Ma)–BNC(Fe) adapters, BNC (female)–to–dual banana adapter, and a digital multimeter (DMM).
Prerequisites	The AWG710B Arbitrary Waveform Generator must meet the prerequisites listed on page B-7.

Do the following steps to install the test hookup and set the test equipment controls:

1. Use a 50 Ω BNC coaxial cable, a SMA(Ma)–BNC(Fe) adapter, a 50 Ω precision terminator, and a BNC–to–dual banana adapter to connect the AWG710B Arbitrary Waveform Generator MARKER 1 OUT to the DMM input connector (see Figure B-33).

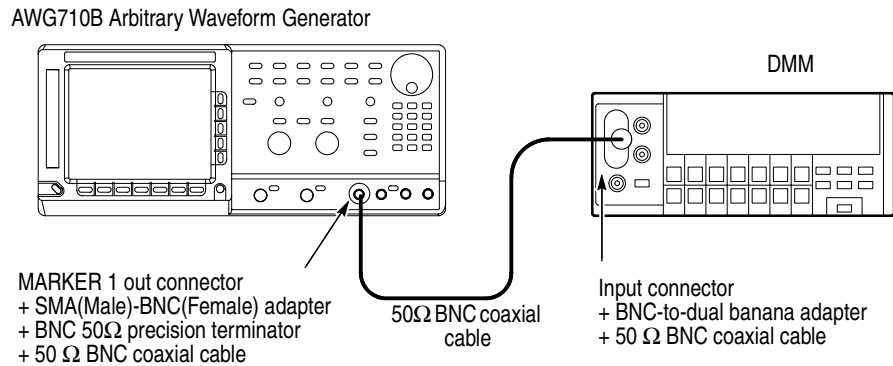

Figure B-33: Marker output initial test hookup

2. Set the DMM controls as follows:

Mode VDC
 Range Auto
 Input Front

3. Follow the substeps below to set the AWG710B Arbitrary Waveform Generator controls and to select the sequence file:

- a. Push **UTILITY** (front-panel)→**System** (bottom)→**Factory Reset** (side)→**OK** (side).
- b. Push **SETUP** (front-panel)→**Run Mode** (bottom)→**Enhanced** (side).
The AWG710B Arbitrary Waveform Generator is set to enhanced mode.
- c. Load the AMP1.SEQ file.
Refer to *Loading Files* on page B-9 for file loading procedures.
4. Push the **RUN** button and **ALL MARKER OUT ON/OFF** button.
The LEDs above the RUN button and ALL MARKER OUT ON/OFF is on.
5. Do the following substeps to set the AWG710B Arbitrary Waveform Generator marker output high level setting:
 - a. Push **VERTICAL MENU** (front-panel)→**Marker...** (side)→**Marker 1 High Level** (side).
 - b. Push **2**, **.**, **4**, **5** and **ENTER** keys in this order or turn the general purpose knob to set the marker level to 2.45 V.
 - c. Verify that the marker 1 high level reading on the DMM screen falls within 2.2275 V through 2.6725 V.
 - d. Push the **FORCE EVENT** button.
6. Do the following substeps to set the AWG710B Arbitrary Waveform Generator marker output low level setting:
 - a. Push **Marker 1 Low Level** side button.
 - b. Push **-**, **2**, **.**, **0** and **ENTER** keys in this order or turn the general purpose knob to set the marker level to -2.0 V.
 - c. Verify that the marker 1 low level reading on the DMM screen falls within -2.2 V through -1.8 V.
 - d. Push the **FORCE EVENT** button.
7. Do the following substeps to change the connection to check the MARKER1:
 - a. Disconnect the 50 Ω precision terminator from the MARKER1 OUT connector.
 - b. Disconnect the cable (with SMA(Ma)-BNC(Fe) adapter and BNC 50 Ω terminator) from MARKER 1 OUT connector.
 - c. Connect the 50 Ω precision terminator to the MARKER 1 OUT (removed in step a).
 - d. Connect the adapter, terminator, and the cable (removed in step b) to the MARKER1 OUT connector.
8. Press Force Event where needed.

9. Repeat steps 5 and 6 for the AWG710B Arbitrary Waveform Generator MARKER1 OUT.
10. Repeat steps 5 through 8 for MARKER 2 OUT and MARKER2 OUT.
11. Disconnect the DMM.

Synchronous Operation Tests

These procedures check the signal path for the Synchronous Operation of the AWG710B Arbitrary Waveform Generator.

Equipment required	Four 50 Ω SMA C coaxial cables (P/N: 174-1427-00).
Prerequisites	The AWG710B Arbitrary Waveform Generator must meet the prerequisites listed on page B-7.

Do the following steps to install the test hookup and set the test equipment controls:

1. Use four 50 Ω SMA coaxial cables to connect the T IN connector to the T OUT1 connector, the T IN connector to the T OUT1 connector, the C IN connector to the C OUT1 connector, and the C IN connector to the C OUT1 connector(see Figure B-34).

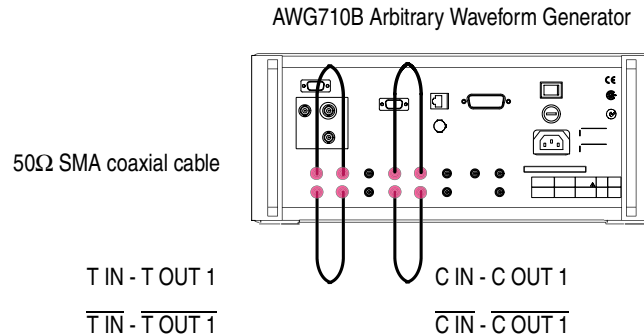

Figure B-34: Synchronous operation test hookup

2. Follow the substeps below to set the AWG710B Arbitrary Waveform Generator controls and to select the sequence file:
 - a. Push **UTILITY** (front-panel)→**System** (bottom)→**Factory Reset** (side)→**OK** (side).

- b. Push **SETUP** (front-panel)→**Extended Operation** (bottom)→**Sync - Master** (side).
 - c. Push **Connect** (bottom)→**Execute Trig Timing Calibration** (side).
 3. Check that **Pass** is displayed being displayed on the **Trigger Timing Cal.** field at the lower left of the AWG710B screen.
 4. Change the cable connection.
 - a. Disconnect the cable from the T OUT1 connector and connect it to the T OUT2 connector.
 - b. Disconnect the cable from the $\overline{\text{T OUT1}}$ connector and connect it to the $\overline{\text{T OUT2}}$ connector.
 - c. Disconnect the cable from the C OUT1 connector and connect it to the T OUT2 connector.
 - d. Disconnect the cable from the $\overline{\text{C OUT1}}$ connector and connect it to the $\overline{\text{T OUT2}}$ connector.
 5. Push **Execute Trig Timing Calibration** (side).
 6. Check that **Pass** is displayed being displayed on the **Trigger Timing Cal.** field at the lower left of the AWG710B screen.
 7. Disconnect the four SMA cables.

Appendix B: Performance Verification (AWG710)

Two types of Performance Verification procedures can be performed on this product: *Self Tests* and *Performance Tests*. You may not need to perform all of these procedures, depending on what you want to accomplish.

- Verify that the AWG710 Arbitrary Waveform Generator is operating correctly by running the self tests which begin on page B-56.

Advantages: These procedures require minimal time to perform, require no additional equipment, and test the internal hardware of the AWG710 Arbitrary Waveform Generator.

- If a more extensive confirmation of performance is desired, complete the self test, and then do the performance test beginning on page B-60.

Advantages: These procedures add direct checking of warranted specifications. They require more time to perform and suitable test equipment is required. (Refer to *Equipment Required* on page B-61).

Conventions

Throughout these procedures the following conventions apply:

- Each test procedure uses the following general format:

Title of Test

Equipment Required

Prerequisites

Procedure

- Each procedure consists of as many steps, substeps, and subparts as required to do the test. Steps, substeps, and subparts are sequenced as follows:

1. First Step

- a. First Substep

- First Subpart

- Second Subpart

- b. Second Substep

2. Second Step

- Instructions for menu selection use the following format: **front-panel BUTTON**→**Main Menu Button**→**Side Menu Button**. For example, Push **UTILITY**→**System**→**Reset to Factory**→**OK**
- The name of the button or knob appears in boldface type:
Push **EDIT**; then **Drive...**, push **Floppy** side button and use the knob to select **SINE.WFM** from the file list.

Self Tests

The *Self Tests* use internal routines to confirm basic functionality and proper adjustment. No test equipment is required to do these test procedures.

The self tests include internal diagnostics to verify that the instrument passes the internal circuit tests, and calibration routines to check and adjust the instrument internal calibration constants.

Diagnostics

This procedure uses internal routines to verify that the instrument is operating correctly. No test equipment or hookups are required.

The instrument automatically performs the internal diagnostics when powered on; you can also run the internal diagnostics using the menu selections described in this procedure. The difference between these two methods of initiating the diagnostics is that the menu method does a more detailed memory check than the power-on method.

Equipment required	None
Prerequisites	Power on the instrument and allow a twenty-minute warmup period before doing this procedure.

Confirm that there is no output being performed by verifying that the RUN LED is not on. If the LED is on, push the **RUN** button to turn it off.

Do the following to verify that the instrument passes the internal circuit tests:

Push **UTILITY** (front-panel)→**Diag** (bottom)→**Diagnostic All** (side).

The diagnostic menu is displayed and all tests are selected. Refer to Figure B-35. If All is not displayed, select All using the general purpose knob.

The list on the screen shows the test items and results in the calibration and diagnostics previously made. Select all of the test items shown on the screen or use the general purpose knob to select a single test item that you want to run.

The result of the diagnostics are shown as error code. Pass means that the tests have been made without error. If an error is detected, an error code is displayed.

You can also specify how many times the diagnostic tests are performed. Push the **Cycle** side button and then turn the general purpose knob to select the cycle from 1, 3, 10, 100 or Infinite. When you select Infinite, the tests are repeatedly performed, and are not be terminated until you push the **Abort Diagnostic** side button.

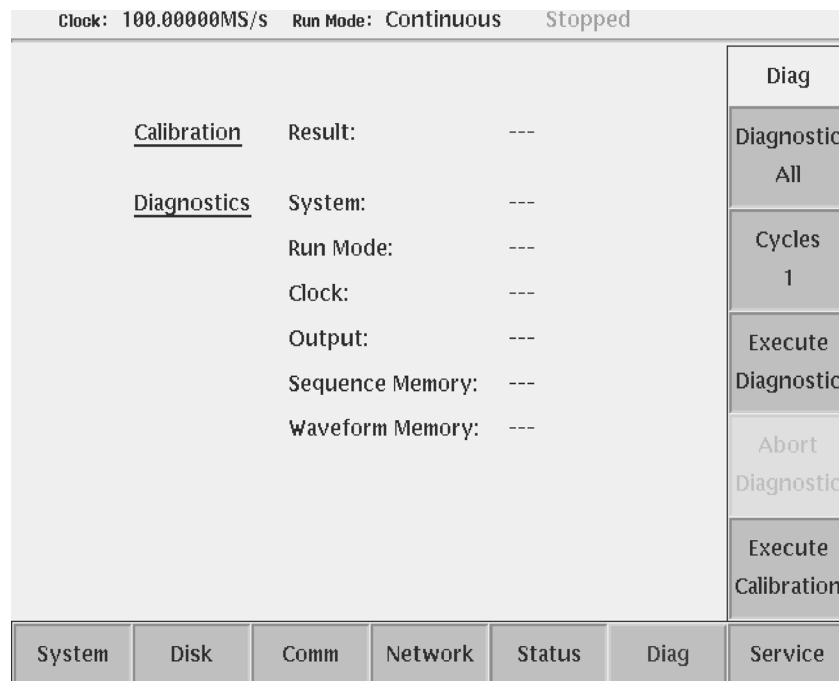

Figure B-35: Diagnostic menu

Do the following to execute all of the AWG710 Arbitrary Waveform Generator diagnostics automatically:

Push the **Execute Diagnostic** side button.

The internal diagnostics do an extensive verification of AWG710 Arbitrary Waveform Generator functions. While this verification progresses, the screen displays the clock icon. When finished, the resulting status appears on the screen.

Verify that no failures are found and reported on–screen. If the diagnostics terminates without error, Pass is displayed instead of the – – –. If a value is displayed, meaning an error is detected, consult a qualified service technician for further assistance.

Push any bottom or menu button (other than **UTILITY**) to exit the diagnostic screen.

Calibration The instrument includes internal calibration routines that check electrical characteristics such as offset, attenuations and filters. Perform calibration to adjust internal calibration constants as necessary. This procedure describes how to do the internal calibration.

Equipment required	None
Prerequisites	Power on the instrument and allow a 20 minute warmup period at an ambient temperature between +20° C and +30° C before doing this procedure.

Confirm that there is no output being performed by verifying that the **RUN LED** is not on. If the LED is on, push the **RUN** button to turn it off.

NOTE. *Some calibration items may fail if you start calibration while output is being performed.*

Do the following steps to verify that the internal adjustments have passed:

1. Push **UTILITY** (front-panel)→**Diag** (bottom)→**Execute Calibration** (side).

This executes the AWG710 Arbitrary Waveform Generator calibration routines automatically.

The internal calibration does an extensive verification of proper AWG710 Arbitrary Waveform Generator functions. While this verification progresses, the message box displaying *Executing Calibration* appear on screen. When finished, the resulting status will appear in the message box as shown in Figure B-36.

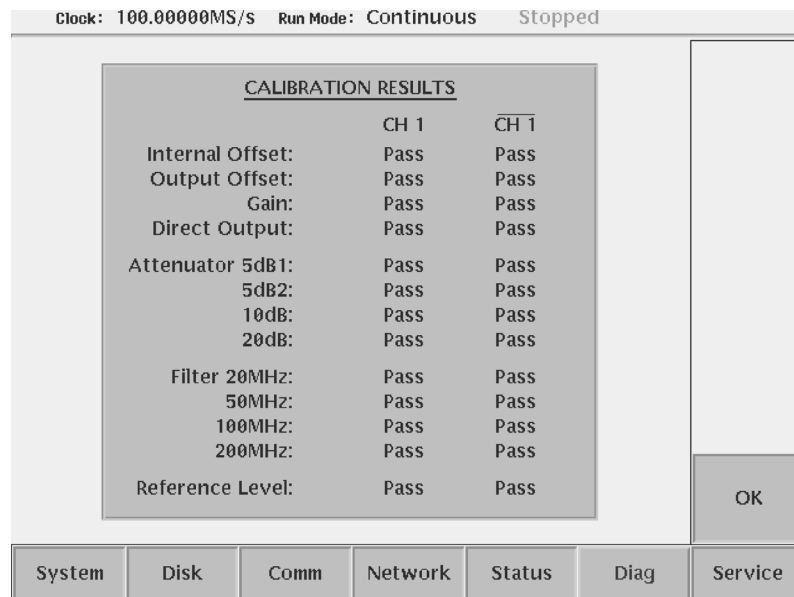

Figure B-36: Calibration result message box (except option 02)

Verify that no failures are found and reported in the message box. If the calibration displays Fail as the result, consult a qualified service technician for further assistance.

2. Push the **OK** side button and then any bottom or menu button (other than the **UTILITY**) to exit the dialog screen.

NOTE. *The calibration data in the memory may be lost if the instrument is powered off while the calibration is executed,*

Performance Tests

This section contains a collection of procedures for checking that the AWG710 Arbitrary Waveform Generator performs as warranted.

The procedures are arranged in eight logical groupings, presented in the following order:

Table B-4: Performance test items

Titles	See (performance verification)	Test items	See (specifications)
Operating mode tests	Page B-66	Continuous, Triggered, and Gated mode normality	Page A-28
Amplitude and offset accuracy tests (normal out)	Page B-72	Amplitude accuracy, and DC offset accuracy	Page A-29
Amplitude, DC offset and rise time accuracy tests (direct DA out)	Page B-77	Amplitude accuracy, DC offset accuracy and Rise time accuracy	Page A-30
Amplitude, DC offset and Rise time accuracy test (Option2)	Page B-81	Amplitude accuracy, DC offset accuracy and Rise time accuracy	Page A-30
Pulse response tests (normal out)	Page B-85	Rise time accuracy	Page A-30
Trigger input tests	Page B-87	Trigger level accuracy, and Trigger function normality	Page A-33
Event input and enhanced mode tests	Page B-91	External event input function normality, and Event mode normality	Page A-35
1/4 Clock frequency and 10 MHz reference input tests	Page B-98	1/4 clock output frequency and Reference input normality accuracy	Page A-31
Marker output tests	Page B-100	Marker output level accuracy	Page A-31

The performance tests check all of the characteristics that are designated as checked in *Appendix A: Specifications*. (The characteristic items that must be checked are listed with the check mark (✓) in *Appendix A: Specifications*).

NOTE. *These procedures extend the confidence level provided by the basic procedures described on page B-56. The basic procedures should be done first, and then these procedures performed if desired.*

Prerequisites The tests in this section comprise an extensive, valid confirmation of performance and functionality when the following requirements are met:

- The cabinet must be installed on the instrument.
- You must have performed and passed the procedures under *Self Tests*, found on page B-56.
- The waveform generator must have been recently adjusted at an ambient temperature between +20° C and +30° C, must have been operating for a warm-up period of at least 20 minutes, and must be operating at an ambient temperature between +10° C and +40° C.

Refer to *Conventions* on page B-55 for more information.

Equipment Required These procedures use external, traceable signal sources to directly check warranted characteristics. Table B-5 lists the required equipment used to complete the performance tests.

Table B-5: Test equipment

Item number and description	Minimum requirements	Example (recommended)	Purpose
1. Frequency Counter	1 MHz to 100 MHz, Accuracy: < 0.2 ppm	Anritsu MF1603A	Checks reference input.
2. Digital multi meter	DC volts range: 0.05 V to 10 V, Accuracy: $\pm 0.1\%$	Fluke 8842A	Measures voltage. Used in multiple procedures.
3. Oscilloscope	Bandwidth: > 500 MHz, 1 M Ω and 50 Ω inputs	Tektronix TDS784D	Checks output signals. Used in multiple procedures.
4. Oscilloscope	Bandwidth: > 6 GHz, Rise time: < 58.3 ps, 50 Ω input	Tektronix TDS820	Checks pulse response.
5. Function Generator	Output voltage: -5 V to +5 V, Frequency accuracy: < 0.01 %	Tektronix AFG310	Generates external input signals. Used in multiple input signal test procedures.
6. SMA Coaxial Cable (2 required)	50 Ω , male to male SMA connectors	Tektronix part number 174-1427-00	Signal interconnection
7. BNC Coaxial Cable (3 required)	50 Ω , male to male BNC connectors	Tektronix part number 012-0482-00	Signal interconnection
8. Adapter (2 required)	SMA (male) to BNC (female), 50 Ω	Tektronix part number 015-0554-00	Signal interconnection
9. Adapter	SMA (female) to BNC (male), 50 Ω	Tektronix part number 015-0572-00	Signal interconnection
10. BNC-T Connector	BNC (male) to BNC (female) to BNC (female)	Tektronix part number 103-0030-00	Signal interconnection
11. Dual-Banana Connector	BNC (female) to dual banana	Tektronix part number 103-0090-00	Signal interconnection

Table B-5: Test equipment (cont.)

Item number and description	Minimum requirements	Example (recommended)	Purpose
12. SMA Terminator (2 required)	50 Ω, SMA (male)	Tektronix part number 015-1022-01	Signal termination
13. Precision Terminator	50 Ω, 0.1 %, BNC	Tektronix part number 011-0129-00	Signal termination
14. Performance check disks	Must use example listed	Supplied with the product, Tektronix part number 062-A273-00	Used to provide waveform files.
15. Ground closure (loopback cable) with 9-pin, D-type connector		Custom, See Figure B-37.	Used for event mode test.

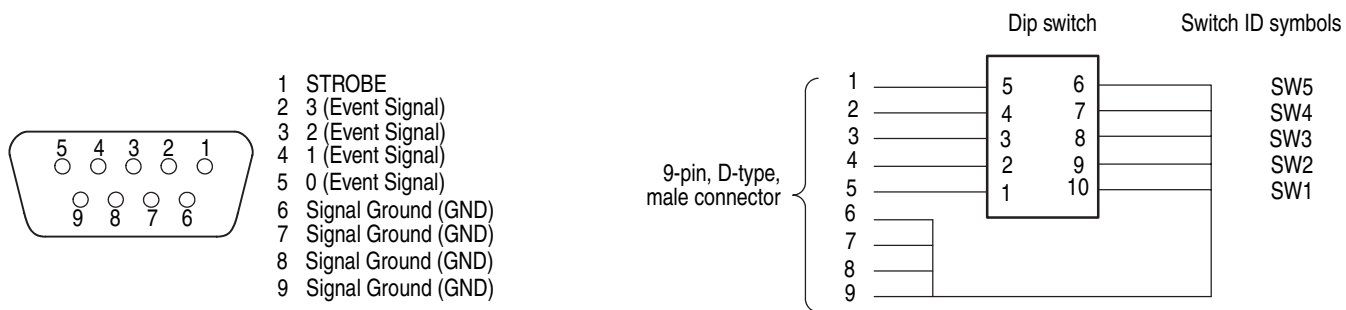

Figure B-37: EVENT IN connector pins and signals and ground closure connector

Loading Files

The following steps explain how to load files from the Performance Check/Adjustment disk into waveform memory and/or sequence memory.

1. Insert the disk into the AWG710 Arbitrary Waveform Generator floppy disk drive.
2. Select **SETUP** (front)→**Waveform/Sequence** (bottom)→**Load...** (side)→**Drive...** (side).

The Select Drive dialog box appears as show in Figure B-38.

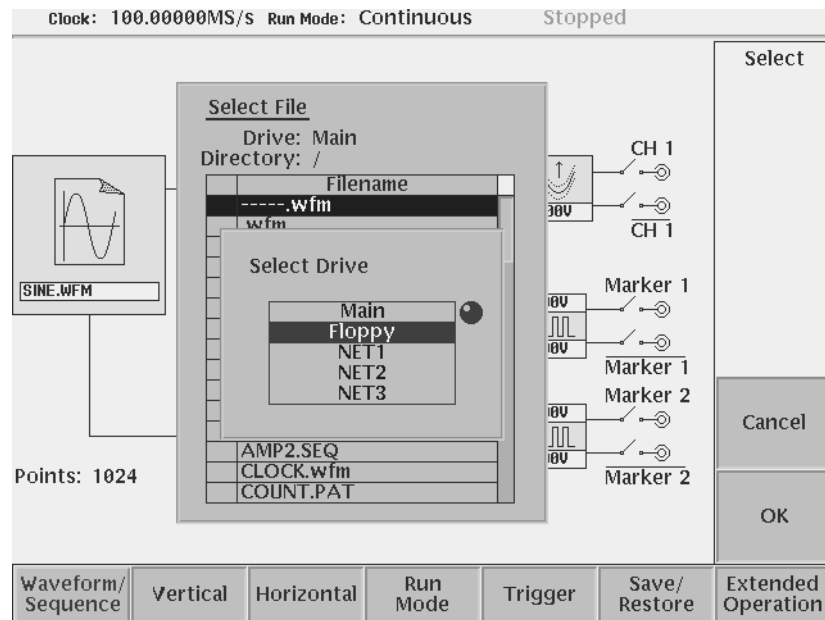

Figure B-38: Loading file; selecting storage drive

3. Select **Floppy** from the dialog box with the general purpose knob, and then push the **OK** side button.
The Select Drive dialog box disappears, and the files in the floppy disk are listed on the Select File dialog box.
4. Use the general purpose knob to select a file to be loaded from the dialog box, and then push the **OK** side button.
The waveform or sequence you selected is loaded into the instrument, and the instrument is also setup with the parameters stored in that file.
5. Remove the floppy disk from the floppy drive if the floppy disk is no longer needed.
6. Push any bottom button or menu button to exit the menu.

NOTE. The floppy disk file list displayed on the screen does not automatically update when you replace the diskette with another diskette. To update the file list, reselect the floppy disk drive.

Performance Check/Adjustment Files

Table B-6 lists the sequence and waveform files on the Performance Check/Adjustment disk that are used in these performance tests, the AWG710 Arbitrary Waveform Generator front-panel settings that each file sets up, and the performance test that uses each file.

NOTE. The files on the Performance Check disk are locked (the files are marked by the icon  in the file list), so the data in these files cannot be changed unless the lock is opened.

Table B-6: Waveforms and sequences in performance check disk











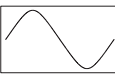

No.	File name	EDIT menu		SETUP menu				Marker setup	Usage
		Form	Points	Clock	Filter	Ampl	Offset		
1	MODE.WFM		1000	4 GHz	Through	1 V	0 V	Marker 1,2: 0 to 499: High, 500 to 999: Low	Run mode, Trigger level, Internal trigger accuracy
2	PULSE.WFM		1000	100 MHz	Through	1 V	0 V		Pulse response
3	AMP1.SEQ								Amplitude accuracy (Normal out), Marker
4	AMP2.SEQ								Amplitude accuracy (Direct out)
5	DC_PWFM (AMPx.SEQ) ¹		1000	100 MHz	Through	1 V	0 V		Amplitude accuracy
6	DC_M.WFM (AMPx.SEQ) ¹		1000	100 MHz	Through	1 V	0 V		Amplitude accuracy
7	DC0.WFM (AMP2.SEQ)		1000	100 MHz	Through	1 V	0 V		Amplitude accuracy
8	OFFSET.WFM		1000	100 MHz	Through	20 mV	0 V		Offset accuracy
9	TRIG.WFM		1000	1 MHz	Through	1 V	0 V		Trigger input
10	PT_EVENT.SEQ								Event input
11	PT_STROB.SEQ								Event input

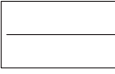
Table B-6: Waveforms and sequences in performance check disk (cont.)

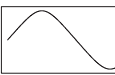
No.	File name	EDIT menu		SETUP menu				Marker setup	Usage
		Form	Points	Clock	Filter	Ampl	Offset		
12	S1024.WFM (PT_XXXXX.SEQ) ²		1024	400 MHz	Through	1 V	0 V		Event input
13	S1024H.WFM (PT_XXXXX.SEQ) ²		1024	400 MHz	Through	1 V	0 V		Event input
14	R1024H.WFM (PT_XXXXX.SEQ) ²		1024	400 MHz	Through	1 V	0 V		Event input
15	T1024H.WFM (PT_XXXXX.SEQ) ²		1024	400 MHz	Through	1 V	0 V		Event input
16	Q1024H.WFM (PT_XXXXX.SEQ) ²		1024	400 MHz	Through	1 V	0 V		Event input
17	NULL1024H.WFM (PT_XXXXX.SEQ) ²		1024	400 MHz	Through	1 V	0 V		Event input

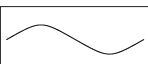
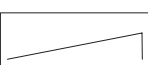
¹ The AMPx.SEQ represents AMP1.SEQ and AMP2.SEQ.

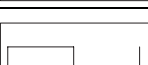
² The PT_XXXXX.SEQ represents PT_EVENT.SEQ and PT_STROB.SEQ

Operating Mode Tests

The following procedures verify the operation of the Cont, Triggered and Gated modes.

NOTE. When you output signal from the CH1 or $\overline{CH1}$ OUTPUT, check that the other OUTPUT ($\overline{CH1}$ or CH1) LED is off.
If the other OUTPUT LED is on, push the $\overline{CH1}$ or CH1 OUT button to turn off the output.

Check Cont Mode

Equipment required	A 50 Ω SMA coaxial cable, a SMA(Female)-BNC(Ma) adapter and an oscilloscope (TDS700).
Prerequisites	The AWG710 Arbitrary Waveform Generator must meet the prerequisites listed on page B-61.

Do the following steps to install the test hookup and set the test equipment controls:

1. Use a 50 Ω SMA coaxial cable to connect the AWG710 Arbitrary Waveform Generator CH1 output connector to the oscilloscope CH1 input connector (see Figure B-39).

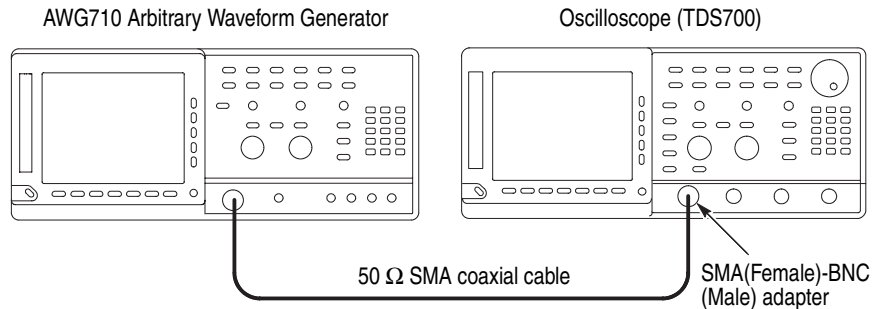

Figure B-39: Cont mode initial test hookup

2. Set the oscilloscope controls as follows:

Vertical	CH1
CH1 coupling.....	DC
CH1 scale	200 mV/div
CH1 input impedance	50 Ω
Horizontal	
Sweep	100 ns/div

Trigger	
Source.....	CH1
Coupling.....	DC
Slope.....	Positive
Level.....	+100 mV
Mode.....	Auto

Do the following steps to set the AWG710 Arbitrary Waveform Generator controls and to select the waveform file:

1. Push **UTILITY** (front-panel)→**System** (bottom)→**Factory Reset** (side)→**OK** (side).
2. Load the MODE.WFM file.
Refer to *Loading Files* on page B-62 for file loading procedures.
3. Push the **RUN** and **CH1** output buttons.
The LEDs above the RUN button and CH1 output connectors are on.
4. Check that the amplitude of the sine wave displayed on the oscilloscope is 5 vertical divisions and that a waveform of approximately one cycle per 2.5 horizontal divisions is displayed.

Check Triggered Mode

The following table lists the equipment and prerequisites required to check the Triggered mode.

Equipment required	Two 50 Ω BNC coaxial cables, a 50 Ω SMA coaxial cable, a SMA(Fe)–BNC(Ma) adapter, a BNC–T (male to 2 females) adapter, a function generator, and an oscilloscope (TDS700).
Prerequisites	The AWG710 Arbitrary Waveform Generator must meet the prerequisites listed on page B-61.

Do the following steps to install the test hookup and set the test equipment controls:

1. Use a 50 Ω BNC coaxial cable and a BNC–T adapter to connect the function generator output connector to the AWG710 Arbitrary Waveform Generator TRIG IN connector. Refer to Figure B-40.
2. Connect a second 50 Ω BNC coaxial cable to the BNC–T adapter. Connect the opposite end of the coaxial cable to the oscilloscope CH2 input.
3. Use a 50 Ω SMA coaxial cable and SMA(Fe)–BNC(Ma) adapter to connect the AWG710 Arbitrary Waveform Generator CH1 output connector to the oscilloscope CH1 input connector.

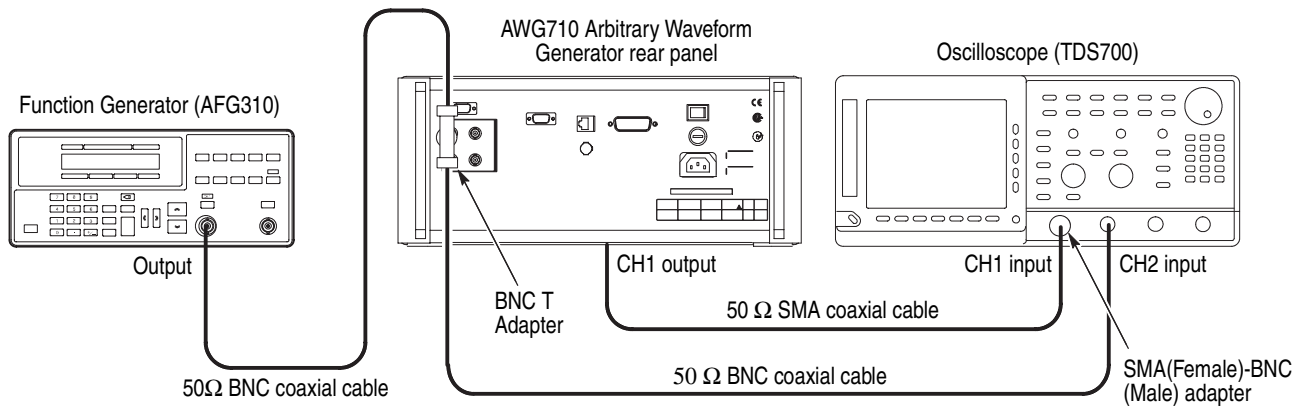

Figure B-40: Triggered mode initial test hookup

4. Set the oscilloscope controls as follows:

Vertical	
CH1 and CH2	
CH1 and CH2 coupling	DC
CH1 scale	500 mV/div
CH2 scale	2 V/div
CH1 input impedance	50 Ω
CH2 input impedance	1 MΩ
Horizontal	
Sweep	200 ns/div
Trigger	
Source	CH1
Coupling	DC
Slope	Positive
Level	+100 mV
Mode	NORMAL

5. Set the function generator (AFG310) controls as follows:

Function	Square
Mode	Continuous
Parameters	
Frequency	1 MHz
Amplitude	2.0 V into 50 Ω (4.0 V into 1 MΩ)
Offset	1.0 V into 50 Ω (2.0 V into 1 MΩ)
Output	Off

6. Follow the substeps below to set the AWG710 Arbitrary Waveform Generator controls and to select the waveform file:
 - a. Push **UTILITY** (front-panel)→**System** (bottom)→**Factory Reset** (side)→**OK** (side).
 - b. Push **SETUP** (front-panel)→**Run Mode** (bottom)→**Triggered** (side)
 - c. Load the MODE.WFM file.

Refer to *Loading Files* on page B-62 for file loading procedures.

- d. Push the **RUN** and **CH1** output buttons.

The LEDs above the RUN button and CH1 output connectors are on.

- e. Push the **FORCE TRIGGER** button.

Verify that the oscilloscope displays a one-cycle sine wave when the FORCE TRIGGER button is pushed. You may need to adjust the horizontal position control to see the signal.

7. Follow the substeps below to check the triggered mode with external triggering:

- a. Turn on the function generator output.
- b. Verify that the oscilloscope displays a one-cycle sine wave for each trigger supplied by the function generator. See Figure B-41.

Retain the test hookup.

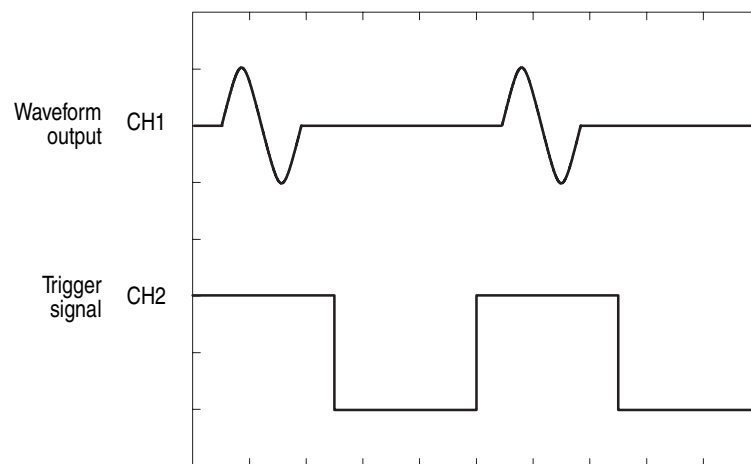

Figure B-41: Relationship between trigger signal and waveform output

Check Gated Mode

Equipment required	Two 50 Ω BNC coaxial cables, a 50 Ω SMA coaxial cable, a SMA(Fe)–BNC(Ma) adapter, a BNC–T (male to 2 females) adapter, a function generator, and an oscilloscope (TDS700).
Prerequisites	The AWG710 Arbitrary Waveform Generator must meet the prerequisites listed on page B-61.

1. Set the oscilloscope controls as follows:

Vertical	CH1 and CH2
CH1 and CH2 coupling	DC
CH1 scale	500 mV/div
CH2 scale	2 V/div
CH1 input impedance	50 Ω
CH2 input impedance	1 M Ω
Horizontal	
Sweep	20 μ s/div
Trigger	
Source	CH1
Coupling	DC
Slope	Positive
Level	100 mV
Mode	NORMAL

2. Set the function generator (AFG310) controls as follows:

Function	Square
Mode	Continuous
Parameters	
Frequency	10.1 kHz
Amplitude	2.0 V into 50 Ω (4.0 V into 1 M Ω)
Offset	1.0 V into 50 Ω (2.0 V into 1 M Ω)
Output	Off

3. Follow the substeps below to set the AWG710 Arbitrary Waveform Generator controls and to select the waveform file:

- a.** Push **UTILITY** (front–panel)→**System** (bottom)→**Factory Reset** (side)→**OK** (side).
- b.** Push **SETUP** (front–panel)→**Run Mode** (bottom)→**Gated** (side).
- c.** Load the MODE.WFM file.
Refer to *Loading Files* on page B-62 for file loading procedures.
- d.** Push **HORIZONTAL MENU** (front–panel)→ **Clock** (side).

e. Push **1, 0, 0** and **M** (SHIFT+7) keys in this order or turn the general purpose knob to set the internal clock frequency to 100 MHz.

f. Push the **RUN** and **CH1** output buttons.

The LEDs above the **RUN** button and **CH1** output connector are on.

g. Push the **FORCE TRIGGER** button.

Verify that the oscilloscope displays sine waves while the **FORCE TRIGGER** button is pushed and that the output stops when the Force Trigger button is released.

4. Follow the substeps below to check the gated mode with the gate signal:
 - a. Set the oscilloscope trigger source to CH2 and change the trigger level to 1 V.
 - b. Turn on the function generator output.
 - c. Verify that the oscilloscope displays sine waves while the function generator gate signal amplitude is High level. See Figure B-42.

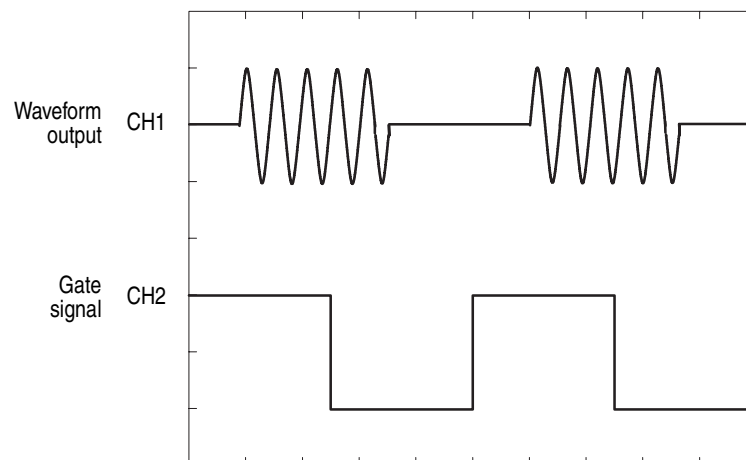

Figure B-42: Relationship between gate signal and waveform output

d. Push **SETUP** (front-panel)→**Trigger** (bottom)→**Negative** (side).

This changes the AWG710 Arbitrary Waveform Generator trigger polarity to negative.

5. Verify that the oscilloscope displays sine waves while the function generator gate signal amplitude is Low level.
6. Turn off the function generator output and disconnect from the oscilloscope.

Amplitude and Offset Accuracy Tests (Normal Out), (except option 02)

These procedures check the accuracy of the amplitude and offset outputs of the AWG710 Arbitrary Waveform Generator.

NOTE. *The amplitude and offset accuracy checks are structured as a continuous test. The next test uses the control settings from the previous test and uses the next step in the sequence file.*

NOTE. *When you output signal from the $\overline{CH1}$ or CH1 OUTPUT, check that the other OUTPUT ($\overline{CH1}$ or CH1) LED is off. If the other OUTPUT LED is on, push the $\overline{CH1}$ or CH1 OUT button to turn off the output.*

Check Amplitude Accuracy

Equipment required	A 50 Ω BNC coaxial cable, a 50 Ω precision terminator, a SMA(Ma)–BNC(Fe) adapters, BNC (female)–to–dual banana adapter, and a digital multimeter (DMM).
Prerequisites	The AWG710 Arbitrary Waveform Generator must meet the prerequisites listed on page B-61.

Do the following steps to install the test hookup and set the test equipment controls:

1. Use a 50 Ω BNC coaxial cable, a SMA(Ma)–BNC(Fe) adapter, a 50 Ω precision terminator, and a BNC–to–dual banana adapter to connect the AWG710 Arbitrary Waveform Generator CH1 output to the DMM input connector (see Figure B-43).

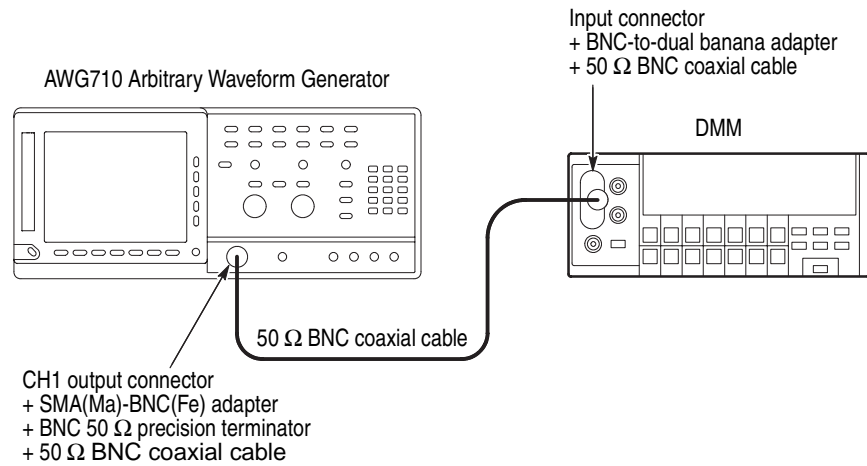

Figure B-43: Amplitude accuracy initial test hookup

2. Set the DMM controls as follows:

Mode	VDC
Range	Auto
Input	Front

3. Follow the substeps below to set the AWG710 Arbitrary Waveform Generator controls and to select the sequence file:

- a. Push **UTILITY** (front-panel)→**System** (bottom)→**Factory Reset** (side)→**OK** (side).
- b. Push **SETUP** (front-panel)→**Run Mode** (bottom)→**Enhanced** (side).

The AWG710 Arbitrary Waveform Generator is set to enhanced mode.

- c. Load the AMP1.SEQ file.

Refer to *Loading Files* on page B-62 for file loading procedures.

4. Push the **RUN** and **CH1** output buttons.

The LEDs above the RUN button and CH1 output connector are on.

5. Do the following substeps to set the AWG710 Arbitrary Waveform Generator amplitude and confirm the offset setting:
 - a. Push **VERTICAL MENU** (front-panel)→**Amplitude** (side).
 - b. Push **0**, **.**, **0**, **2** and **ENTER** keys in this order or turn the general purpose knob to set the amplitude to 0.020 V.
 - c. Verify that the offset setting display on the Offset side button is 0.000 V.
If the offset display is not set correctly, push the **Offset** side button, and push **0** and then **ENTER** key.
6. Do the following substeps to check the amplitude accuracy of a 20 mV amplitude setting:
 - a. Write the DMM reading as a positive voltage.
 - b. Push the **FORCE EVENT** button.
 - c. Write the DMM reading as a negative voltage.
 - d. Verify that the positive minus negative voltages fall within $20\text{ mV} \pm 2.4\text{ mV}$.
 - e. Push **0**, **.**, **2** and **ENTER** keys in this order or turn the general purpose knob to set the amplitude to 0.200 V.
7. Do the following to check the amplitude accuracy of 200 mV amplitude setting:
 - a. Push the **FORCE EVENT** button.
 - b. Write the DMM reading as a positive voltage.
 - c. Push the **FORCE EVENT** button.
 - d. Write the DMM reading as a negative voltage.
 - e. Verify that the positive minus negative voltages fall within $200\text{ mV} \pm 6\text{ mV}$.
 - f. Push the **2** and the **ENTER** keys in this order or turn the general purpose knob to set the amplitude to 2 V.
8. Do the following substeps to check the amplitude accuracy of 2 V amplitude setting:
 - a. Push the **FORCE EVENT** button.
 - b. Write the DMM reading as a positive voltage.
 - c. Push the **FORCE EVENT** button.

- d. Write the DMM reading as a negative voltage.
 - e. Check that the positive minus negative voltages fall within $2\text{ V} \pm 0.042\text{ V}$.
9. Do the following substeps to change the connection to check the $\overline{\text{CH1}}$:
 - a. Push the **CH1** output button.
 - b. Disconnect the adapter, terminator and cable from the **CH1** output connector.
 - c. Connect the adapter, terminator, and the cable (removed in step b) to the $\overline{\text{CH1}}$ output connector.
 - d. Push the $\overline{\text{CH1}}$ output button to turn on the $\overline{\text{CH1}}$ LED.
 10. Repeat the *Check Amplitude Accuracy* procedure for the AWG710 Arbitrary Waveform Generator $\overline{\text{CH1}}$ beginning on page B-72.
 11. Reconnect the test hookup on the $\overline{\text{CH1}}$ output to the CH1 output. Retain the control settings.

Check Offset Accuracy

The following procedure checks the Offset Accuracy.

1. Use the test hookup and settings from previous check on page B-72 and B-73.
2. Follow the substeps below to set the AWG710 Arbitrary Waveform Generator controls and to select the sequence file:
 - a. Push **UTILITY** (front-panel)→**System** (bottom)→**Factory Reset** (side)→**OK** (side).
 - b. Load the OFFSET.WFM file.
Refer to *Loading Files* on page B-62 for file loading procedures.
 - c. Push **VERTICAL MENU** (front-panel)→**Amplitude** (side).
 - d. Push **0**, **.**, **0**, **2** and **ENTER** keys in this order or turn the general purpose knob to set the amplitude to 0.020 V.
3. Push the **RUN** and **CH1** output buttons.
The LEDs above the RUN button and CH1 output connector are on.

4. Do the following substeps to set the *AWG710 Arbitrary Waveform Generator* offset:
 - a. Push the **Offset** side button.
 - b. Push **0** and **ENTER** keys in this order.
 - c. Verify that the reading on the DMM falls within $0\text{ V} \pm 10\text{ mV}$.
 - d. Push **0**, **.**, **5** and **ENTER** keys in this order to change the AWG710 Arbitrary Waveform Generator offset to 0.5 V .
 - e. Verify that the reading on the DMM falls within $0.5\text{ V} \pm 0.0175\text{ V}$.
 - f. Push **-**, **0**, **.**, **5** and **ENTER** keys in this order to change the AWG710 Arbitrary Waveform Generator offset to -0.5 V .
 - g. Check that the reading on the DMM falls within $-0.5\text{ V} \pm 0.0175\text{ V}$.
5. Do the following substeps to change the connection to check the $\overline{\text{CH1}}$:
 - a. Push the **CH1** output button.
 - b. Disconnect the adapter, terminator and cable from the **CH1** output connector.
 - c. Connect the adapter, terminator, and cable (removed in step b) to the $\overline{\text{CH1}}$ output connector.
 - d. Push the $\overline{\text{CH1}}$ output button to turn on the $\overline{\text{CH1}}$ LED.
6. Repeat the *Check Offset Accuracy* procedure for the AWG710 Arbitrary Waveform Generator $\overline{\text{CH1}}$.
7. Push the $\overline{\text{CH1}}$ output button to turn off the $\overline{\text{CH1}}$ LED.
8. Disconnect the test hookup from the $\overline{\text{CH1}}$ output connector.

Amplitude, Offset Accuracy and Rise Time Tests (Direct DA Out), (except option 02)

These procedures check the accuracy of the AWG710 Arbitrary Waveform Generator direct waveform outputs; amplitude and offset.

Check Amplitude and DC Offset

Equipment required	A 50 Ω BNC coaxial cable, a 50 Ω precision terminator, an SMA(Ma)–BNC(Fe) adapter, BNC (female)–to–dual banana adapter, and a digital multimeter (DMM).
Prerequisites	The AWG710 Arbitrary Waveform Generator must meet the prerequisites listed on page B-61.

Do the following steps to install the test hookup and set the test equipment controls:

1. Use a 50 Ω BNC coaxial cable, an SMA(Ma)–BNC(Fe) adapter, a 50 Ω precision terminator, and a BNC–to–dual banana adapter to connect the AWG710 Arbitrary Waveform Generator **CH1** output to the DMM input connector (see Figure B-44).

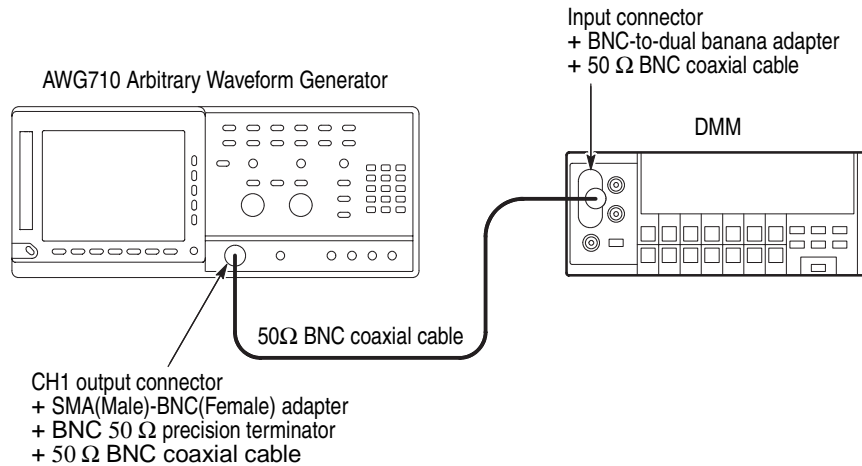

Figure B-44: Direct DA output amplitude accuracy initial test hookup

2. Set the DMM controls as follows:

Mode VDC
 Range 2 V
 Input Front

3. Push **UTILITY** (front–panel)→**System** (bottom)→**Factory Reset** (side)→**OK** (side).

4. Push **SETUP** (front-panel)→**Run Mode** (bottom)→**Enhanced** (side).
The AWG710 Arbitrary Waveform Generator is set to enhanced mode.
5. Push **VERTICAL MENU** (front-panel)→**Output** (side)→**Direct** (side).
6. Load the AMP2.SEQ file.
Refer to *Loading Files* on page B-62 for file loading procedures.
7. Push the **RUN** and **CH1** output buttons.
The LEDs above the RUN button and CH1 output connector are on.
8. Do the following substeps to check the direct DA amplitude accuracy of 1 V amplitude setting:
 - a. Write the DMM reading as a positive voltage.
 - b. Push the **FORCE EVENT** button.
 - c. Write the DMM reading as a negative voltage.
 - d. Verify that the positive minus negative voltages fall within $1.0\text{ V} \pm 0.022\text{ V}$.
 - e. Push **VERTICAL MENU** (front-panel)→**Amplitude** (side).
 - f. Push **0**, **,0**, **2** and **ENTER** keys in this order or turn the general purpose knob to set the amplitude to 0.020 V.
9. Do the following to check the direct DA amplitude accuracy of 20 mV amplitude setting:
 - a. Push the **FORCE EVENT** button twice.
 - b. Write the DMM reading as a positive voltage.
 - c. Push the **FORCE EVENT** button.
 - d. Write the DMM reading as a negative voltage.
 - e. Verify that the positive minus negative voltages fall within $20\text{ mV} \pm 2.4\text{ mV}$.
10. Follow the substeps below to check the DC offset:
 - a. Push the **FORCE EVENT** button.
 - b. Verify that the reading on the DMM falls within $0\text{ V} \pm 10\text{ mV}$.
11. Do the following substeps to change the connection to check the $\overline{\text{CH1}}$:
 - a. Push the **CH1** output button.
 - b. Disconnect the adapter, terminator and cable from the **CH1** output connector.
 - c. Connect the adapter, terminator, and cable (removed in step b) to the $\overline{\text{CH1}}$ output connector.

- d. Push the **CH1** output button to turn on the **CH1** LED.
- e. Push the **FORCE EVENT** button.
- 12. Repeat steps 8 through step 10 for the AWG710 Arbitrary Waveform Generator **CH1**.
- 13. Push the **CH1** output button to turn off the **CH1** LED.
- 14. Push the **RUN** button to turn off the RUN LED.
- 15. Disconnect the DMM.

Check Pulse Rise Time

Equipment required	A 50 Ω SMA coaxial cable and an oscilloscope (TDS820).
Prerequisites	The AWG710 Arbitrary Waveform Generator must meet the prerequisites listed on page B-61.

Do the following steps to install the test hookup and set the test equipment controls:

- 1. Use the 50 Ω SMA coaxial cable to connect the AWG710 Arbitrary Waveform Generator CH1 output connector to the oscilloscope CH1 input connector (see Figure B-45).

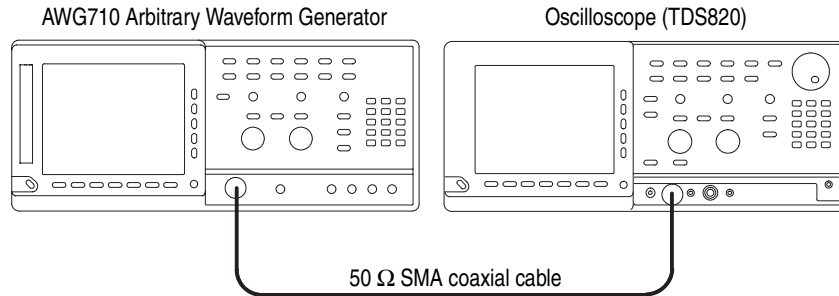



Figure B-45: Direct DA output pulse rise time initial test hookup

- 2. Set the oscilloscope controls as follows:

Vertical CH1
 CH1 coupling..... DC if applicable
 CH1 scale 100 mV/div
 Horizontal

Sweep 500 ps/div
 Trigger
 Source CH1
 Slope 
 Level 0 V
 Mode Auto

NOTE. The pulse rise time tests use the AWG710 Arbitrary Waveform Generators control settings that have been used in the amplitude and DC offset tests. Do not initialize the AWG710 Arbitrary Waveform Generator controls.

3. Load the PULSE.WFM file.
 Refer to *Loading Files* on page B-62 for file loading procedures.
4. Push **SETUP** (front-panel)→**Run Mode** (bottom)→**Continuous** (side).
 The AWG710 Arbitrary Waveform Generator is set to the Continuous mode.
5. Change the AWG710 Arbitrary Waveform Generator controls as follows:
 - a. Push **VERTICAL MENU** (bottom)→**Amplitude** (side).
 - b. Push **0**, **.**, **5** and **ENTER** keys in this order or turn the general purpose knob to set the amplitude to 0.5 V.
 - c. Verify that the Direct DA out is set. If not, push **Output** (side)→**Direct** (side).
6. Push the **RUN** and **CH1** output buttons.
 The LEDs above the RUN button and CH1 output connectors are on.
7. Verify that the rise time of the pulse waveform displayed on the oscilloscope is equal to or less than 280 ps.
8. Do the following substeps to change the connection to check the $\overline{\text{CH1}}$:
 - a. Push the **CH1** output button.
 - b. Disconnect the cable from the CH1 output connector.
 - c. Connect the cable to the $\overline{\text{CH1}}$ output connector.
 - d. Push the $\overline{\text{CH1}}$ output button to turn on the $\overline{\text{CH1}}$ LED.
9. Repeat step 7 to verify the rise time for the AWG710 Arbitrary Waveform Generator $\overline{\text{CH1}}$.
10. Push the $\overline{\text{CH1}}$ output button to turn off the $\overline{\text{CH1}}$ LED.

Amplitude, Offset Accuracy and Rise Time Tests (for option 02)

These procedures check the accuracy of the AWG710 Arbitrary Waveform Generator option02 outputs; amplitude and offset.

Check Amplitude and DC Offset

Equipment required	A 50 Ω BNC coaxial cable, a 50 Ω precision terminator, an SMA(Ma)-BNC(Fe) adapter, BNC (female)-to-dual banana adapter, and a digital multimeter (DMM).
Prerequisites	The AWG710 option 02 Arbitrary Waveform Generator must meet the prerequisites listed on page B-61.

Do the following steps to install the test hookup and set the test equipment controls:

1. Use a 50 Ω BNC coaxial cable, an SMA(Ma)-BNC(Fe) adapter, a 50 Ω precision terminator, and a BNC-to-dual banana adapter to connect the AWG710 Arbitrary Waveform Generator **CH1** output to the DMM input connector (see Figure B-46).

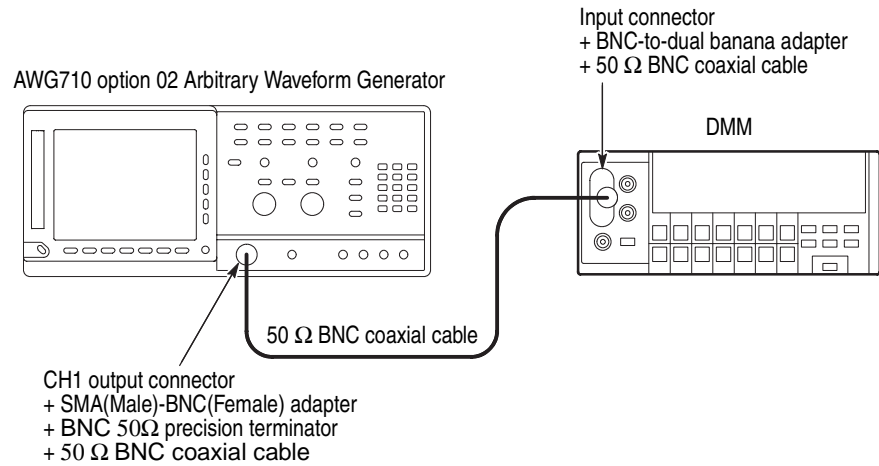

Figure B-46: Option02 output amplitude accuracy initial test hookup

2. Set the DMM controls as follows:

Mode VDC
 Range 2 V
 Input Front

3. Push **UTILITY** (front-panel)→**System** (bottom)→**Factory Reset** (side)→**OK** (side).

4. Push **SETUP** (front-panel)→**Run Mode** (bottom)→**Enhanced** (side).
The AWG710 Arbitrary Waveform Generator is set to enhanced mode.
5. Load the AMP2.SEQ file.
Refer to *Loading Files* on page B-62 for file loading procedures.
6. Push the **RUN** and **CH1** output buttons.
The LEDs above the RUN button and CH1 output connector are on.
7. Do the following substeps to check the option02 amplitude accuracy of 1 V amplitude setting:
 - a. Write the DMM reading as a positive voltage.
 - b. Push the **FORCE EVENT** button.
 - c. Write the DMM reading as a negative voltage.
 - d. Verify that the positive minus negative voltages fall within $1.0\text{ V} \pm 0.022\text{ V}$.
 - e. Push **VERTICAL MENU** (front-panel)→**Amplitude** (side).
 - f. Push **0**, **.**, **5** and **ENTER** keys in this order or turn the general purpose knob to set the amplitude to 0.500 V.
8. Do the following to check the option02 amplitude accuracy of 500 mV amplitude setting:
 - a. Push the **FORCE EVENT** button twice.
 - b. Write the DMM reading as a positive voltage.
 - c. Push the **FORCE EVENT** button.
 - d. Write the DMM reading as a negative voltage.
 - e. Verify that the positive minus negative voltages fall within $500\text{ mV} \pm 12\text{ mV}$.
9. Follow the substeps below to check the DC offset:
 - a. Push the **FORCE EVENT** button.
 - b. Verify that the reading on the DMM falls within $0\text{ V} \pm 10\text{ mV}$.
10. Do the following substeps to change the connection to check the $\overline{\text{CH1}}$:
 - a. Push the **CH1** output button.
 - b. Disconnect the adapter, terminator and cable from the **CH1** output connector.

- c. Connect the adapter, terminator, and cable (removed in step b) to the $\overline{\text{CH1}}$ output connector.
 - d. Push the $\overline{\text{CH1}}$ output button to turn on the $\overline{\text{CH1}}$ LED.
 - e. Push the **FORCE EVENT** button.
11. Repeat steps 7 through step 9 for the AWG710 Arbitrary Waveform Generator $\overline{\text{CH1}}$.
 12. Push the $\overline{\text{CH1}}$ output button to turn off the $\overline{\text{CH1}}$ LED.
 13. Push the **RUN** button to turn off the RUN LED.
 14. Disconnect the DMM.

Check Pulse Rise Time

Equipment required	A 50 Ω SMA coaxial cable and an oscilloscope (TDS820).
Prerequisites	The AWG710 Arbitrary Waveform Generator must meet the prerequisites listed on page B-61.

Do the following steps to install the test hookup and set the test equipment controls:

1. Use the 50 Ω SMA coaxial cable to connect the AWG710 Arbitrary Waveform Generator CH1 output connector to the oscilloscope CH1 input connector (see Figure B-47).

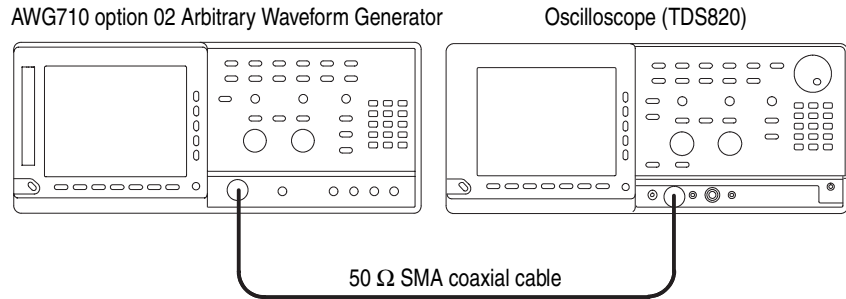



Figure B-47: Optipn02 output pulse rise time initial test hookup

2. Set the oscilloscope controls as follows:

Vertical CH1
 CH1 coupling..... DC if applicable
 CH1 scale 200 mV/div
 Horizontal
 Sweep 200 ps/div

Trigger

Source.....	CH1
Slope.....	
Level.....	0 V
Mode.....	Auto

NOTE. The pulse rise time tests use the AWG710 Arbitrary Waveform Generators control settings that have been used in the amplitude and DC offset tests. Do not initialize the AWG710 Arbitrary Waveform Generator controls.

3. Load the PULSE.WFM file.
Refer to *Loading Files* on page B-62 for file loading procedures.
4. Push **SETUP** (front-panel)→**Run Mode** (bottom)→**Continuous** (side).
The AWG710 Arbitrary Waveform Generator is set to the Continuous mode.
5. Change the AWG710 Arbitrary Waveform Generator controls as follows:
 - a. Push **VERTICAL MENU** (bottom)→**Amplitude** (side).
 - b. Push **1** and **ENTER** keys in this order or turn the general purpose knob to set the amplitude to 1 V.
6. Push the **RUN** and **CH1** output buttons.
The LEDs above the RUN button and CH1 output connectors are on.
7. Verify that the rise time of the pulse waveform displayed on the oscilloscope is equal to or less than 175 ps.
8. Do the following substeps to change the connection to check the $\overline{\text{CH1}}$:
 - a. Push the **CH1** output button.
 - b. Disconnect the cable from the CH1 output connector.
 - c. Connect the cable to the $\overline{\text{CH1}}$ output connector.
 - d. Push the $\overline{\text{CH1}}$ output button to turn on the $\overline{\text{CH1}}$ LED.
9. Repeat step 7 to verify the rise time for the AWG710 Arbitrary Waveform Generator $\overline{\text{CH1}}$.
10. Push the $\overline{\text{CH1}}$ output button to turn off the $\overline{\text{CH1}}$ LED.

Pulse Response Tests (Normal Out), (except option 02)

This procedure checks the pulse response characteristics of the AWG710 Arbitrary Waveform Generator output waveforms at amplitudes of 1 V.

Equipment required	A 50 Ω SMA coaxial cable and an oscilloscope (TDS820).
Prerequisites	The AWG710 Arbitrary Waveform Generator must meet the prerequisites listed on page B-61.

Do the following steps to install the test hookup and set the test equipment controls:

1. Use the 50 Ω SMA coaxial cable to connect the AWG710 Arbitrary Waveform Generator CH1 output connector to the oscilloscope CH1 input connector (see Figure B-48).

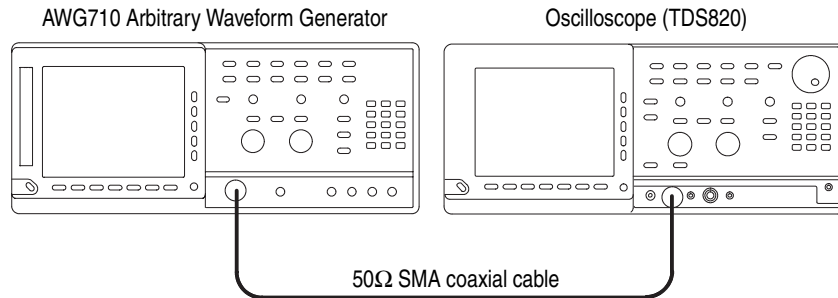

Figure B-48: Pulse response initial test hookup

2. Set the oscilloscope controls as follows:

VerticalCH1	
CH1 coupling.....	DC if applicable
CH1 scale	200 mV/div
Horizontal	
Sweep	500 ps/div
Trigger	
Source.....	CH1
Slope.....	Positive
Level	0 V
Mode.....	Auto

3. Push **UTILITY** (front-panel)→**System** (bottom)→**Factory Reset** (side)→**OK** (side).

4. Load the PULSE.WFM file.
Refer to *Loading Files* on page B-62 for file loading procedures.
5. Push the **RUN** and **CH1** output buttons.
The LEDs above the RUN button and CH1 output connector are on.
6. Verify the pulse response at 1 V amplitude.
 - a. Verify that the rise time of the waveform displayed on the oscilloscope from 10% to 90% point is equal to or less than 480 ps.
7. Do the following substeps to change the connection to check the $\overline{\text{CH1}}$:
 - a. Push the **CH1** output button.
 - b. Disconnect the cable from the CH1 output connector.
 - c. Connect the cable to the $\overline{\text{CH1}}$ output connector.
 - d. Push the $\overline{\text{CH1}}$ output button to turn on the $\overline{\text{CH1}}$ LED.
8. Repeat the *Check Pulse Response procedure* for the AWG710 Arbitrary Waveform Generator $\overline{\text{CH1}}$.
9. Push the $\overline{\text{CH1}}$ output button to turn off the $\overline{\text{CH1}}$ LED.
10. Disconnect the oscilloscope.

Trigger Input Tests

These procedures check the trigger level accuracy of the AWG710 Arbitrary Waveform Generator.

Equipment required	Two 50 Ω BNC coaxial cables, a 50 Ω SMA coaxial cable, a SMA(Female)–BNC(Male) adapter, a BNC–T (male to 2 females) adapter, a function generator, and an oscilloscope (TDS700).
Prerequisites	The AWG710 Arbitrary Waveform Generator must meet the prerequisites listed on page B-61.

Do the following steps to install the test hookup and set the test equipment controls:

1. Use a 50 Ω SMA coaxial cable and an SMA(Female)–BNC(Fe) adapter to connect the AWG710 Arbitrary Waveform Generator CH1 output connector to the oscilloscope CH1 input connector.
2. Use a BNC coaxial cable to connect the function generator to the BNC–T adapter which goes to the Trigger Input on the AWG710. Connect a 50 Ω BNC coaxial cable to the BNC–T adapter. Connect the opposite end of the BNC cable to the CH2 input on the oscilloscope.

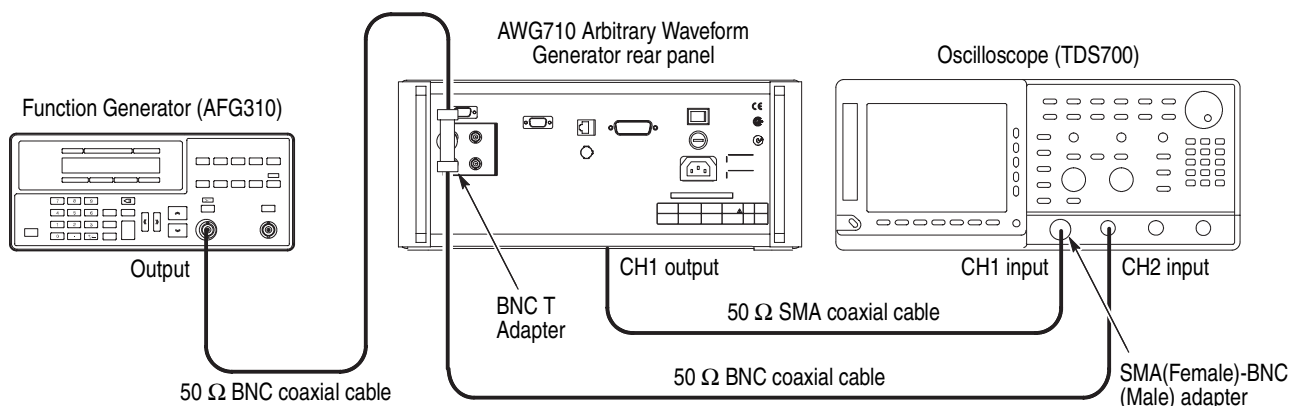

Figure B-49: Trigger input initial test hookup

3. Set the oscilloscope controls as follows:

Vertical	CH1 and CH2
CH1 and CH2 coupling	DC
CH1 scale	500 mV/div
CH2 scale	2 V/div

CH1 input impedance	50 Ω
CH2 input impedance	1 M Ω
Horizontal	
Sweep	1 ms/div
Trigger	
Source	CH1
Coupling	DC
Slope	Positive
Level	+100 mV
Mode	Auto

- a. Set the function generator controls as follows:

Function	DC
Mode	Continuous
Output	Off

- b. Push **UTILITY** (front-panel)→**System** (bottom)→**Factory Reset** (side)→**OK** (side).
- c. Push **SETUP** (front-panel)→**Run Mode** (bottom)→**Gated** (side).
- d. Load the TRIG.WFM file.

Refer to *Loading Files* on page B-62 for file loading procedures.

- 4. Push the **RUN** and **CH1 OUT** buttons.

The LEDs above the RUN button and CH1 output connector are on.

- 5. Set the trigger level to 5 V by the following substeps below:

- a. Push **SETUP** (front-panel)→**Trigger** (bottom)→**Level** (side).
- b. Push **5** and **ENTER** keys in this order.

- 6. Set the trigger input signal level to 4.65 V by the following substeps below:

- a. Turn on the function generator output.
- b. Select offset by pressing the **OFFSET** button of function generator.
- c. Set the DC waveform high level to 4.65 V by using cursor keys.
- d. Check that no waveform is displayed on the oscilloscope as shown in Figure B-50.

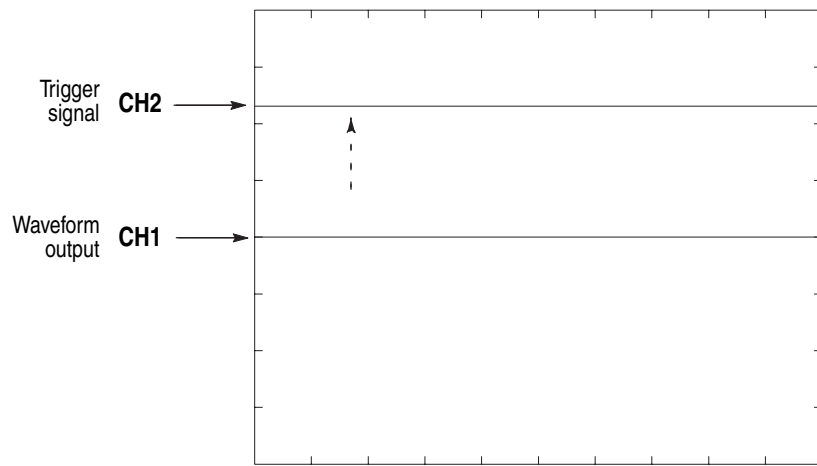

Figure B-50: Trigger signal and waveform output (+5 V check 1)

- e. Change the pulse waveform high level to 5.35 V by using cursor keys.
- f. Check that sine waves are displayed on the oscilloscope as shown in Figure B-41.

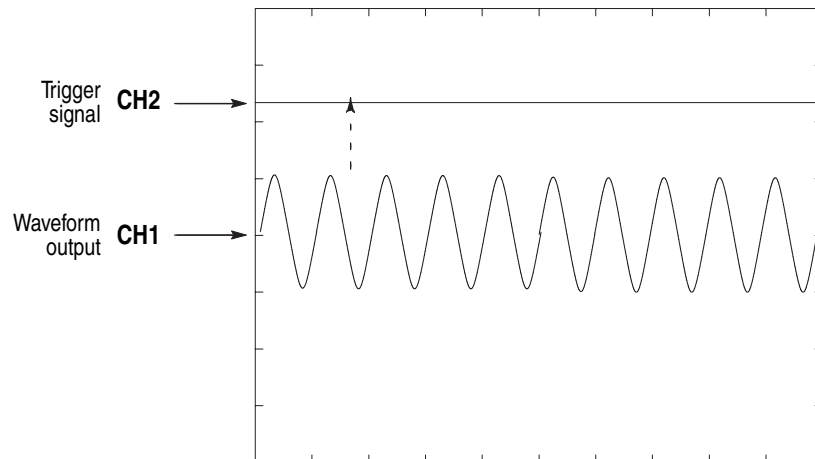

Figure B-51: Trigger signal and waveform output (+5 V check 2)

7. Follow the substeps below to check trigger level accuracy at -5 V:
 - a. Push **-**, **5** and **ENTER** keys in this order.
 - b. Set the DC waveform low level of function generator to -5.35 V by using cursor keys.

- c. Check that no waveform is being displayed on the oscilloscope as shown in Figure B-52.

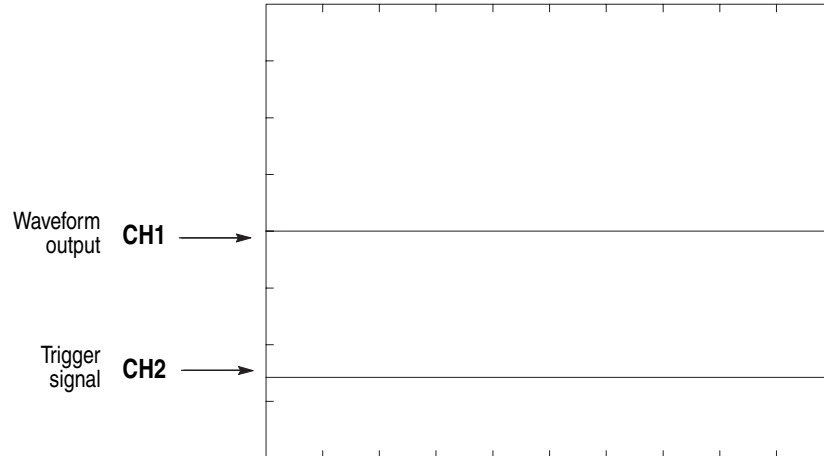

Figure B-52: Trigger signal and waveform output (-5 V check 1)

- d. Change the pulse waveform low level of function generator to -4.65 V by using cursor keys.
- e. Check that sine waves are displayed on the oscilloscope as shown in Figure B-53.

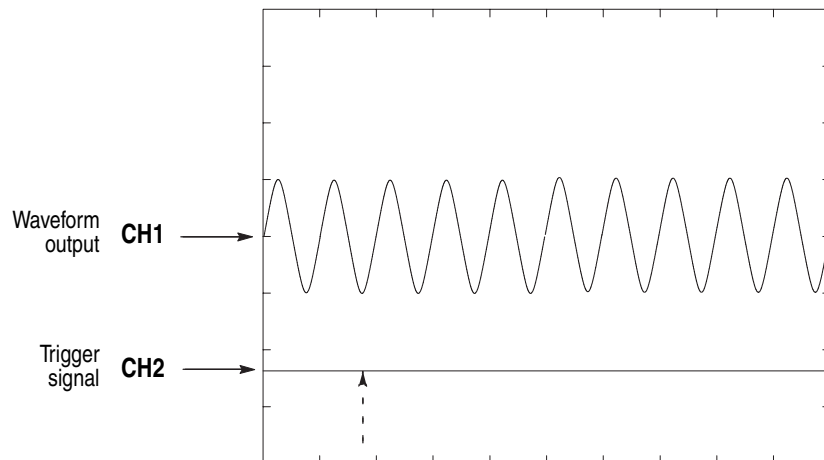

Figure B-53: Trigger signal and waveform output (-5 V check 2)

- 8. Push the **RUN** button and the CH1 button to turn off the RUN LED.
- 9. Turn off the function generator output, disconnect the function generator.

Event Input and Enhanced Mode Tests

These procedures check the event input signals and enhanced mode operation.

NOTE. The event input check with strobe off and the strobe input check are structured as a continuous test. After Check Event Input with Strobe Off, the next test uses the connections and oscilloscope settings from the previous test.

Check Event Input with Strobe Off

Equipment required	A 50 Ω SMA coaxial cable, a SMA(Fe)–BNC(Ma) adapter an oscilloscope (TDS700), and custom–made ground closure. See Figure B-37 for the connections.
Prerequisites	The AWG710 Arbitrary Waveform Generator must meet the prerequisites listed on page B-61.

Do the following steps to install the test hookup and set the test equipment controls:

1. Use a 50Ω SMA coaxial cable and a SMA(Fe)–BNC(Fe) adapter to connect the AWG710 Arbitrary Waveform Generator **CH1** output connector to the oscilloscope CH1 input connector (see Figure B-54).

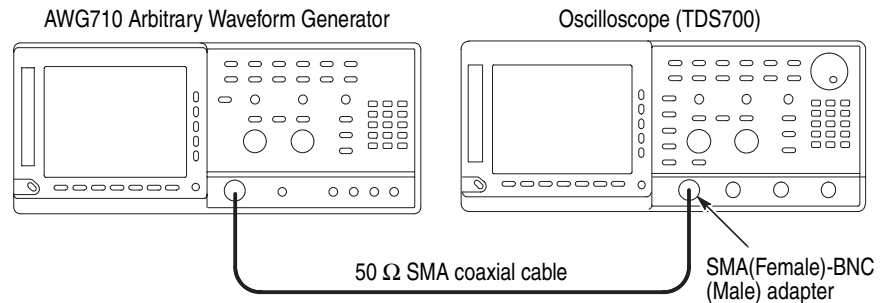

Figure B-54: Event input and enhanced mode initial test hookup

2. Connect the ground closure to the EVENT IN connector on the AWG710 Arbitrary Waveform Generator rear panel.

3. Set the oscilloscope controls as follows:

Vertical	CH1
CH1 coupling.....	DC
CH1 scale	200 mV/div
CH1 input impedance	50 Ω
Horizontal	
Sweep.....	500 ns/div or 400 ns/div
Trigger	
Source.....	CH1
Coupling	DC
Slope.....	Positive
Level	+100 mV
Mode.....	Auto

4. Set all the switches of the ground closure to open.

5. Follow the substeps below to set the AWG710 Arbitrary Waveform Generator controls and select the sequence file:

- a. Push **UTILITY** (front-panel)→**System** (bottom)→**Factory Reset** (side)→**OK** (side).
- b. Load the PT_EVENT.SEQ file.

Refer to *Loading Files* on page B-62 for file loading procedures.

- c. Push **SETUP** (front-panel)→**Run Mode** (bottom)→**Enhanced** (side) to set the enhanced mode.

6. Push the **RUN** and **CH1 OUT** buttons.

The LEDs above the RUN button and CH1 output connector are on.

7. Check the EVENT IN connector pin 0 input:

- a. Verify that a waveform displayed on the oscilloscope has the same amplitude as shown in Figure B-55.

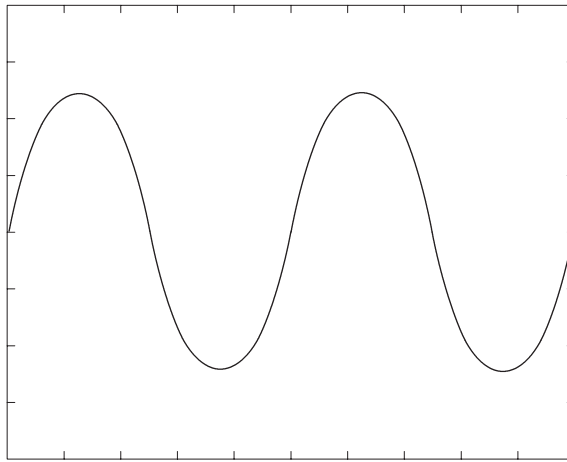

Figure B-55: Waveform while all ground disclosure switches are open

- b.** Close the SW1 of the ground closure to generate an event signal on the EVENT IN connector pin 0.
- c.** Verify that the oscilloscope displays the waveform as shown in Figure B-56 and that the waveform amplitude is the half size of Figure B-55.

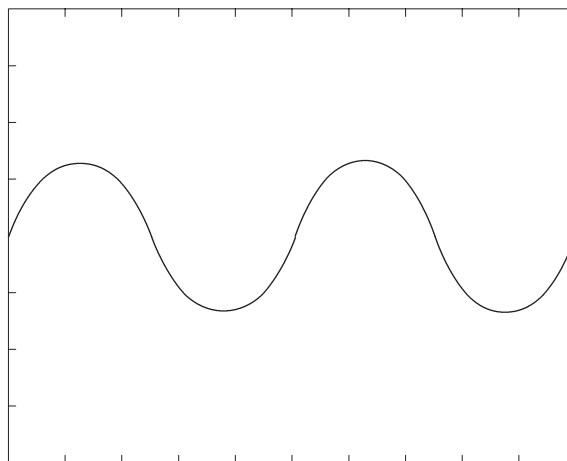

Figure B-56: Waveform output when the SW1 is closed

- d.** Open SW1 of the ground closure to degenerate the event signal.
 - e.** Verify that the oscilloscope displays the waveform in Figure B-55.
- 8.** Check the EVENT IN connector pin 1 input:

- a. Close SW2 of the ground closure to generate an event signal on the EVENT IN connector pin 1.
- b. Verify that the oscilloscope displays the waveform as shown in Figure B-57.

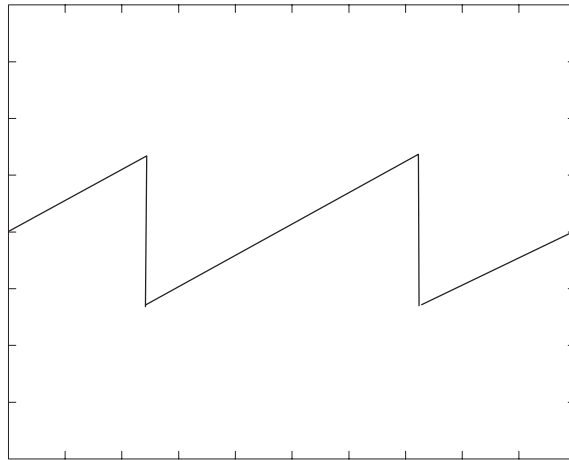

Figure B-57: Waveform output when SW2 is closed

- c. Open the SW2 of the ground closure to degenerate the event signal.
 - d. Verify that the oscilloscope displays the waveform shown in Figure B-55.
9. Check the EVENT IN connector pin 2 input:
- a. Close SW3 of the ground closure to generate an event signal on the EVENT IN connector pin 2.
 - b. Verify that the oscilloscope displays the waveform shown in Figure B-58.

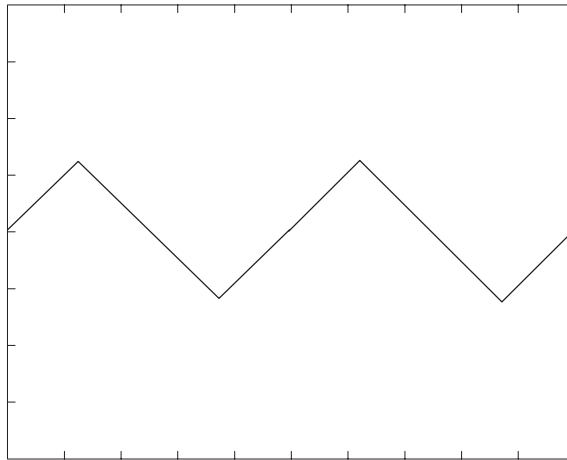

Figure B-58: Waveform output when the SW3 is closed

- c. Open SW3 of the ground closure to degenerate the event signal.
 - d. Verify that the oscilloscope displays the waveform in Figure B-55.
- 10.** Check the EVENT IN connector pin 3 input:
- a. Close the SW4 of the ground closure to generate an event signal on the EVENT IN connector pin 3.
 - b. Verify that the oscilloscope displays the waveform shown in Figure B-59.

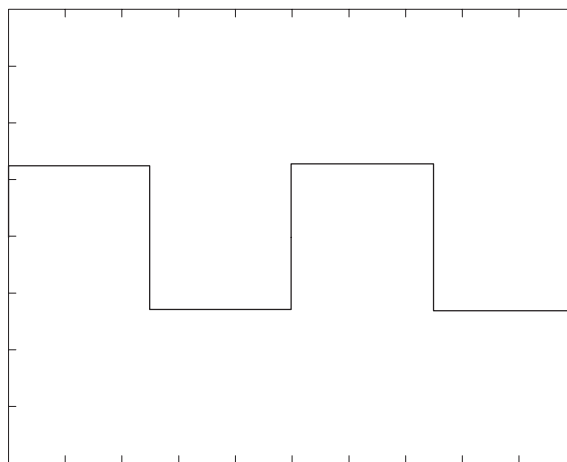

Figure B-59: Waveform output when SW4 is closed

- c. Open SW4 of the ground closure to degenerate the event signal.

d. Verify that the oscilloscope displays the waveform in Figure B-55.

11. Retain the test hookup and control settings.

Check Strobe Input

Use the test hookup and oscilloscope settings from previous check.

1. Follow the substeps below to set the AWG710 Arbitrary Waveform Generator controls and select the sequence file:

a. Push **UTILITY** (front-panel)→**System** (bottom)→**Factory Reset** (side)→**OK** (side).

b. Load the PT_STROB.SEQ file.

Refer to *Loading Files* on page B-62 for file loading procedures.

c. Push **SETUP** (front-panel)→**Run Mode** (bottom)→**Enhanced** (side) to set the run mode to enhanced.

2. Push the **RUN** and **CH1 OUT** buttons.

The LEDs above the RUN button and CH1 output connector are on.

3. Check the EVENT IN connector strobe pin input:

a. Verify that the waveform displayed on the oscilloscope has the same amplitude as shown in Figure B-60.

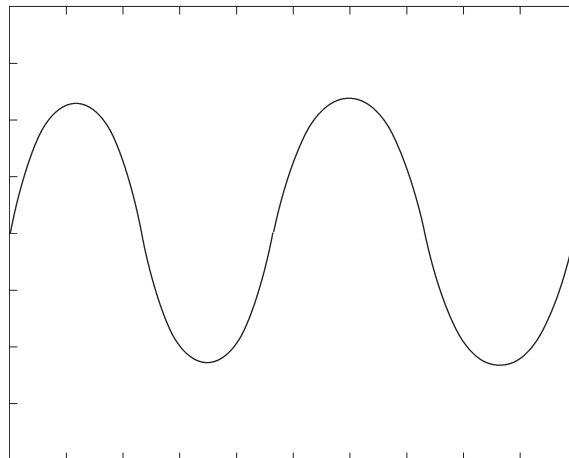

Figure B-60: Initial waveform output

b. Close SW5 of the ground closure to generate an event signal on the EVENT IN connector strobe pin.

- c. Verify that the oscilloscope displays the DC waveform as shown in Figure B-61.

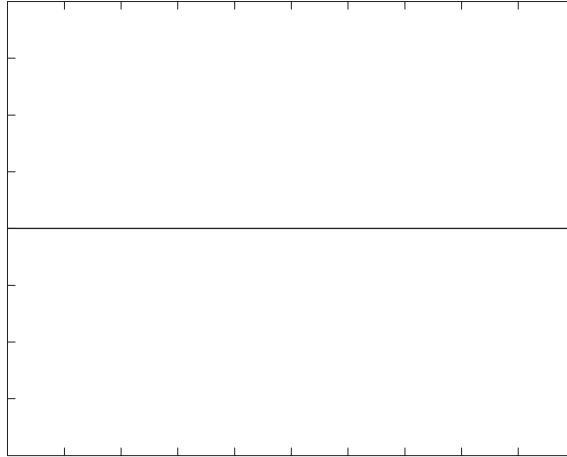

Figure B-61: DC waveform output when the SW5 is closed

- d. Open SW5 of the ground closure to degenerate the strobe signal on the EVENT IN connector strobe pin.
 - e. Verify that the DC waveform is displayed on the oscilloscope.
 - f. Close SW5 of the ground closure again.
 - g. Verify that the oscilloscope displays the waveform as shown in Figure B-60.
4. Push the **CH1 OUT** button to turn off the CH1 LED.
 5. Disconnect the oscilloscope and ground closure.

1/4 Clock Frequency and 10 MHz Reference Input Tests

These procedures check the 10 MHz reference input function of the AWG710 Arbitrary Waveform Generator.

Equipment required	A 50 Ω SMA coaxial cable, A 50 Ω BNC coaxial cable, a SMA(Female)-BNC(Male) adapter, a frequency counter, and a function generator.
Prerequisites	The AWG710 Arbitrary Waveform Generator must meet the prerequisites listed on page B-61.

Do the following steps to install the test hookup and set the test equipment controls:

1. Use a 50 Ω SMA coaxial cable and SMA(Female)-BNC(Male) adapter to connect the AWG710 Arbitrary Waveform Generator 1/4 CLOCK OUT connector to the input A connector on the frequency counter.
2. Use a 50 Ω BNC coaxial cable to connect the AWG710 Arbitrary Waveform Generator 10 MHz REF IN connector to the function generator output connector (see Figure B-62).

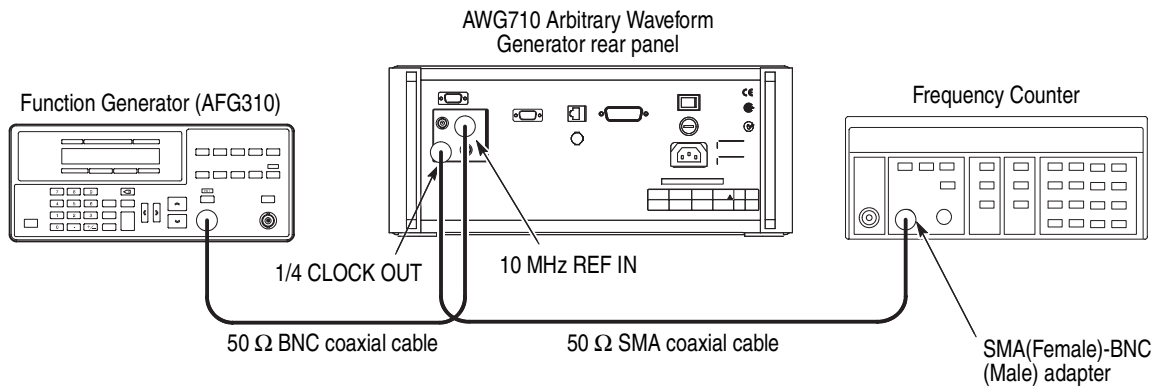

Figure B-62: 1/4 Clock frequency and 10 MHz reference input initial test hookup

- a. Set the frequency counter controls as follows:

INPUT A
 Coupling AC
 FUNCTION A FREQ
 Gate time 0.2 s
 Trigger Level 0 V

b. Set the function generator (AFG310) controls:

Function	Square
Mode	Continuous
Parameters	
Frequency	10 MHz
Amplitude	2.0 V into 50 Ω (4.0 V into 1 M Ω)
Offset	0 V
Output	On

**Check 1/4 Clock
frequency**

1. Follow the substeps below to set the AWG710 Arbitrary Waveform Generator controls and select the waveform file:
 - a. Push **UTILITY** (front-panel)→**System** (bottom)→**Factory Reset** (side)→**OK** (side).
 - b. Load the MODE.WFM file.
Refer to *Loading Files* on page B-62 for file loading procedures.
 - c. Push **HORIZONTAL MENU** (front-panel)→**Clock** (side).
 - d. Push **2, 0, 0** and **M** (SHIFT+7) keys in this order or turn the general purpose knob to set the internal clock frequency to 200 MHz.
2. Push the **RUN** button.
The LED above the RUN button is on.
3. Verify that the frequency counter reading is 50 MHz \pm 50 Hz (using internal reference clock).
4. Retain the test hookup.

**Check 10MHz Reference
Input**

5. Push **HORIZONTAL MENU** (front-panel)→**Clock Ref** (side) so that the AWG710 Arbitrary Waveform Generator reference clock is set to External.
6. Verify that the frequency counter reading is 50.0 MHz \pm 10 kHz (using external reference clock).
7. Change the function generator controls as follows:

Frequency	10.1 MHz
-----------------	----------
8. Check that the frequency counter reading is 50.5 MHz \pm 10 kHz.
9. Turn the function generator output off and disconnect the function generator and frequency counter.

Marker Output Tests

These procedures check the accuracy of the AWG710 Arbitrary Waveform Generator marker output level.

NOTE. Connect a 50 Ω SMA terminator to the inverted marker output connector during the marker output tests.

Equipment required	A 50 Ω BNC coaxial cable, a 50 Ω precision terminator, a SMA(Ma)–BNC(Fe) adapters, BNC (female)–to–dual banana adapter, and a digital multimeter (DMM).
Prerequisites	The AWG710 Arbitrary Waveform Generator must meet the prerequisites listed on page B-61.

Do the following steps to install the test hookup and set the test equipment controls:

1. Use a 50 Ω BNC coaxial cable, a SMA(Ma)–BNC(Fe) adapter, a 50 Ω precision terminator, and a BNC–to–dual banana adapter to connect the AWG710 Arbitrary Waveform Generator MARKER 1 OUT to the DMM input connector (see Figure B-63).

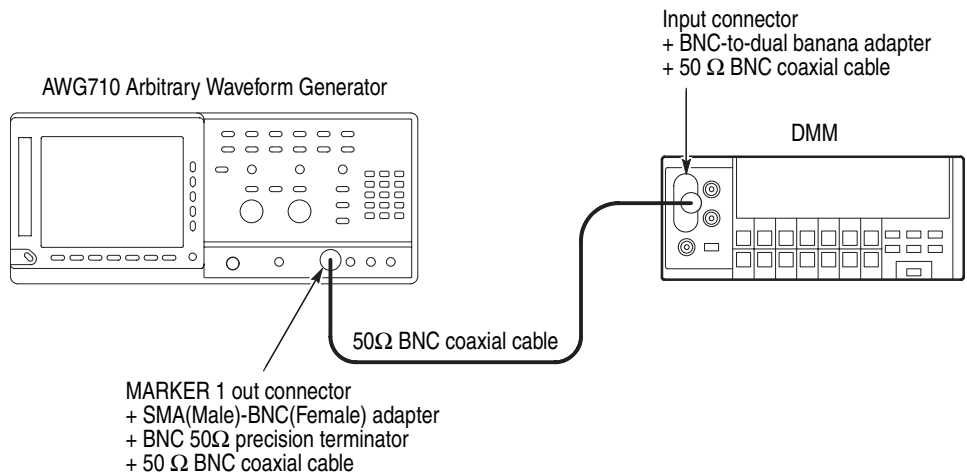

Figure B-63: Marker output initial test hookup

2. Set the DMM controls as follows:

Mode VDC
 Range Auto
 Input Front

3. Follow the substeps below to set the AWG710 Arbitrary Waveform Generator controls and to select the sequence file:

- a. Push **UTILITY** (front-panel)→**System** (bottom)→**Factory Reset** (side)→**OK** (side).
- b. Push **SETUP** (front-panel)→**Run Mode** (bottom)→**Enhanced** (side).

The AWG710 Arbitrary Waveform Generator is set to enhanced mode.

c. Load the AMP1.SEQ file.

Refer to *Loading Files* on page B-62 for file loading procedures.

4. Push the **RUN** button.

The LEDs above the RUN button is on.

5. Do the following substeps to set the AWG710 Arbitrary Waveform Generator marker output high level setting:

- a. Push **VERTICAL MENU** (front-panel)→**Marker...** (side)→**Marker 1 High Level** (side).
- b. Push **3**, **,**, **0** and **ENTER** keys in this order or turn the general purpose knob to set the marker level to 3.0 V.
- c. Verify that the marker 1 high level reading on the DMM screen falls within 2.75 V through 3.25 V.
- d. Push the **FORCE EVENT** button.

6. Do the following substeps to set the AWG710 Arbitrary Waveform Generator marker output low level setting:

- a. Push **Marker 1 Low Level** side button.
- b. Push **-**, **1**, **,**, **1** and **ENTER** keys in this order or turn the general purpose knob to set the marker level to -1.1 V.
- c. Verify that the marker 1 low level reading on the DMM screen falls within -1.255 V through -0.945 V.
- d. Push the **FORCE EVENT** button.

7. Do the following substeps to change the connection to check the MARKER1:

- a. Disconnect the 50 Ω precision terminator from the MARKER1 OUT connector.
 - b. Disconnect the cable (with SMA(Ma)-BNC(Fe) adapter and BNC 50 Ω terminator) from MARKER 1 OUT connector.
 - c. Connect the 50 Ω precision terminator to the MARKER 1 OUT (removed in step a).
 - d. Connect the adapter, terminator, and the cable (removed in step b) to the MARKER1 OUT connector.
8. Press Force Event where needed.
 9. Repeat steps 5 and 6 for the AWG710 Arbitrary Waveform Generator MARKER1 OUT.
 10. Repeat steps 5 through 8 for MARKER 2 OUT and MARKER2 OUT.
 11. Disconnect the DMM.

Appendix C: Inspection and Cleaning

Inspect and clean the instrument as often as operating conditions require. The collection of dirt can cause instrument overheating and breakdown. Dirt acts as an insulating blanket, preventing efficient heat dissipation. Dirt also provides an electrical conduction path that can cause an instrument failure, especially under high-humidity conditions.



CAUTION. *To prevent damage avoid the use of chemical cleaning agents that might damage the plastics used in this instrument. Use only deionized water when cleaning the menu buttons or front-panel buttons. Use a ethyl alcohol solution as a cleaner and rinse with deionized water.*

Avoid the use of high pressure compressed air when cleaning dust from the interior of this instrument. (High pressure air can cause ESD.) Instead, use low pressure compressed air (about 9 psi).

Inspection — Exterior

Using Table C-1 as a guide, inspect the outside of the instrument for damage, wear, and missing parts. You should thoroughly check instruments that appear to have been dropped or otherwise abused to verify correct operation and performance. Immediately repair defects that could cause personal injury or lead to further damage to the instrument.

Table C-1: External inspection check list

Item	Inspect for	Repair action
Cabinet, front panel, and cover	Cracks, scratches, deformations, damaged hardware or gaskets	Replace defective module
Front-panel knobs	Missing, damaged, or loose knobs	Repair or replace missing or defective knobs
Connectors	Broken shells, cracked insulation, and deformed contacts. Dirt in connectors	Replace defective modules; clear or wash out dirt
Carrying handle and cabinet feet	Correct operation	Replace defective module
Accessories	Missing items or parts of items, bent pins, broken or frayed cables, and damaged connectors	Replace damaged or missing items, frayed cables, and defective modules

Cleaning Procedure — Exterior



WARNING. *To avoid injury or death, unplug the power cord from line voltage before cleaning the instrument. To avoid getting moisture inside the instrument during external cleaning, use only enough liquid to dampen the cloth or applicator.*

1. Remove loose dust on the outside of the instrument with a lint-free cloth.
2. Remove remaining dirt with a lint free cloth dampened in a general purpose detergent-and-water solution. Do not use abrasive cleaners.
3. Clean the monitor screen with a lint-free cloth dampened with either ethyl alcohol or, preferably, a gentle, general purpose detergent-and-water solution.

Cleaning the Instrument Interior

Only qualified personnel should access the inside of the AWG710&AWG710B for inspection and cleaning, refer to the *Maintenance* section in the AWG710&AWG710B service manual.

Appendix D: Sample Waveforms

The files listed below are included in the route directory of the sample waveform library disk that comes with the instrument.

There are 22 waveform and equation files. If a waveform file (with the extension **.WFM**) has the same name as an equation file (with the extension **.EQU**), the waveform file was derived by compiling that equation file.

Table D-1: Waveform and equation files in the sample disk

No	Waveform name	File name	
1	Gaussian Pulse	GAUSS_P.EQU	GAUSS_P.WFM
2	Lorentz Pulse	LORENTZ.EQU	LORENTZ.WFM
3	Sampling Function SIN(X)/X Pulse	SINC.EQU	SINC.WFM
4	Squared Sine Pulse	SQU_SIN.EQU	SQU_SIN.WFM
5	Double Exponential Pulse	D_EXP.EQU	D_EXP.WFM
6	Nyquist Pulse	NYQUIST.EQU	NYQUIST.WFM
7	Linear Frequency Sweep	LIN_SWP.EQU	LIN_SWP.WFM
8	Log Frequency Sweep	LOG_SWP.EQU	LOG_SWP.WFM
9	Amplitude Modulation	AM.EQU	AM.WFM
10	Frequency Modulation	FM.EQU	FM.WFM
11	Pulse Width Modulation		PWM.WFM
12	Pseudo-random Pulse		PRBS9.WFM
13	Waveform for Magnetic Disk Signal		DSK.WFM
14	Isolated pulse for Disk application	PR4.EQU	
15	Isolated pulse for Disk application	EPR4.EQU	
16	Isolated pulse for Disk application	E2PR4.EQU	
17	Isolated pulse for Network application		E1.WFM
18	Isolated pulse for Network application		DS1.WFM
19	Isolated pulse for Network application		DS1A.WFM
20	Isolated pulse for Network application		DS2.WFM
21	Isolated pulse for Network application		DS3.WFM
22	Isolated pulse for Network application		STS-1.WFM

These sample waveform and equation files can be copied, distributed, or modified according to your purposes.

Waveform File Descriptions

This subsection describes the 22 representative waveform files. Some of the waveform files were obtained by creating an equation file in the equation editor and then compiling it to create a waveform file. Others were created in the waveform editor or disk application. To output a waveform file, select the file in the SETUP menu.

Table D-2: Gaussian pulse

	File name	GAUSS_P.WFM	Made with equation editor
Equation	size = 1000 clock = 1e9 'pulse width k0 = 30e '9'peak location k1 = 500e-9 "gauss_p.wfm" = exp(-log(2) * ((2* (time - k1) / k0) ^ 2))		
Descriptions	The waveform that is generated when the pulse width is t_{w50} and the peak location is 0 can be expressed as: $V(t) = \exp\left\{-\ln(2) \cdot \left(\frac{2t}{t_{w50}}\right)^2\right\}$ Substituting $\sigma = \frac{t_{w50}}{2\sqrt{2\ln(2)}}$ gives, $f(t) = \exp\left(-\frac{t^2}{2\sigma^2}\right)$ and taking the Fourier transform gives: $F(j\omega) = \sqrt{2\pi}\sigma \cdot \exp\left(-\frac{\omega^2\sigma^2}{2}\right)$ This shows that this signal has a form in the frequency domain as well.		
Example	When t_{w50} is 30 ns, the bandwidth will be 10.4 MHz.		
Settings	Waveform points: 640, Clock frequency: 1.0 GHz, Output time: 640 ns		

Table D-3: Lorentz pulse

	File name LORENTZ_P.WFM	Made with equation editor
Equation	size = 1024 clock = 1e9 'pulse width k0 = 20e-9 'peak location k1 = 512e-9 "lorentz.wfm" = 1 / (1+(2*(time - k1) / k0) ^ 2)	
Descriptions	When the pulse width is taken to be tw50, the waveform can be expressed by the following formula: $V(t) = \frac{1}{1 + \left(2 \frac{t}{t_{w50}}\right)^2}$	
Settings	Waveform points: 1024, Clock frequency: 1.0 GHz, Output time: 1024 ns	

Table D-4: Sampling function SIN(X)/X pulse

	File name SINC.WFM	Made with equation editor
Equation	size = 2048 clock = 1e9 'sine frequency k0 = 50e6 'peak location k1 = 1024e-9 "sinc.wfm" = sinc(2 * pi * k0 * (time - k1))	
Descriptions	In general, this waveform is expressed by the following formula: $V(t) = \frac{\sin(2\pi ft)}{2\pi ft}$ This is the impulse response for the ideal low pass filter for the frequency bandwidth f. At least 42 periods are required to use a vertical resolution of 8 bits.	
Settings	Waveform points: 2048, Clock frequency: 1.0 GHz, Output time: 2048 ns	

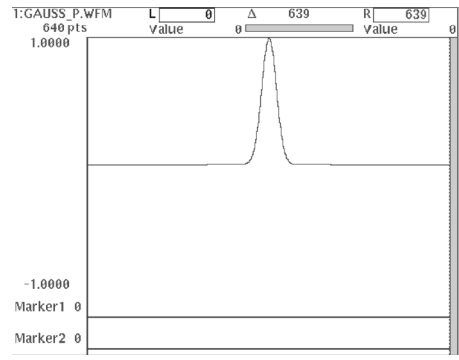
Table D-5: Squared sine pulse

	File name SQU_SIN.WFM	Made with equation editor
Equation <pre> clock = 1e9 size = 412 "tmp1" = 0 size = 200 "tmp2" = (cos (2 * pi * (scale - 0.5)) + 1) / 2 "tmp3" = join ("tmp1", "tmp2") "squ_sin.wfm" = join ("tmp3", "tmp1") delete ("tmp1") delete ("tmp2") delete ("tmp3") </pre>		
Descriptions		
Settings	Waveform points: 1024, Clock frequency: 1.0 GHz, Output time: 412 ns	

Table D-6: Double exponential pulse

	File name D_EXP.WFM	Made with equation editor
Equation <pre> clock = 1e9 size = 10240 k1 = 50e-9 'rise time constant k2 = 1000e-9 'fall time constant "tmp" = exp (-time / k2) - exp (-time /k1) "d_exp.efm" = norm ("tmp") delete ("tmp") </pre>		
Descriptions	This is the waveform when a charged capacitor is discharged to the RC circuit. When the time constants for charging and discharging are taken to be τ_1 and τ_2 , respectively, the waveform can be expressed by the following formula: $V(t) = \exp\left(-\frac{t}{\tau_2}\right) - \exp\left(-\frac{t}{\tau_1}\right)$	
Settings	Waveform points: 10240, Clock frequency: 1.0 GHz, Output time: 10240 ns	

Table D-7: Nyquist pulse

	<p>File name NYQUIST.WFM</p>	<p>Made with equation editor</p>
	<p>Equation</p> <pre> clock = 1e9 size = 1024 k0 = 50e-9 'data period k1 = 512e-9 'peak location a = 0.5 'excess bandwidth factor 0 to 0.5 "t" = (time - k1) / k0 "nyquist.wfm" = cos(a * pi * "t") / (1 - (2 * a * "t") ^ 2) * sinc(pi * "t") delete ("t") </pre>	
	<p>Descriptions</p> <p>This is the impulse response of a wave shaping Nyquist filter. The shoulder characteristics of this filter are referred to as "cosine roll-off" characteristics, and the bandwidth used can be varied. This waveform can be expressed by the following formula.</p> $V(t) = \frac{\cos\left(\frac{\pi a t}{T}\right) \sin\left(\frac{\pi t}{T}\right)}{1 - \left(\frac{2 a t}{T}\right)^2} \cdot \frac{\pi t}{T}$ <p>Here T is the data period and a is a value between 0 and 1. A wider band is required for values closer to 1, where ripple is reduced and implementation is easier.</p>	
	<p>Settings</p> <p>Waveform points: 1024, Clock frequency: 1.0 GHz, Output time: 1024 ns</p>	

Table D-8: Linear frequency sweep

	File name	LIN_SWP.WFM	Made with equation editor
Equation	clock = 1e9 size = 8000 k0 = 8e-6 'sweep period k1 = 1e6 'start frequency k2 = 10e6 'end frequency "lin_swp.wfm" = sin(2 * pi * k1 * time + 2 * pi * (k2 - k1) * (time ^ 2)/2/k0)		
Descriptions	This waveform can be expressed generally by the following formula. $V(t) = \sin \left[2\pi f_1 t + 2\pi f_2 \int_0^t \frac{t}{T} dt + \phi_0 \right]$ Here f_1 is the starting frequency, f_2 is the ending frequency, ϕ_0 is the initial phase, and T is the sweep period. To assure that the phases match when this waveform is iterated, the sweep period is set to be close to an integer multiple of the reciprocal of the average frequency $\frac{f_1 + f_2}{2}$.		
Settings	Waveform points: 8000, Clock frequency: 1.0 GHz, Output time: 8000 ns		

Table D-9: Log frequency sweep

	File name	LOG_SWP.WFM	Made with equation editor
Equation	clock = 800e6 size = 8800 k0 = 11e-6 'sweep period k1 = 1e6 'start frequency k2 = 10e6 'end frequency k3 = log (k2 / k1) "log_swp.wfm" = sin(2 * pi * k1 * k0 / k3 * (exp (k3 * scale) - 1))		
Descriptions	This waveform can be expressed generally by the following formula. $V(t) = \sin \left[2\pi f_1 \int_0^t \exp \left(\frac{t}{T} \cdot \ln \frac{f_2}{f_1} \right) dt + \phi_0 \right]$ Here f_1 is the starting frequency, f_2 is the ending frequency, ϕ_0 is the initial phase, and T is the sweep period. To assure that the phases match when this waveform is iterated, the sweep period is set to be close to an integer multiple of the reciprocal of the average frequency $\frac{f_2 - f_1}{\ln \frac{f_2}{f_1}}$.		
Settings	Waveform points: 8800, Clock frequency: 800 MHz, Output time: 11 μs		

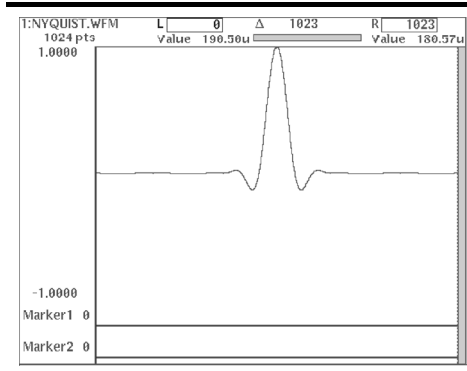
Table D-10: Amplitude modulation

	File name AM.WFM	Made with equation editor
Equation	<pre> clock = 1.28e6 size = 32000 k1 = 4000 'modulation frequency k2 = 10e6 'carrier frequency a = 0.5 'modulation degree "am.wfm" = norm((1 + a * cos(2 * pi * k1 * time)) * cos(2 * pi * k2 * time)) delete ("tmp") </pre>	
Descriptions	This example shows a double sideband (DSB) amplitude modulated waveform with a modulation factor of 0.5. The modulating signal is a cosine wave.	
Settings	Waveform points: 32000, Clock frequency: 128 MHz, Output time: 0.25 ms	

Table D-11: Frequency modulation

	File name FM.WFM	Made with equation editor
Equation	<pre> clock = 819.2e6 size = 32768 k0 = 25e3 'modulation frequency k1 = 100e6 'carrier frequency b = 60.12e3 'frequency deviation "fm.wfm" = sin(2 * pi * k1 * time + b / k0 * sin(2 * pi * k0 * time)) </pre>	
Descriptions	k0 is the frequency of the cosine wave that is used to modulate a sine wave of frequency k1. To assure that the phases match when this waveform is iterated, the carrier frequency times the modulating signal period is set to be an integer. The modulation index is given by k2/k0.	
Settings	Waveform points: 32768, Clock frequency: 819.2 MHz, Output time: 40 μs	

Table D-12: Pulse width modulation

	File name PWM.WFM	Made with waveform editor
Descriptions	The waveform editor is used to create a ramp wave of 1000 periods and a sine wave of 1 period, and these two waveforms are compared to create the PWM.WFM waveform.	
Settings	Waveform points: 32000, Clock frequency: 1.0 GHz, Output time: 32 μ s	

Table D-13: Pseudo-random pulse

	File name PRBS9.WFM	Made with waveform editor
Descriptions	An M-series pseudo-random signal is created using the waveform editor's timing display shift register generator function. Register length = 15 The encoding is NRZ.	
Settings	Waveform points: 4088 $((2^9-1) \times 8)$, Clock frequency: 2.0 GHz, Output time: 2.044 μ s	

Table D-14: Waveform for magnetic disk signal

	File name DSK.WFM	Made with disk application																								
Descriptions	Creates a disk signal pattern with NRZ-I modulation using the disk application. This signal is created with default parameter settings. <table border="0" style="width: 100%;"> <tr> <td style="width: 30%;">Samples/Cell</td> <td style="width: 20%;">20</td> <td style="width: 20%;">NLTS</td> <td style="width: 30%;">0%</td> </tr> <tr> <td>Cell Period</td> <td>20 ns</td> <td>NLTS+</td> <td>0%</td> </tr> <tr> <td>TAA+</td> <td>1.0</td> <td>NLTS-</td> <td>0%</td> </tr> <tr> <td>TAA-</td> <td>-1.0</td> <td>Asymmetry</td> <td>0%</td> </tr> <tr> <td>PW50+</td> <td>50 %</td> <td></td> <td></td> </tr> <tr> <td>PW50-</td> <td>50%</td> <td></td> <td>The encoding is NRZ-I.</td> </tr> </table> A signal with the same pattern is set for the marker 1 as well.		Samples/Cell	20	NLTS	0%	Cell Period	20 ns	NLTS+	0%	TAA+	1.0	NLTS-	0%	TAA-	-1.0	Asymmetry	0%	PW50+	50 %			PW50-	50%		The encoding is NRZ-I.
Samples/Cell	20	NLTS	0%																							
Cell Period	20 ns	NLTS+	0%																							
TAA+	1.0	NLTS-	0%																							
TAA-	-1.0	Asymmetry	0%																							
PW50+	50 %																									
PW50-	50%		The encoding is NRZ-I.																							
Settings	Waveform points: 10220, Clock frequency: 1.0 GHz, Output time: 10220 ns																									

Table D-15: Isolated pulse for disk application

	File name PR4.EQU	Made with equation editor
	Equation <pre> 'PR4 Pulse spcell = 10 'Samples/Cell cperiod = 10e-9 'Cell Period [sec] ncells = 20 'Number of Cells clock = spcell/cperiod 'Samples/Cell / Cell Period [Hz] size = spcell*ncells 'Samples/Cell * Number of Cells k0 = ncells*pi 'Number of Cells * PI k1 = 0.5 a = pi/4 PR4.WFM = a * (sinc(k0*(scale-k1)) + sinc(k0*(scale-k1)+pi)) </pre>	
	Descriptions This is the isolated pulse for the PR4. This sample equation makes the PR4.WFM waveform with 200 waveform points (Samples/Cell × Number of Cells).	
	Settings	

Table D-16: Isolated pulse for disk application

	File name EPR4.EQU	Made with equation editor
	Equation <pre> 'EPR4 Pulse spcell = 10 'Samples/Cell cperiod = 10e-9 'Cell Period [sec] ncells = 20 'Number of Cells clock = spcell/cperiod 'Samples/Cell / Cell Period [Hz] size = spcell*ncells 'Samples/Cell * Number of Cells k0 = ncells*pi 'Number of Cells * PI k1 = 0.5 a = 0.5 EPR4.WFM = a * (sinc(k0*(scale-k1)) + 2*sinc(k0*(scale-k1)+pi) +sinc(k0*(scale-k1)+2*pi)) </pre>	
	Descriptions This is the isolated pulse for the EPR4. This sample equation makes the EPR4.WFM waveform with 200 waveform points (Samples/Cell × Number of Cells).	
	Settings	

Table D-17: Isolated pulse for disk application

	File name	E2PR4.EQU	Made with equation editor
	Equation	<pre> 'E2PR4 Pulse spcell = 10 'Samples/Cell cperiod = 10e-9 'Cell Period [sec] ncells = 20 'Number of Cells clock = spcell/cperiod 'Samples/Cell / Cell Period [Hz] size = spcell*ncells 'Samples/Cell * Number of Cells k0 = ncells*pi 'Number of Cells * PI k1 = 0.5 a = pi*3/32 E2PR4.WFM = a * (sinc(k0*(scale-k1)) + 3*sinc(k0*(scale-k1)+pi) + 3*sinc(k0*(scale-k1)+2*pi) + sinc(k0*(scale-k1)+3*pi)) </pre>	
	Descriptions	This is the isolated pulse for the E2PR4. This sample equation makes the E2PR4.WFM waveform with 200 waveform points (Samples/Cell × Number of Cells).	
	Settings		

Table D-18: Isolated pulse for network application

	File name	E1.WFM	Made with waveform editor
	Descriptions	This is the isolated pulse for the ITU-T E1. The number of waveform points is 84. This isolated pulse is applied to ITU-T E2, ITU-T E3, and T1.102 DS1C.	
	Settings		

Table D-19: Isolated pulse for network application

	File name DS1.WFM	Made with waveform editor
	Descriptions This is the isolated pulse for the T1.102 DS1. The number of waveform points is 64.	
	Settings	

Table D-20: Isolated pulse for network application

	File name DS1A.WFM	Made with waveform editor
	Descriptions This is the isolated pulse for the T1.102 DS1A. The number of waveform points is 64.	
	Settings	

Table D-21: Isolated pulse for network application

	File name DS2.WFM	Made with waveform editor
	Descriptions This is the isolated pulse for the T1.102 DS2. The number of waveform points is 672.	
	Settings	

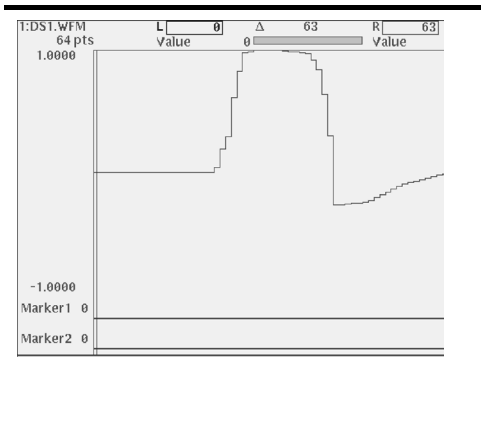
Table D-22: Isolated pulse for network application

	File name	DS3.WFM	Made with waveform editor
	Descriptions	This is the isolated pulse for the T1.102 DS3. The number of waveform points is 336.	
	Settings		

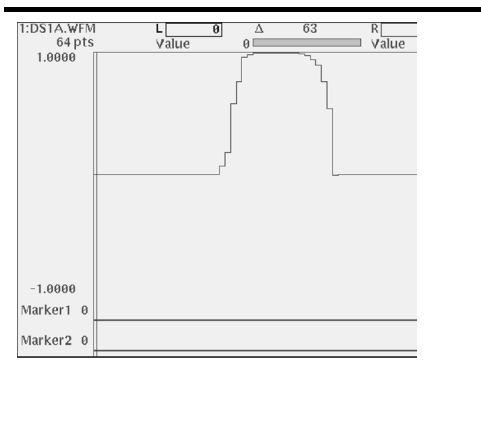
Table D-23: Isolated pulse for network application

	File name	STS-1.WFM	Made with waveform editor
	Descriptions	This is the isolated pulse for the T1.102 STS-1. The number of waveform points is 336.	
	Settings		

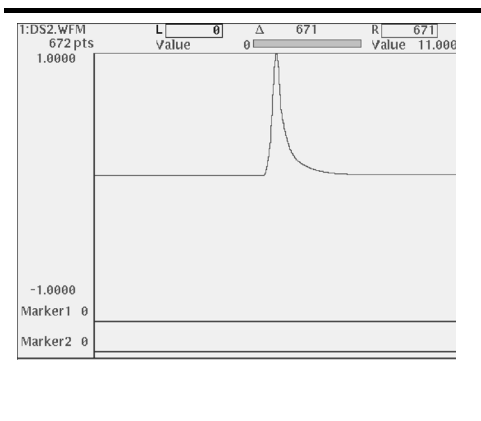
Appendix E: File Transfer Interface Outline

The AWG710&AWG710B Arbitrary Waveform Generator provides the following interfaces for file transfer:

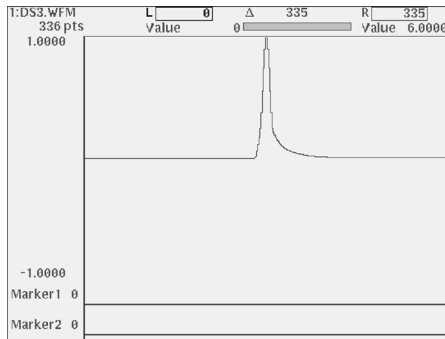
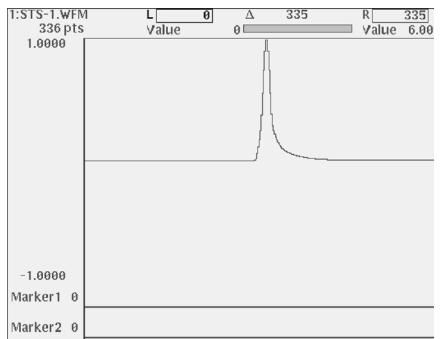
- GPIB
- Floppy disk (FD)
- Ftp
- NFS (Network File System)

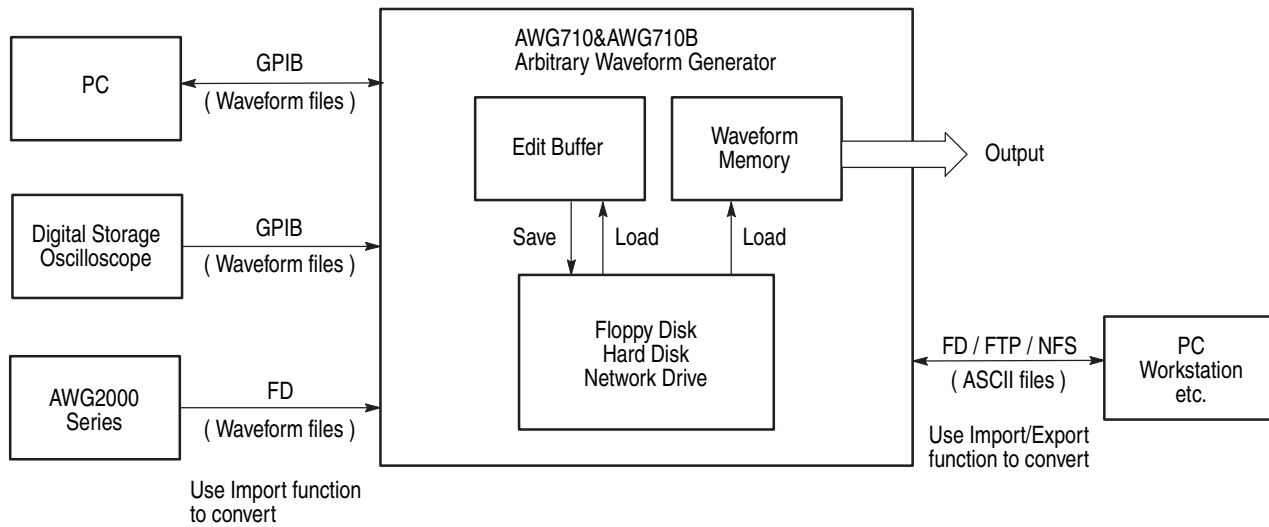

Figure E-1: File transfer interface outline

The AWG710&AWG710B Arbitrary Waveform Generator imports and/or exports files from/to external equipment such as PC, DSO, or AWG2000 Series.

Figure E-1 shows an outline for the interfaces and the file transfer direction.

Appendix F: Miscellaneous

This appendix covers the following items.

- Sampling theorem
- Differentiation
- Integration
- Convolution
- Correlation
- Code Conversion

Sampling Theorem

When the signal is continuous and the highest frequency component of the signal is f_0 , sampling with $T \leq 1/2f_0$ loses none of the data contained in the signal. T is the sampling interval. This theorem is well known as the sampling theorem. If data is created to meet this theorem, the necessary signal can be obtained.

$$X(t) = \sum_{n=-\infty}^{\infty} X(nt) \frac{\sin\{(2\pi/T)(t - nT/2)\}}{(2\pi/T)(t - nT/2)}$$

A continuous analog signal $x(t)$ can be reproduced from the digital data with the above equation. In the Waveform Generator, this is realized using a D/A converter.

Differentiation

The $\text{diff}()$ function calculates the central deviation as the differential value. The equation below expresses the central deviation when the function $f(x)$ is given at even intervals of Δx .

$$f'(x) = \frac{f(x + \Delta x) - f(x - \Delta x)}{(2\Delta x)}$$

In actual practice, when function $f(x)$ is expressed by n values, the differential value $f'(x_i)$ at point x_i is given by the following equation:

$$f'(x_i) = n \frac{|f(x_{i+1}) - f(x_{i-1})|}{2}$$

Here, “ n ” is the number of waveform points and “ i ” is an integer in the range, $i=1, 2, \dots, n$.

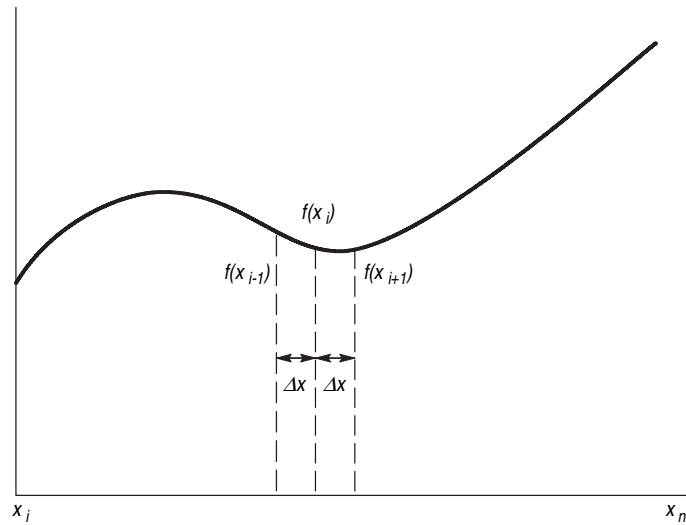

Figure F-1: Equation differentiation

The values at the first and last points are obtained from the following equations rather than from the center deviation:

First point

$$f'(x_1) = \frac{n|-3f(x_1) + 4f(x_2) - f(x_3)|}{2}$$

Last point

$$f'(x_n) = \frac{n|f(x_{n-2}) - 4f(x_{n-1}) + 3f(x_n)|}{2}$$

Integration

The `integ()` function integrates numerically based on a trapezoidal formula. The trapezoidal formula is expressed with the following equation:

$$\int f(x) dx = \sum_{i=1}^n \frac{f(x_{i-1}) + f(x_i)}{2} \cdot \Delta x$$

$$= \Delta \frac{x}{2} \{ \Delta f(x_1) + 2f(x_2) + 2f(x_3) + \dots + 2f(x_{n-1}) + f(x_n) \}$$

Here, n is the number of waveform points and i is an integer in the range $i = 1, 2, \dots, n$.

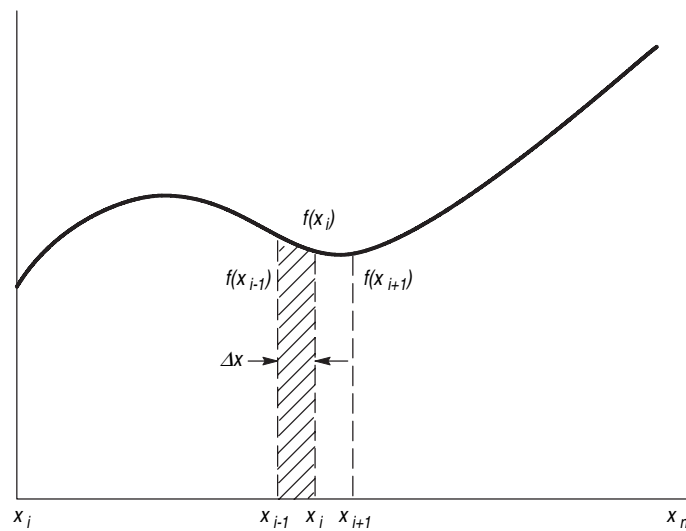

Figure F-2: Equation integration

The integration is actually calculated with the following formula:

$$\int f(x) dx = 1/2 \{ f(x_1) + 2f(x_2) + 2f(x_3) + \dots + 2f(x_{n-1}) + f(x_n) \}$$

However, the imaginary initial value $f(x_0)$ always takes a value of 0.

Convolution

The operation expressed by the following equation is called convolution. With respect to a discrete system, convolution $y(n)$ of a certain waveform $x(n)$ and a second one $h(i)$ is expressed by the following equation. N is the number of items of data.

$$y(n) = \sum_{i=0}^{N-1} x(i)h(n-i)$$

Periodic. The Periodic enables you to specify whether the two-waveforms must be regarded as periodic during calculation. Below is an example showing differences between non-periodic and periodic waveforms.

Waveform A = a0, a1, a2, a3, a4 (5 points)

Waveform B = b0, b1, b2 (3 points)

For nonperiodic case:

$$\begin{aligned} A*B = & \quad \quad \quad a0b0, \\ & \quad \quad \quad a0b1+a1b0, \\ & \quad \quad \quad a0b2+a1b1+a2b0, \\ & \quad \quad \quad a1b2+a2b1+a3b0, \\ & \quad \quad \quad a2b2+a3b1+a4b0, \\ & \quad \quad \quad a3b2+a4b1, \\ & \quad \quad \quad a4b2, \\ & \quad \quad \quad 0, \end{aligned} \quad (8 \text{ points})$$

The data length of the waveform created is the total of the number of points of the two-waveform files.

For periodic case:

$$\begin{aligned} A*B = & \quad \quad \quad a0b2+a1b1+a2b0, \\ & \quad \quad \quad a1b2+a2b1+a3b0, \\ & \quad \quad \quad a2b2+a3b1+a4b0, \\ & \quad \quad \quad a3b2+a4b1+a0b0, \\ & \quad \quad \quad a4b2+a0b1+a1b0, \end{aligned} \quad (5 \text{ points})$$

Waveforms A and B are regarded as periodic during calculation. The count of the operation of sum of products is equivalent to the length of the shorter waveform. The resulting waveform's cycle equals the same as the longer waveform. The actual output segment of the waveform corresponds to one cycle. The starting point value of the waveform equals the sum of products that is obtained with the starting point values of waveforms A and B added.

Correlation

The operation expressed by the following equation is called correlation. With respect to a discrete system, correlation $y(n)$ of a certain waveform $x(n)$ and a second one $h(i)$ is expressed by the following equation. N is the number of items of data.

$$y(n) = \sum_{l=0}^{N-1} x(i)h(n+1)$$

Periodic. Periodic enables you to specify whether the two-waveforms must be regarded as periodic during calculation. Below is an example showing differences between nonperiodic and periodic waveforms.

Waveform A = a0, a1, a2, a3, a4 (5 points)

Waveform B = b0, b1, b2 (3 points)

For nonperiodic case:

$$\begin{aligned} \langle A, B \rangle = & \quad a0b2, \\ & \quad a0b1+a1b2, \\ & \quad a0b0+a1b1+a2b2, \\ & \quad a1b0+a2b1+a3b2, \\ & \quad a2b0+a3b1+a4b2, \\ & \quad a3b0+a4b1, \\ & \quad a4b0, \\ & \quad 0, \end{aligned} \quad (8 \text{ points})$$

The data length of the waveform created is the total of the number of points of the two-waveform files.

For periodic case:

$$\begin{aligned} \langle A, B \rangle = & \quad a0b0+a1b1+a2b2, \\ & \quad a1b0+a2b1+a3b2, \\ & \quad a2b0+a3b1+a4b2, \\ & \quad a3b0+a4b1+a0b2, \\ & \quad a4b0+a0b1+a1b2, \end{aligned} \quad (5 \text{ points})$$

Waveforms A and B are regarded as periodic during calculation. The count of the operation of the sum of the products is equivalent to the length of the shorter waveform. The resulting waveform's cycle equals the same as the longer waveform. The actually output segment of the waveform corresponds to one cycle. The starting point value of the waveform equals the sum of products that is obtained with the starting point values of waveforms A and B added.

Unlike convolution, the result of $A \times B$ and $B \times A$ are different in correlation. $B \times A$ is calculated as follows (B and A are those from the example on page F-5):

For nonperiodic case:

$$\begin{aligned}
 A \times B = & \quad b_0a_4, \\
 & \quad b_0a_3+b_1a_4, \\
 & \quad b_0a_2+b_1a_3+b_2a_4, \\
 & \quad b_0a_1+b_1a_2+b_2a_3, \\
 & \quad b_0a_0+b_1a_1+b_2a_2, \\
 & \quad \quad b_1a_0+b_2a_1, \\
 & \quad \quad \quad b_2a_0, \\
 & \quad 0,
 \end{aligned}
 \tag{8 points}$$

For periodic case:

$$\begin{aligned}
 A \times B = & \quad b_0a_0+b_1a_1+b_2a_2, \\
 & \quad b_0a_4+b_1a_0+b_2a_1, \\
 & \quad b_0a_3+b_1a_4+b_2a_0, \\
 & \quad b_0a_2+b_1a_3+b_2a_4, \\
 & \quad b_0a_1+b_1a_2+b_2a_3,
 \end{aligned}
 \tag{5 points}$$

Waveforms A and B are regarded as periodic during calculation. The count of the operation of sum of products is equivalent to the length of the shorter waveform. The resulting waveform's cycle equals the same as the longer waveform. The actual output segment of the waveform corresponds to one cycle. The starting point value of the waveform equals the sum of the products that is obtained with the starting point values of waveforms A and B added.

Code Conversion

On the AWG710&AWG710B Arbitrary Waveform Generator, it is possible to select the coding system used when pattern strings are output. If the code will be affected by the immediately preceding data, the data item just before the first item of data will be calculated as 0. The following tables show the coding systems.

Using the code conversion table, bit pattern can be converted to another code. Figure F-3 shows an image of how the code conversion table is used.

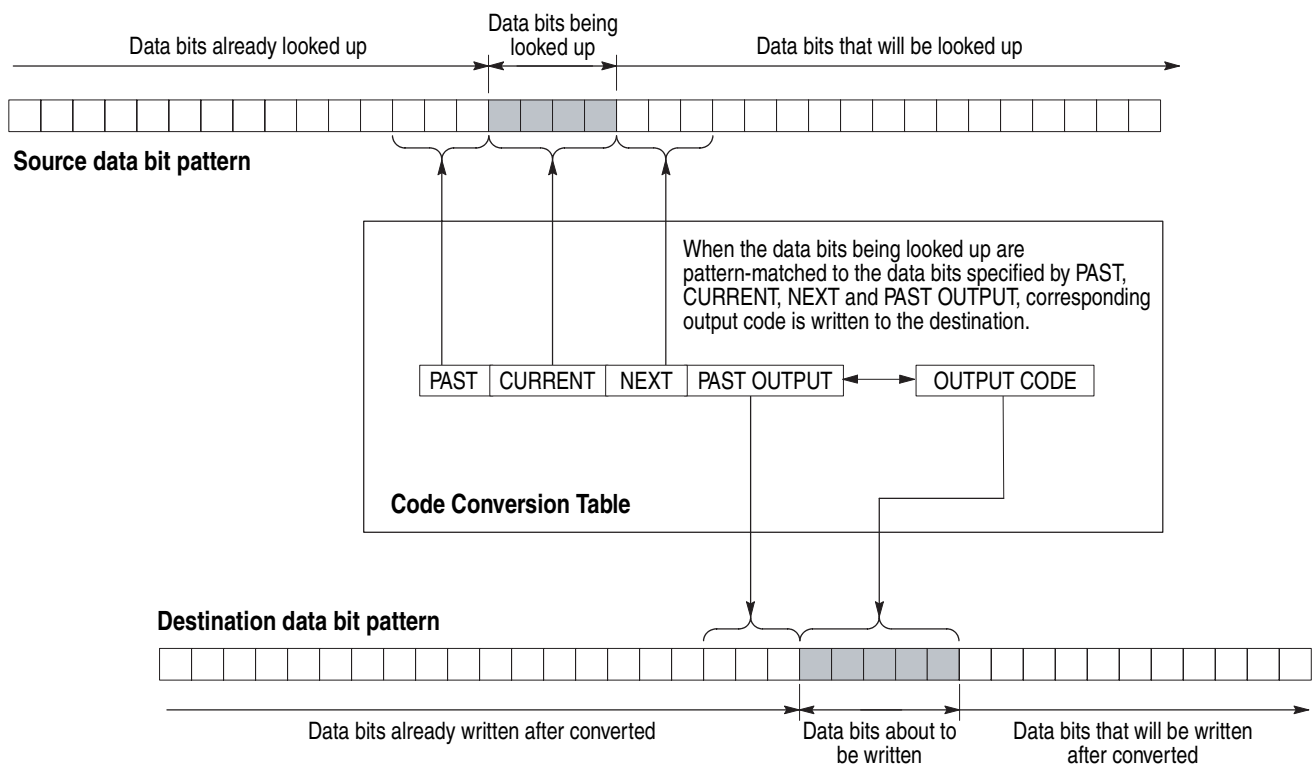

Figure F-3: Conversion image example

Examples

The following examples show data bits to be written. Input and output data bit pattern example follows each table.

- Inverting bit of the **NRZ** data.

Past	Current	Next	P.OUT	Output code
	0			1
	1			0

Example									
Input	0	1	0	0	1	1	0	0	0
Output	1	0	1	1	0	0	1	1	1

- Converting NRZ data to **NRZI**.

Past	Current	Next	P.OUT	Output code
	1		0	1
	1		1	0
	0		0	0
	0		1	1

Example									
Input	0	1	0	0	1	1	0	0	0
Output	0	1	1	1	0	1	1	1	1

- Converting NRZ data to **NRZI**. Two bits are generated for each input bit.

Past	Current	Next	P. OUT	Output code
	1		0	01
	1		1	10
	0		0	00
	0		1	11

Example

Input	0	1	0	0	1	1	0	0	0
Output	00	01	11	11	10	01	11	11	11

- Converting NRZ data to **FM**. Two bits are generated for each input bit.

Past	Current	Next	P. OUT	Output code
	0		0	11
	0		1	00
	1		0	10
	1		1	01

Example

Input	0	1	0	0	1	1	0	0	0
Output	11	01	00	11	01	01	00	11	00

- Converting NRZ data to **BI-PHASE**. Two bits are generated for each input bit.

Past	Current	Next	P. OUT	Output code
	0			01
	1			10

Example

Input	0	1	0	0	1	1	0	0	0
Output	01	10	01	01	10	10	01	01	01

- Converting NRZ data to **RZ**. Two bits are generated for each input bit.

Past	Current	Next	P. OUT	Output code
	0			00
	1			10

Example

Input	0	1	0	0	1	1	0	0	0
Output	00	10	00	00	10	10	00	00	00

- The output bit is always set to 1 when input bit changes from 1 to 0 or 0 to 1.

Past	Current	Next	P. OUT	Output code
0	1			1
1	0			1
	1			0
	0			0

Example

Input	0	1	0	0	1	1	0	0	0
Output	0	1	1	0	1	0	1	0	0

- Converting NRZ data to **1-7 RLL** (Run-length Limited Codes).

Past	Current	Next	P. OUT	Output code
	0000		1	100000
	0000		0	011111
	0001		00	111111

Past	Current	Next	P. OUT	Output code
	0001		01	111111
	0001		10	000000
	0001		11	000000
	0010		01	111110
	0010		10	000001
	0010		00	111110
	0010		11	000001
	0011		1	100001
	0011		0	011110
	01		1	100
	01		0	011
	10		01	111
	10		10	000
	10		00	111
	10		11	000
	11		01	110
	11		10	001
	11		00	110
	11		11	001
	0			0
	1			1

Example

Input	01	10	11	0010	10	0011	11	0001	0011	10	0000
Output	011	000	110	000001	111	100001	110	000000	011110	000	011111

**Code Conversion Table
Text Files**

The code conversion table is only a text file. You can easily create the code conversion tables using a text editor on your PC or other computer. Refer to pages 3-88 and 3-134 for more information.

nrz.txt	nrzi.txt	nrzi-2.txt
,0,,1 ,1,,0	,1,,0,1 ,1,,1,0 ,0,,0,0 ,0,,1,1	,1,,0,01 ,1,,1,10 ,0,,0,00 ,0,,1,11
fm.txt	bi-phase.txt	rz.txt
,0,,0,11 ,0,,1,00 ,1,,0,10 ,1,,1,01	,0,,01 ,1,,10	,0,,00 ,1,,10
special.txt	1-7rill.txt	
0,1,,1 1,0,,1 ,1,,0 ,0,,0	,0000,,1,100000 ,0000,,0,011111 ,0001,,00,111111 ,0001,,01,111111 ,0001,,10,000000 ,0001,,11,000000 ,0010,,01,111110 ,0010,,10,000001 ,0010,,00,111110 ,0010,,11,000001 ,0011,,1,100001 ,0011,,0,011110 ,01,,1,100 ,01,,0,011 ,10,,01,111 ,10,,10,000 ,10,,00,111 ,10,,11,000 ,11,,01,110 ,11,,10,001 ,11,,00,110 ,11,,11,001 ,0,,0 ,1,,1	

Appendix G: Sequence File Text Format

The sequence file saved by the sequence editor is an ASCII text file having the format described below. You can create a sequence file on a PC or other computer with an ASCII text editor.

```
MAGIC 3002A
LINES <number>
<line description>
<line description>
...
<line description>
TABLE_JUMP 0,0,0,0,0,0,0,0,0,0,0,0,0,0,0
LOGIC_JUMP -1,-1,-1,-1
JUMP_MODE LOGIC
JUMP_TIMING ASYNC
STROBE 0
```

Header

The header line MAGIC 3002A lets the instrument recognize a text file as the sequence. This number must be added to the first line.

Line Descriptions

The LINES provides the information that the sequence is composed of a number of lines. From the third line to the line specified by <number> +2 are the sequence lines you should edit in the in the sequence editor.

The <line description> is composed of 6 fields delimited by comma (,):

```
<F1>, <F2>, <F3>, <F4>, <F5>, <F6>, <F7>
```

CH1 and CH2. The <F1> is a waveform file name for the CH1 and <F2> for the CH2. The waveform file name must be parenthesized with double-quotation.

```
<F1>::=
<F2>::="<waveform file name>" | "<pattern file name>" |
      "<sequence file name>"
```

For example,

```
"SINE.WFM", "TRIANGLE.WFM", ...
"GAUSSN.WFM", "", ...
"", "TRIALGLE.WFM", ...
```

When you do not define a file, NULL string ("") must be placed.

Repeat Count. The <F3> is Repeat Count field.

```
<F3>::=<Repeat Count>|<Infinity>
    <Repeat Count>::= 1 to 65536
    <Infinity>::= 0
```

Enhanced Controls. The <F4> to <F7> are Repeat Count, Wait Trigger, Goto One, Logic Jump, and Goto <N> respectively.

```
<F4>::=<Wait Trigger>
    <Wait Trigger>::= 1 (On)
                    0 (Off)

<F5>::=<Goto One>
    <Goto One>::= 1 (On)
                0 (Off)

<F6>::=<Logic Jump>
    <Logic Jump>::= <Line Number> (range: 1 to 8000)
                    0 (No definition)
                    -1 (Jump to next line)
                    -2 (Table Jump)
```

Note that the Logic Jump setting is effective depending on the jump settings described in next paragraph.

```
<F7>::=<Goto N>
    <Goto N>::= <Line Number>    (Jump to line n, range: 1 to
    8000)
                    0          (Go to next line)
```

Jump Settings

After the line descriptions, you place the jump setting descriptions as follows: They can be omitted when you use the current settings.

```
TABLE_JUMP 0,0,0,0,0,0,0,0,0,0,0,0,0,0,0,0
LOGIC_JUMP -1,-1,-1,-1
JUMP_MODE LOGIC
JUMP_TIMING ASYNC
STROBE 0
```

Jump Table Definition. The 16 entries of the table definition follow the table jump header TABLE_JUMP and a space, and must be delimited by comma (,):

```
TABLE_JUMP <space> <LLLL>, <LLLH>, <LLHL>, <LLHH>, <LHLL>,
<LHLH>, <LHHL>, <LHHH>, <HLLL>, <HLLH>, <HLHL>, <HLHH>, <HLLL>,
<HHLH>, <HHHL>, <HHHH>
```

Each of these entries must be:

```
<Entry>::= <Line Number> (range: 1 to 8000)
          0 (No definition)
```

Logic Jump Definition. The 4 entries of the logic table definition follow the logic jump header LOGIC_JUMP and a space, and must be delimited by comma (,):

```
Logic Jump <space> <Pin0 logic>, <Pin1 logic>,
<Pin2 logic>, <Pin3 logic>

<Pinn logic>::= -1 (for X, don't care),
                0 (for L, low state) or
                1 (for H, high state)
```

Jump Mode Selection. The jump table or logic jump definition you define is effective depending on the jump mode setting as follows:

```
JUMP_MODE <space> <jump mode>

<jump mode>::= TABLE, LOGIC or SOFTWARE
```

Jump Timing and Strobe Settings.

```
JUMP_TIMING <space> <timing>

<timing>::= SYNC or ASYNC

STROBE <space> <strobe>

<strobe>::= 0 (for Off) or
            1 (for On)
```

Examples

Two examples are shown here. They are the text versions of the sequence files that you can find in the *Operating Basics: Tutorial 6* section, beginning on page 2-70.

SUBSEQ.SEQ.

```
MAGIC 3002A
LINES 4
"SQUARE.WFM", "", 40000, 0, 0, 0, 0
"RAMP.WFM", "", 60000, 0, 0, 0, 0
"TRIANGLE.WFM", "", 60000, 0, 0, 0, 0
"SINE.WFM", "", 30000, 0, 0, 0, 0
TABLE_JUMP 0, 0, 0, 0, 0, 0, 0, 0, 0, 0, 0, 0, 0, 0, 0, 0, 0, 0,
LOGIC_JUMP -1, -1, -1, -1,
JUMP_MODE LOGIC
JUMP_TIMING ASYNC
STROBE 0
```

Using the current instrument default settings, you can rewrite the above file as follows:

```
MAGIC 3002A
LINES 4
"SQUARE.WFM", "", 40000
"RAMP.WFM", "", 60000
"TRIANGLE.WFM", "", 60000
"SINE.WFM", "", 30000
```

MAINSEQ.SEQ.

```
MAGIC 3002A
LINES 4
"SUBSEQ.SEQ", "", 2, 1, 0, 0, 0
"RAMP.WFM", "", 0, 0, 0, -1, 0
"TRIANGLE.WFM", "", 40000, 0, 1, 4
"SINE.WFM", "", 60000, 0, 0, 0, 0
TABLE_JUMP 0, 0, 0, 0, 0, 0, 0, 0, 0, 0, 0, 0, 0, 0, 0, 0, 0, 0,
LOGIC_JUMP -1, -1, -1, -1
JUMP_MODE LOGIC
JUMP_TIMING ASYNC
STROBE 0
```



Index

Index

Numbers

- 1/4 Clock frequency tests
 - performance verification, B-98
- 1/4 CLOCK OUT, 3-41
- 10 MHz reference input tests
 - performance verification, B-48, B-98

A

- abs(), 3-200
- Absolute math function, 3-72
- Accessories, 1-6
- acos(), 3-200
- Add math function, 3-73
- Amplitude menu button, 3-38
- Amplitude tests (direct DA out)
 - performance verification, B-27, B-81
- Amplitude tests (direct DA out), (except option 02)
 - performance verification, B-23, B-77
- Amplitude tests (normal out)
 - performance verification, B-19, B-72
- APPL window
 - code conversion, 3-134
 - disk drive waveforms, 3-131
 - jitter composer, 3-147
 - jitter composer parameters, 3-152
 - network waveforms, 3-140
 - overview, 3-131
 - superpose, 3-131
 - superpose parameters, 3-138
- archive, 2-22
- asin(), 3-200
- Asymmetry
 - disk application, 3-138
- atan(), 3-200
- AWG20xx.WFM to Pattern
 - File Conversion, 3-219
- AWG20xx.WFM to Waveform
 - File Conversion, 3-219

B

- B3ZS
 - network application, 3-144
- B6ZS
 - network application, 3-144
- B8ZS
 - network application, 3-144
- Basic concept on communication

- for capturing, 3-181
- basic hardware structure, 2-41
- Basic Keywords menu button, 3-111
- bezel buttons, 2-2, 2-3, 2-8
- BMP
 - hardcopy format, 3-170
- BMP COLOR
 - hardcopy format, 3-170
- BNF (Backus-Naur form), 3-185
- bottom menu buttons, 2-9
- bpf(), 3-189
- brf(), 3-190

C

- Cable connection
 - Synchronous Operation, 3-250
- Calibration, 3-172
 - diagnostics, 3-172
 - self tests, B-4, B-58
- Capturing
 - basic concept on communication, 3-181
 - capturing waveforms, 3-181
- ceil(), 3-200
- Cell Period
 - disk application, 3-138
- Certification
 - specifications, A-25, A-40
- CH1, 3-118
- CH1 / CH2 Digital field, 3-122
- cleaning
 - exterior, C-2
- Cleaning the Instrument Interior, C-2
- CLEAR MENU button, 2-2, 2-3, 2-8
- Clip command, 3-65
- Clock
 - jitter composer application, 3-152
 - clock, 3-205
- Clock field, 3-83
- Clock menu button, 3-40
- Clock Ref menu button, 3-42
- Clock Src button, 3-43
- Clock Src menu button, 3-43
- Close command, 3-59
- CMI
 - network application, 3-144
 - code conversion, 3-89, 3-134
- Code Convert math function, 3-80
- code(), 3-191
- Combination of the file type
 - Waveform Mixing, 3-243
- Command
 - equation programming, 3-185
 - Syntax, 3-185
 - BNF (Backus-Naur form), 3-185
- Command syntax, 3-185

- BNF (Backus-Naur form), 3-185
- Commands
 - Absolute, 3-72
 - Add, 3-73
 - Clip, 3-65
 - Close, 3-59
 - Code Convert, 3-80
 - Compare, 3-74, 3-75
 - Convolution, 3-74, 3-76
 - Copy, 3-61
 - Correlation, 3-74, 3-77
 - Cube, 3-72
 - Cut, 3-61
 - Differential, 3-73
 - Digital Filter, 3-74, 3-78
 - Expand, 3-64
 - Horizontal Invert, 3-65
 - Horizontal Rotate, 3-63
 - Horizontal Shift, 3-62
 - Insert From File, 3-59
 - Integral, 3-73
 - Mul, 3-73
 - Multiple Paste, 3-61
 - New Pattern, 3-58
 - New Waveform, 3-58
 - Normalize, 3-73
 - Numeric Input, 3-71, 3-98
 - Open, 3-58
 - Paste (Insert), 3-61
 - Paste (Replace), 3-61
 - ReSampling, 3-74, 3-79
 - Save, 3-58
 - Save As, 3-58
 - Set Data High/Low, 3-62
 - Set Pattern, 3-68, 3-96
 - Shift Register Generator, 3-66
 - Square, 3-72
 - Square Root, 3-73
 - Standard Waveform, 3-59
 - Sub, 3-73
 - Vertical Invert, 3-65
 - Vertical Scale, 3-64
 - Vertical Shift, 3-63
 - XY View, 3-75, 3-80
- Compare math function, 3-74, 3-75
- compiling equations, 3-115
- Compliances
 - specifications, A-25, A-40
- connecting the power cord, 1-11
- Connecting to GPIB network, 3-160
- Connecto
 - C OUT, 2-7
- Connector
 - 10MHz REF IN, 2-6, 2-7
 - 10MHz REF OUT, 2-6, 2-7
 - MASTER/SLAVE CONNECTION, 2-7
 - T OUT, 2-7
 - VCO OUT, 2-7
 - 1/4 CLOCK OUT, 2-6
 - 100/10BASE-T, 2-6, 2-7
 - C OUT, 2-7
 - DISPLAY MONITOR OUT, 2-6, 2-7
 - EVENT IN, 2-6, 2-7
 - EXT CLOCK IN, 2-7
 - IEEE STD 488, 2-7, 2-6
 - KEYBOARD, 2-7
 - KEYBORD, 2-6
 - T IN, 2-7
 - T OUT, 2-7
 - TRIG IN, 2-6, 2-7
- Continuous menu button, 3-44
- Controls
 - quick edit, 3-101
- Controls and connectors
 - front panel, 2-1
 - rear panel, 2-6
- conv(), 3-191
- Conventions
 - performance verification, B-1, B-55
 - user manual, -xx
- converting captured waveform files, 3-219
- Convolution math function, 3-74, 3-76
- copy, 3-113
- Copy command, 3-61
- copy line, Sequence editor, 3-121
- copy(), 3-192
- copying files, 2-19
- corr(), 3-192
- Correlation math function, 3-74, 3-77
- cos(), 3-200
- cosh(), 3-200
- count down counter pattern, 3-95
- Count Down field, 3-95
- count up counter pattern, 3-95
- Count Up field, 3-95
- creating a new waveform, 2-28
- creating a pattern, 3-94
- creating and editing waveforms, tutorial, 2-56
- creating standard counter patterns, 3-95
- Cube math function, 3-72
- Cursor Link field, 3-84
- Cursor Position field, 3-97
- cursors, 2-30
 - Sequence editor, 3-120
- cut, 3-113
- Cut command, 3-61
- cut line, Sequence editor, 3-121

D

- D1/D2
 - network standard, 3-145
- Data Entry menu button, 3-119
- Data Points
 - jitter composer application, 3-152
- Data Rate
 - jitter composer application, 3-152
- data(), 3-193
- Date and time
 - setup, 3-159

- delete(), 3-194
- deleting files, 2-20
- Diagnostics
 - at power on, 3-174
 - calibration, 3-172
 - error codes, 3-175
 - manual execution, 3-175
 - self tests, B-2, B-56
- dialog box, 2-11
- diff(), 3-194
- Differential math function, 3-73
- Digital Filter math function, 3-74, 3-78
- Direct Out menu button, 3-39
- disk drive waveforms, 3-131, 3-234, 3-242
- Display, Screen
 - setup, 3-158
- Double Windows
 - file operation, 3-230
 - window operation, 3-230
- Double windows
 - copying with, 3-227
- drive and directory menus, 2-18

E

- EASYWAVE.WAV to Waveform
 - File Conversion, 3-220
- edit
 - cursors, 2-30
- edit area, 2-30, 3-93
- edit buffer, waveform memory, 2-36
- Edit menu button, 3-37, 3-111
- edit scope, 2-30, 3-92
- EDIT screen, 2-27
 - bottom buttons, 2-27
- edit windows, multiple, 2-31
- editing a waveform, 2-38
- editing table data, 3-106
- editor modes, 2-26
- editor overview, 2-26
- editor screen elements, 2-29
- Enhanced menu button, 3-45
- Enhanced mode tests
 - performance verification, B-37, B-91
- ENTER button, 2-13
- entering equation keywords, 3-114
- Equation editor
 - compiling equations, 3-115
 - cut, copy, paste operations, 3-113
 - entering keywords, 3-114
 - opening the editor, 3-110
 - selecting text, 3-112
 - using external keyboard, 3-114
- Equation programming examples, 3-207
- Equipment list
 - for performance verification, B-7, B-61
- error codes, diagnostic, 3-175
- Ethernet, 1-2
 - FTP link, 3-169

- Mounting remote file system, 3-166
- Network parameter, 3-165
- Network test, 3-164
- Optional Parameters, 3-166
- Setups, 3-162
- EVENT IN connector, 3-125
 - pin assignment, B-9, B-62
- Event input tests
 - performance verification, B-37, B-91
- Event Jump menu button, 3-119
- Execution
 - hardcopy, 3-171
- Exiting
 - quick edit, 3-103
- exiting an editor, 2-33
- exp(), 3-200
- Expand command, 3-64
- expand(), 3-195
- Extended Operation menu button, 3-50
- external keyboard setup, 3-155
- extract, 2-23
- extract(), 3-195

F

- Factory reset, 3-159
- Fall Time
 - jitter composer application, 3-152
- FG Mode, 3-233
- FG mode
 - Amplitude, 3-237
 - change the mode, 3-234
 - Durt, 3-237
 - Frequency, 3-236
 - Frequency resolution, 3-239
 - Marker signal, 3-238
 - Offset, 3-237
 - Polarity, 3-237
 - screen, 3-234
 - Waveform type, 3-235
- Fiber Channel
 - network standard, 3-145
- file attributes, 3-229
- File Conversion
 - AWG20xx.WFM to Pattern, 3-219
 - AWG20xx.WFM to Waveform, 3-219
 - EASYWAVE.WAV to Waveform, 3-220
 - Pattern to Waveform, 3-221
 - TDS.ISF to Waveform, 3-220
 - TDS.WFM to Waveform, 3-219
 - text file to Waveform, 3-220
 - Waveform to text file, 3-221
 - Waveform to text file with marker, 3-221
- File list update
 - for floppy disk, 3-226, B-10, B-63
- file management, 2-17
- File menu button, 3-58, 3-87, 3-111, 3-119
- File name
 - hardcopy, 3-172

- file type extensions, 2-17
- Filter Through menu button, 3-38
- floor(), 3-200
- floppy disk drive, 2-2, 2-3
- floppy disk usage, 3-157
- Floppy diskm
 - performance verification, B-11, B-64
- fname.clock, 3-205
- fname.size, 3-205
- Focused Color
 - setup, 3-158
- Focused color, 1-3
- for/to, 3-196
- Form fields
 - CH1, 3-118
 - CH1 / CH2 Digital, 3-122
 - Clock, 3-83
 - Count Down, 3-95
 - Count Up, 3-95
 - Cursor Link, 3-84
 - Cursor Position, 3-97
 - Goto N, 3-118
 - Goto One, 3-123
 - Graycode, 3-95
 - Grid, 3-84
 - Horizontal Unit, 3-84
 - Interpolation, 3-84
 - Johnson, 3-95
 - Logic Jump, 3-118, 3-124
 - Pattern, 3-97
 - Repeat Count, 3-118, 3-122
 - Table Type, 3-83
 - Target, 3-97
 - Total Points, 3-83, 3-97
 - Update Mode, 3-84
 - Use Code Table, 3-97
 - View, 3-83
 - Wait Trigger, 3-118, 3-123
- Format as text
 - sequence file, G-1
- formatting a floppy disk, 3-157
- front panel controls, 2-1
- front panel menu buttons, 2-9
- FTP commands, 3-169
- FTP link
 - Ethernet, 3-169
- fuse, 1-11

G

- Gated menu button, 3-45
- general purpose knob, 2-12
- general purpose knob direction, 3-156
- Goto N field, 3-118
- Goto One field, 3-123
- GPIO, 1-2
 - parameters, 3-160
 - procedures for setups, 3-160
- GPIO Interface

- Setups, 3-160
- Graphical waveform editor
 - bottom menu buttons, 3-57
- graphical waveform editor screen, 3-55
- Graycode counter pattern, 3-95
- Graycode field, 3-95
- Grid field, 3-84

H

- Hardcopy, 3-170
 - execution, 3-171
 - file name, 3-172
- Hardcopy format
 - BMP, TIFF, BMP COLOR, TIFF COLOR, 3-170
- Hardcopy setups, 3-170
- HDB3
 - network application, 3-144
- Highlight Color
 - setup, 3-158
- Horizontal Invert command, 3-65
- Horizontal menu button, 3-34, 3-35, 3-40
- Horizontal Rotate command, 3-63
- Horizontal Shift command, 3-62
- Horizontal Unit field, 3-84
- hpf(), 3-197

I

- icons, Setup window, 3-34
- IEEE Std. 488.2-1987, 3-185
- if/then/else, 3-198
- Illegal file format message, 3-36
- Impedance menu button, 3-47
- Import pattern, 3-70
- importing data from file, 3-96
- Importing files, 3-219
- incoming inspection, 1-4
- Insert From File command, 3-59
- insert line, Sequence editor, 3-120
- inspection
 - exterior, C-1
- Inspection and cleaning
 - access, C-2
- inspection and cleaning, C-1
 - compressed air, C-1
- installation, 1-9
- instrument clearance, 1-10
- instrument setup, 2-53
 - Tutorial 1, 2-51
- Instruments
 - supported for waveform capture, 3-181
- int(), 3-200
- integ(), 3-198
- Integral math function, 3-73
- Interior inspection
 - procedures, C-2
- internal calibration, 1-15

Interpolation field, 3-84
 Interval menu button, 3-48
 Isolated pulse
 disk, 3-135
 network, 3-144
 ITU-T
 network standard, 3-145

J

jitter composer, 3-147
 jitter composer parameters, 3-152
 Jitter Deviation
 jitter composer application, 3-152
 Jitter Frequency
 jitter composer application, 3-152
 Jitter Profile
 jitter composer application, 3-152
 Johnson counter pattern, 3-95
 Johnson field, 3-95
 join(), 3-199
 Jump Mode menu button, 3-119

K

keyboard, 1-2
 keyboard functions, 3-156

L

LCM
 Waveform Mixing, 3-246
 Limitation on Using Sequences, 3-128
 Line Edit menu button, 3-119
 line number, Sequence editor, 3-118
 Load A File
 Waveform Mixing, 3-243
 Load A file menu button, 3-243
 Load B File
 Waveform Mixing, 3-243
 Load B File menu button, 3-243
 Load menu button, 3-36
 loading a file, 2-28
 loading a file to edit, 2-28
 loading a waveform, 2-36
 loading a waveform to output, 2-36
 loading files, 2-18
 performance verification, B-9, B-62
 loading setup parameters, 2-40
 locating files, 2-18
 Locked files
 on performance check/adjustment disk, B-11, B-64
 log(), 3-200
 log10(), 3-200
 Logic Jump, 3-125
 Logic Jump field, 3-118, 3-124

Lorentz/Gaussian
 disk application, 3-138
 lpf(), 3-199

M

MAC Address, 3-164
 Main Menu buttons, 2-8
 main SETUP screen, 2-34
 manual diagnostics, 3-175
 Marker
 Waveform Mixing, 3-245
 Marker data, 3-187
 Marker menu button, 3-39, 3-245
 Marker output tests
 performance verification, B-50, B-100
 Math function
 Absolute, 3-72
 Add, 3-73
 Code Convert, 3-80
 Compare, 3-74, 3-75
 Convolution, 3-74, 3-76
 Correlation, 3-74, 3-77
 Cube, 3-72
 Differential, 3-73
 Digital Filter, 3-74, 3-78
 Integral, 3-73
 Mul, 3-73
 Normalize, 3-73
 ReSampling, 3-74, 3-79
 Square, 3-72
 Square Root, 3-73
 Sub, 3-73
 XY View, 3-75, 3-80
 Math functions
 abs(), 3-200, 3-205
 acos(), 3-200
 asin(), 3-200
 atan(), 3-200
 ceil(), 3-200
 cos(), 3-200
 cosh(), 3-200
 exp(), 3-200
 floor(), 3-200
 int(), 3-200
 log(), 3-200
 log10(), 3-200
 max(), 3-200
 min(), 3-201
 noise, 3-201
 pow(), 3-201
 rnd(), 3-201
 round(), 3-201
 saw(), 3-201
 sign(), 3-201
 sin(), 3-201
 sinc(), 3-201
 sinh(), 3-201
 sqr(), 3-201

sqrt(), 3-201
 srnd(), 3-201
 tan(), 3-201
 tanh(), 3-201
 Tri(), 3-201
 Math Functions menu button, 3-111
 Math operators, 3-202
 max(), 3-200
 Mechanism
 quick edit, 3-100
 Menu buttons
 Amplitude, 3-38
 Basic Keywords, 3-111
 Clock, 3-40
 Clock Ref, 3-42
 Continuous, 3-44
 Data Entry, 3-119
 Direct Out, 3-39
 Edit, 3-37, 3-111
 Enhanced, 3-45
 Event Jump, 3-119
 Extended Operation, 3-35
 File, 3-58, 3-87, 3-111, 3-119
 Filter Through, 3-38
 Gated, 3-45
 Horizontal, 3-34, 3-40
 Impedance, 3-47
 Interval, 3-48
 Jump Mode, 3-119
 Line Edit, 3-119
 Load, 3-36
 Marker, 3-39
 Math Functions, 3-111
 More Math Functions, 3-111
 Move Cursor To, 3-119
 Offset, 3-39
 Operation, 3-59, 3-87
 Polarity, 3-47
 Restore Setup, 3-49
 Run Mode, 3-34, 3-44, 3-46
 Save Setup, 3-49
 Save/Restore, 3-34, 3-48, 3-50
 Settings, 3-82, 3-91
 Slope, 3-47
 Tools, 3-72, 3-87
 Trigger, 3-34, 3-46
 Trigger Level, 3-47
 Triggered, 3-44
 Undo!, 3-91, 3-111
 Vertical, 3-34, 3-38
 View, 3-37
 Waveform Functions, 3-111
 Waveform/Sequence, 3-34
 Window, 3-82, 3-91
 Zoom/Pan, 3-81, 3-91
 menu elements, 2-9
 menu operations, 2-8
 Menu Structures, 3-3
 menu system, 2-8
 Message
 record length adjustment, 3-231, 3-232

Message, record length adjustment, 2-22
 min(), 3-201
 MLT3
 network Application, 3-144
 More Math Functions menu button, 3-111
 Mounting remote file system
 Ethernet, 3-166
 Move Cursor To menu button, 3-119
 Moving cursor
 quick edit, 3-104
 Mul math function, 3-73
 multiple edit windows, 2-31
 Multiple Paste command, 3-61

N

Network parameter
 Ethernet, 3-165
 Network standard, 3-145
 D1/D2, 3-145
 Fiber Channel, 3-145
 ITU-T, 3-145
 SDH/Sonet, 3-145
 T1.102, 3-145
 Network test
 Ethernet, 3-164
 network waveforms, 3-140
 Networking
 Ethernet, 3-162
 New Pattern command, 3-58
 New Waveform command, 3-58
 NFS
 Networking, 3-166
 NLTS
 disk application, 3-138
 NLTS-
 disk application, 3-138
 NLTS+
 disk application, 3-138
 noise, 3-201
 norm(), 3-203
 Normalize math function, 3-73
 NRZ
 disk application, 3-134
 NRZI
 disk application, 3-134
 numeric input, 2-12
 Numeric Input command, 3-71, 3-98
 numeric keypad, 2-12

O

Offset menu button, 3-39
 Offset tests (direct DA out)
 performance verification, B-27, B-81
 Offset tests (direct DA out), (except option 02)
 performance verification, B-23, B-77
 Offset tests (normal out)

- performance verification, B-19, B-72
 - ON/STBY
 - button, 2-2, 2-3
 - switch, 1-14, 1-15
 - Open command, 3-58
 - opening multiple edit windows, 2-32
 - opening the Equation editor, 3-110
 - opening the Sequence editor, 3-117
 - opening the SETUP screen, 2-34
 - opening the Setup window, 3-33
 - opening the Table editor, 3-105
 - operating environment, 1-10
 - Operating mode tests
 - performance verification, B-13, B-66
 - Operation menu button, 3-59, 3-87
 - Operators, math, 3-202
 - Option 01 (32MB words memory), 1-8
 - Option 02 (High Bandwidth output), 1-8
 - Option 10 (78 Mb flash disk), 1-8
 - Option 1R (rackmounting), 1-8
 - Option D1 (test result report), 1-8, 1-9
 - optional accessories, 1-6
 - Optional parameters
 - Ethernet, 3-166
 - options, 1-8
 - output parameters, setting, 2-38
 - outputting a signal, 3-51
- P**
- PANEL LOCK LED, 2-2
 - panel lock LED, 2-3
 - Parameters
 - GPIB, 3-160
 - paste, 3-113
 - Paste (Insert) command, 3-61
 - Paste (Replace) command, 3-61
 - paste line, Sequence editor, 3-121
 - Pattern editor, 3-86
 - creating a pattern, 3-94
 - creating counter patterns, 3-95
 - default values, 3-94
 - edit area, 3-93
 - importing data from a file, 3-96
 - Selecting data to edit, 3-92
 - Pattern field, 3-97
 - pattern loading restrictions, 3-36
 - Pattern to Waveform
 - File Conversion, 3-221
 - Performance verification
 - 1/4 clock frequency tests, B-48, B-98
 - 10 MHz reference input tests, B-98
 - amplitude tests (direct DA out), B-81
 - amplitude tests (direct DA out), (except option 02), B-77
 - Amplitude tests (normal out), B-19
 - amplitude tests (normal out), B-72
 - Amplitude tests (option 02), B-27
 - enhanced mode tests, B-37, B-91
 - equipment required, B-7, B-61
 - Event input and Enhanced mode tests, B-37
 - event input tests, B-91
 - External Clock input and VCO Output tests, B-46
 - floppy disk, B-11, B-64
 - loading files, B-9, B-62
 - marker output tests, B-50, B-100
 - offset tests (direct DA out), B-27, B-81
 - offset tests (direct DA out), (except option 02), B-23, B-77
 - offset tests (normal out), B-19, B-72
 - operating mode tests, B-13, B-66
 - prerequisites, B-7, B-61
 - Pulse response tests, B-31
 - pulse response tests, B-85
 - purpose, B-1, B-55
 - rise time tests (direct DA out), B-27, B-81
 - rise time tests (direct DA out), (except option 02), B-23, B-77
 - Synchronous operation tests, B-52
 - test items, B-6, B-60
 - Trigger input tests, B-33
 - trigger input tests, B-87
 - VCO OUT and 10 MHz reference input tests, B-48
 - Performance verificationAmplitude tests (direct DA out), (except option 02), B-23
 - pi, 3-205
 - Pin assignments
 - EVENT IN connector, B-9, B-62
 - pn(), 3-203
 - PN15
 - network application, 3-144, 3-151
 - PN9
 - network application, 3-144, 3-151
 - point(), 3-205
 - Polarity menu button, 3-47
 - popup menu, 2-10
 - pow(), 3-201
 - power connector, 2-6, 2-7
 - power cord identification, 1-12
 - power cord options, 1-5
 - power cord, connecting, 1-11
 - power off, 1-15
 - power On, 1-14
 - power supply fuse holder, 2-6, 2-7
 - poweron diagnostics, 1-15, 3-174
 - PRINCIPLE POWER SWITCH, 2-6, 2-7
 - Procedure
 - inspect interior, C-2
 - Procedures for setups
 - GPIB, 3-160
 - product description, 1-1
 - Programming language
 - abs(), 3-200, 3-205
 - acos(), 3-200
 - asin(), 3-200
 - atan(), 3-200
 - bpf(), 3-189
 - brf(), 3-190
 - ceil(), 3-200
 - clock, 3-205

code(), 3-191
conv(), 3-191
copy(), 3-192
corr(), 3-192
cos(), 3-200
cosh(), 3-200
data(), 3-193
delete(), 3-194
diff(), 3-194
exp(), 3-200
expand(), 3-195
extract(), 3-195
floor(), 3-200
fname.clock, 3-205
fname.size, 3-205
for/to, 3-196
hpf(), 3-197
if/then/else, 3-198
int(), 3-200
integ(), 3-198
join(), 3-199
log(), 3-200
log10(), 3-200
lpf(), 3-199
math operators, 3-202
max(), 3-200
min(), 3-201
noise, 3-201
norm(), 3-203
pi, 3-205
pn(), 3-203
point(), 3-205
pow(), 3-201
rename(), 3-204
rnd(), 3-201
round(), 3-201
saw(), 3-201
sign(), 3-201
sin(), 3-201
sinc(), 3-201
sinh(), 3-201
size, 3-205
sqr(), 3-201
sqrt(), 3-201
srnd(), 3-201
tan(), 3-201
tanh(), 3-201
time(), 3-205
tri(), 3-201
write(), 3-206
Pulse isolated
 disk, 3-135
 network, 3-144
Pulse response tests
 performance verification, B-31, B-85
PW50-
 disk application, 3-138
PW50+
 disk application, 3-138

Q

Quick edit
 controls, 3-101
 exiting, 3-103
 mechanism, 3-100
 moving cursor, 3-104
 renewing edit buffer, 3-104
 screen display, 3-99
 setting parameters, 3-103
 smoothing, 3-101
 start, 3-102
 undo, non-support, 3-104
quick editor functions, tutorial, 2-63
quick view, 2-24
quitting an editor, 2-33

R

Ratio of A
 Waveform Mixing, 3-245
Ratio of A menu button, 3-245
Ratio of B
 Waveform Mixing, 3-245
Ratio of B menu button, 3-245
read only attribute, 2-20
Read Only file attribute, 3-229
Read/Write file attribute, 3-229
rear panel controls, 2-6
Record length adjustment
 message, 3-231, 3-232
Record length adjustment message, 2-22
rename(), 3-204
renaming files, 2-19
Renewing edit buffer
 quick edit, 3-104
repackaging for shipment, 1-16
Repeat Count
 jitter composer application, 3-152
Repeat Count field, 3-118, 3-122
ReSampling math function, 3-74, 3-79
Resetting
 factory reset, 3-159
 secure, 3-159
Restore Setup menu button, 3-49
restoring setup parameters, 2-40
restrictions
 Synchronous Operation, 3-250
Rise Time
 jitter composer application, 3-152
Rise time tests (direct DA out)
 performance verification, B-27, B-81
Rise time tests (direct DA out), (except option 02)
 performance verification, B-23, B-77
rnd(), 3-201
round(), 3-201
Run Mode menu button, 3-34, 3-44

S

- Same as A
 - Waveform Mixing, 3-245
- Same as B
 - Waveform Mixing, 3-246
- Sample waveforms, D-1
- Sample/Cell
 - disk application, 3-138
- Samples/Bit
 - jitter composer application, 3-152
- Save As, 2-22
- Save As command, 3-58
- Save command, 3-58
- Save Mixed Wfm
 - Waveform Mixing, 3-244
- Save Mixed Wfm menu button, 3-244
- Save Setup menu button, 3-49
- save to new file name, 2-22
- Save/Restore menu button, 3-34, 3-35, 3-48
- saving files, 2-21
- saving setup parameters, 2-40
- saw(), 3-201
- scale, 3-205
- Screen Display Enable/Disable
 - setup, 3-158
- screen icons, 2-35
 - SETUP, 2-35
- SDH/Sonet
 - network standard, 3-145
- Secure
 - resetting and removing files, 3-159
- Selecting data to edit, 3-92, 3-93
- selecting text in Equation editor, 3-112
- Self tests
 - at power-on, 1-15
 - calibration, B-4, B-58
 - diagnostics, B-2, B-56
- Sequence editor
 - Async, 3-126
 - copying a line, 3-121
 - cursor movement, 3-120
 - cutting a line, 3-121
 - EVENT IN connector, 3-125
 - inserting a line, 3-120
 - limitations, 3-128
 - line number, 3-118
 - logic jump, 3-125
 - opening the editor, 3-117
 - pastings a line, 3-121
 - Strobe, 3-126
 - Sync, 3-126
 - table jump, 3-125
 - timing, 3-126
- Sequence file
 - text format, G-1
- sequence file load restrictions, 3-36
- Set Data High/Low command, 3-62
- set output parameters, 2-38
- Set Pattern command, 3-68, 3-96
- Setting parameters
 - quick edit, 3-103
- Settings menu button, 3-82, 3-91
- Setup
 - date and time, 3-159
 - Focused Color, 3-158
 - Screen Display Enable/Disable, 3-158
- Setup overview
 - outputting a waveform, 2-39
- setup overview, 2-34
- setup parameters
 - loading from a file, 2-40
 - saving to a file, 2-40
- SETUP screen, 2-34
- Setup window
 - Amplitude, 3-38
 - Clock, 3-40
 - Clock Ref, 3-42
 - Clock Src, 3-43
 - Continuous, 3-44
 - Direct Out, 3-39
 - Edit, 3-37
 - Enhanced, 3-45
 - equation file loading, 3-37
 - Extended Operation, 3-50
 - FG mode, 3-50
 - Filter Through, 3-38
 - Gated, 3-45
 - Horizontal menu, 3-40
 - Impedance, 3-47
 - Interval, 3-48
 - Load, 3-36
 - Marker, 3-39
 - Offset, 3-39
 - opening, 3-33
 - outputting a signal, 3-51
 - Polarity, 3-47
 - Restore Setup, 3-49
 - Run Mode, 3-44
 - Save Setup, 3-49
 - Save/Restore, 3-48
 - sequence file restrictions, 3-36
 - Setup screen elements, 3-33
 - Slope, 3-47
 - Synchronous Operation, 3-50
 - Trigger, 3-46
 - Trigger Level, 3-47
 - Trigger Source, 3-46
 - Triggered, 3-44
 - View, 3-37
 - Waveform Mixing, 3-50
 - waveform/pattern load restrictions, 3-36
 - window icon descriptions, 3-34
- Setups
 - Ethernet, 3-162
 - for hardcopy, 3-170
- SHIFT button, 2-13
- Shift Register Generator command, 3-66
- shortcut controls, 2-15
- side menu buttons, 2-9
- sign(), 3-201

Signal edit process, 2-46
 signal output, 3-51
 signal output parameters, setting, 2-38
 sin(), 3-201
 sinc(), 3-201
 sinh(), 3-201
 size(), 3-205
 size, waveform record, 3-207
 Slope menu button, 3-47
 SMA cable
 Synchronous Operation, 3-250
 Smoothing
 quick edit, 3-101
 Specifications
 10MHz Reference clock input, A-18, A-19, A-35
 AC line power, A-21, A-37
 Arbitrary waveforms, A-2, A-28
 Auxiliary inputs, A-8, A-33
 Auxiliary outputs, A-5, A-31
 certification, A-25, A-40
 Clock generator, A-3, A-29
 compliances, A-25, A-40
 Cycle to Cycle Jitter, A-7, A-32
 Display, A-21, A-37
 Environmental, A-22, A-38
 Event input, A-18, A-35
 Extended Operation, A-2
 Filter, A-5, A-31
 Function Generator, A-20, A-36
 Installation requirements, A-22, A-38
 Interface connectors, A-21, A-37
 Internal trigger generator, A-3, A-29
 Main output, A-3, A-29
 Mechanical, A-23, A-39
 Operation modes, A-2, A-28
 Period Jitter, A-7, A-32
 Timer, A-21, A-37
 sqr(), 3-201
 sqrt(), 3-201
 Square math function, 3-72
 Square Root math function, 3-73
 srnd(), 3-201
 Standard
 network, 3-145
 standard accessories, 1-6
 Standard Waveform command, 3-59
 standby power, 1-12
 Start
 quick edit, 3-102
 starting/stopping waveform output, 3-53
 Status area
 Clock, 3-35
 Instrument, 3-35
 Run Mode, 3-35
 strobe, 3-126
 Style Fun, Style Name, Page# Sep
 Electrical, A-2, A-28
 Specifications, A-27
 Warranted Characteristics, Performance Conditions
 for, A-1, A-27
 Sub math function, 3-73

superpose, 3-131
 superpose parameters, 3-138
 Synchronous Operation
 Connecting the cables, 3-250
 restrictions, 3-250
 Synchronous Operation Mode, 3-249
 Sync-Master menu button, 3-50
 Sync-Slave menu button, 3-50
 Syntax
 BNF (Backus-Naur form), 3-185

T

T1.102
 network standard, 3-145
 TAA-
 disk application, 3-138
 TAA+
 disk application, 3-138
 Table editor
 editing table data, 3-106
 opening the editor, 3-105
 Table Jump, 3-125
 Table Type field, 3-83
 tan(), 3-201
 tanh(), 3-201
 Target field, 3-97
 TDS.ISF to Waveform
 File Conversion, 3-220
 TDS.WFM to Waveform
 File Conversion, 3-219
 Test items
 performance verification, B-6, B-60
 text file to Waveform
 File Conversion, 3-220
 Text format
 sequence file, G-1
 text input, 2-14
 Theory of Operation, 2-41
 TIFF
 hardcopy format, 3-170
 TIFF COLOR
 hardcopy format, 3-170
 time(), 3-205
 timing, 3-126
 Tools menu button, 3-72, 3-87
 Total Points
 jitter composer application, 3-152
 Total points field, 3-83, 3-97
 tri(), 3-201
 Trigger impedance menu button, 3-47
 Trigger input tests
 performance verification, B-33, B-87
 trigger interval, setting, 3-48
 Trigger Level menu button, 3-47
 Trigger menu button, 3-34, 3-46
 Trigger Source menu button, 3-46
 Triggered menu button, 3-44
 Tutorial

- creating a sequence list, 2-70
- creating and editing waveforms, 2-56
- instrument setup, 2-51
- loading and outputting waveforms, 2-53
- quick editor functions, 2-63
- using the equation editor, 2-67

Tutorial equipment and accessories, 2-49

U

- Undo! menu button, 3-91, 3-111
- Undo, non-support
 - quick edit, 3-104
- unit buttons on keypad, 2-13
- Update Mode field, 3-84
- Update of floppy disk file list, 3-226, B-10, B-63
- Update OS Program, 3-179
- Update System Software, 3-179
- Update User Program, 3-179
- Use Code Table field, 3-97
- using external keyboard, 3-114
- using the equation editor, tutorial, 2-67
- UTIL window
 - floppy disk usage, 3-157
 - formatting a floppy disk, 3-157
 - general purpose knob direction, 3-156
 - instrument status, 3-158
 - keyboard keys, 3-156
 - keyboard setup, 3-155
 - overview, 3-155
- UTIL window overview, 3-155
 - instrument status, 3-158

V

- Variables (pre-defined)
 - clock, 3-205
 - fname.clock, 3-205
 - pi, 3-205
 - point(), 3-205
 - size, 3-205
 - time(), 3-205
- Variables (predefined)
 - fname.size, 3-205
- VCO OUT, 3-41
- VCO OUT output frequency tests
 - performance verification, B-48
- Vertical Invert command, 3-65
- Vertical menu button, 3-34, 3-38
- Vertical Scale command, 3-64
- Vertical Shift command, 3-63
- View
 - Waveform Mixing, 3-244
- View field, 3-83
- View menu button, 3-37, 3-244
- viewing a waveform, 2-37
- voltage settings, 1-11

W

- Wait Trigger field, 3-118, 3-123
- waveform editor screen, 3-55
- waveform editor screen elements, 3-56
- Waveform Functions menu button, 3-111
- waveform loading restrictions, 3-36
- waveform memory, edit buffer, 2-36
- Waveform Mixing
 - Change the mode, 3-242
- Waveform Mixing menu button, 3-50
- Waveform Mixing Mode, 3-241
- waveform output, 2-39
- Waveform programming language, 3-185
- waveform sequences, tutorial, 2-70
- Waveform to Pattern
 - File Conversion, 3-221
- Waveform to text file
 - File Conversion, 3-221
- Waveform to text file with marker
 - File Conversion, 3-221
- waveform, viewing, 2-37
- Waveform/Sequence menu button, 3-34, 3-35
- Waveforms
 - samples in floppy disk, D-1
- Wfm Len
 - Waveform Mixing, 3-245
- Wfm Len menu button, 3-245
- Window menu button, 3-82, 3-91
- Window Operation
 - double windows, 3-230
- write(), 3-206

X

- XY View math function, 3-75, 3-80

Z

- Zoom/Pan menu button, 3-81, 3-91

